

# your computer

\$2.95\*  
NZ \$3.25

FEBRUARY 1985 MAGAZINE FOR BUSINESS AND PLEASURE

## NEW WAVES



**IBM PC-AT ★ OSBORNE 3 ★**  
**DATA GENERAL ONE ★ LABTAM DESKTOP**

Registered for posting as a publication. Publication No. NBP 4384. ISSN 0725-3931

# Draw your own conclusions with Roland

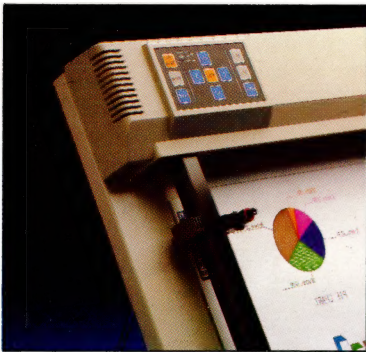

DXY 880 Control Panel



DXY 880 Plotter

DXY 800 Plotter

**A** picture is worth a thousand words. Faster, more effective communication means increased efficiency.

This applies to computers as well as people. Achieving fast, accurate and inexpensive graphics or charts, is what Roland plotters are all about.

For IBM PC, Apple and almost all other micro-computers, Roland plotters are the most cost efficient way of producing hard copy output and overhead transparencies, from business graphics or Computer Aided Design (CAD) drawings.

Whether you are looking for pictorial graphics from your Lotus 1-2-3, Symphony, Autocad or other popular business and professional software packages, Roland is your most cost effective choice.

**A** Roland DXY plotter is available for most business and industry needs. The DXY 101 single pen plotter, being ideal for drafting and design purposes. The DXY 800

8-pen plotter for low cost, multi-color applications.

The newly released DXY 880, with its increased speed and accuracy (0.05mm), in-built buffer plus Hewlett-Packard (H-P 7470/7475) software compatibility, is ideal for most CAD and intricate business applications.

**A**ll units come with RS-232c and Centronics interfaces as standard, providing compatibility with most computers. Drivers are available for most popular software packages, and in fact, the new Roland DXY 880 is compatible with more software packages than any other plotter in the world.

Roland plotters operate either flat or standing, saving valuable bench space. A wide range of accessories are available, including water and oil based pens, special pen holders and an overhead transparency kit.

**R**oland's worldwide research and development ensures the optimum benefits in compatible products, all covered by Roland's 12 month guarantee. As well, every product is available at a very "user friendly" price.

#### **Roland Corporation Australia Pty. Ltd.**

39 Victoria Street, Fitzroy, Victoria 3065

Phone: (03) 417 1800 Tlx: 35276

23 Cross Street, Brookvale, New South Wales 2100

Phone: (02) 938 3911 Tlx: 27769

#### **Roland DG New Zealand**

3 Prosford Street, Ponsonby, Auckland 1, N.Z.

Phone: (9) 764753 Tlx: (74) 60518

**Roland DG**

# 3Com EtherSeries

## Local Network Communication for Personal Computers

**E**therSeries is a family of hardware and software communication products for increasing the productivity of personal computer users. EtherSeries networks provide

peripheral sharing, information access, and personal communications, saving you time and money.

### NETWORK HARDWARE

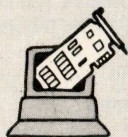

#### 3Com EtherLink

EtherLink connects your personal computer to Ethernet. It is a user installable plug-in plug-in board that incorporates the latest VLSI technology. Once you're "on the network", you are ready to take advantage of the EtherShare™, EtherPrint™, EtherMail™, and Remote EtherMail™ network services.

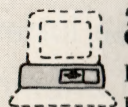

#### 3Com Network Servers

EtherSeries networks provide disk sharing, printer sharing, and electronic mail. These functions are provided by network servers, which are specially designated computers with disks and printers that the other computers can use.

EtherSeries, EtherLink, EtherShare, EtherPrint, EtherMail, Remote EtherMail, and 3Com are trademarks of 3Com Corporation.

### NETWORK SOFTWARE



#### 3Com EtherShare

The EtherShare software lets many personal computer users share the hard disk on a network server. The shared hard disk saves money and allows virtually all MS DOS software to be used with EtherShare.



#### 3Com EtherPrint

EtherPrint lets many personal computer users share the printer's capability and cost via the network.



#### 3Com EtherMail

EtherMail can be used to send messages and memos, even documents and files, to other personal computer users over the network. Judged the "Software Product of the Year" by *International Resource Development, Inc.*, EtherMail is powerful, yet easy to use electronic mail package.



#### 3Com Remote EtherMail

Personal computers not connected locally need not be excluded from electronic mail. The Remote EtherMail Software runs on a modem-equipped personal computer and links it to the network by phone.

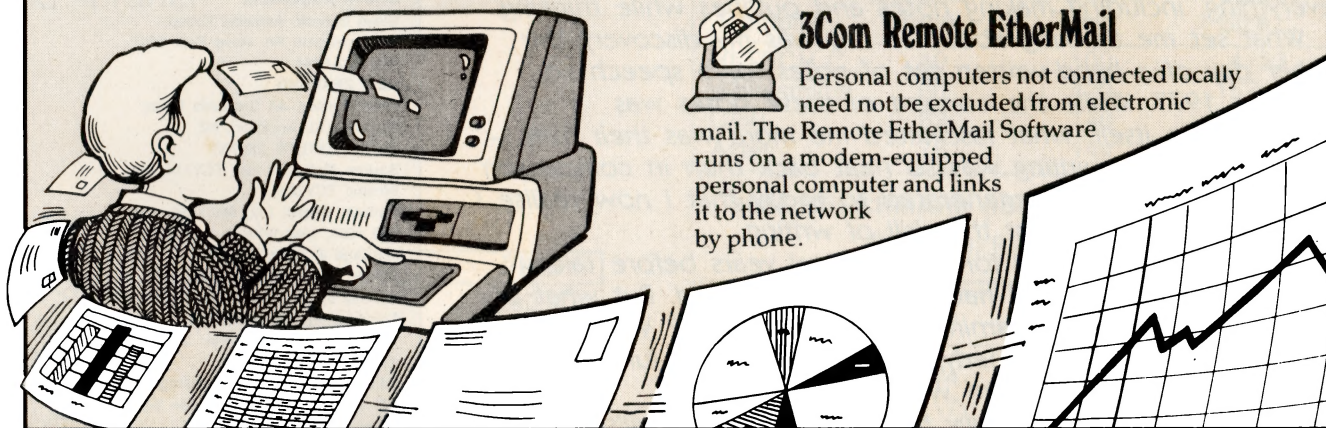

Available from all fine IBM PC outlets including the following:

BS Microcomp  
(03) 614 1433

Parity  
(02) 929 0900

All Computerland  
Stores



**IMAGINEERING™**  
"The Art of Software"

579 Harris Street, Ultimo, Sydney, NSW 2007  
Phone (02) 212 1411.

Sydney • Melbourne • Auckland • Los Angeles

All Myer Business  
Centres

Stott & Hoare  
(09) 322 4456

Management Technology  
(002) 34 4522

*The effects of the information revolution are becoming even more widespread than anticipated, and are affecting us in all kinds of insidious ways. I came across an example just the other day.*

*I have known for some time that I'm nowhere near as good at mental arithmetic – or even paper-and-pencil arithmetic – as I used to be. The calculator, which has now been around for more than ten years, has put paid to my abilities in that area. But I never dreamt I'd lose an even more fundamental skill.*

*In 1975 I got my start in the journalistic world when I joined the London office of 'Electronics Today International' magazine (where I had the specific brief of writing about these new-fangled microprocessors). In those days I couldn't type, but we had very accommodating typesetters who would accept hand-written copy, and I used to write all my stories by hand.*

*It wasn't long before I was given one of the office portable typewriters and told to master it. Despite previous experience of two-fingered typing on an ASR 33 teletype, I found the typewriter difficult to use and distracting, as I had to concentrate on the mechanics of typing and not on the subject matter. But I persevered and learnt my way around the keyboard.*

*Now I write sitting at a computer terminal, with all kinds of software aids and a word processing program that will forgive all kinds of typing errors and give me a second chance. My typing is neither speedy nor elegant, but I can at least type faster than I can think (don't jump to the wrong conclusion here!) and I now use a computer keyboard for virtually everything, including making notes and outlines while thinking.*

*What set me thinking about all this was my discovery the other day of a hand-written set of notes for a speech I'd given in 1977. While the content of these notes was interesting in itself, what fascinated me more was their form – hand-written. My writing was so neat back then in comparison to the scrawl I have degenerated to today that I now realise I have, at least partly, lost the skill of writing.*

*Now, I'd been writing for quite a few years before taking up typing, so it's an old habit that is dying hard. But what of our children who are learning to type in school? Will they never learn to write properly, and how will they function when there is no keyboard within reach?*

*We need to think carefully before abandoning skills which are not required under ideal conditions but may be needed in unforeseen circumstances.*

Les Bell

#### CONSULTING EDITOR

Les Bell

#### ASSISTANT EDITORS

Natalie Filatoff, Evan McHugh

#### NEWS EDITOR

Rose Vines

#### ART & DESIGN

Ali White

#### ART PRODUCTION

Sharon Hill, Vicki Jones, Brian Jones

#### AD PRODUCTION

Peter Maxwell

#### EDITOR-IN-CHIEF

Jane Mackenzie

#### MANAGING EDITOR

Jamieson Rowe

#### PUBLISHER

Michael Hannan

#### CONTRIBUTORS

Australia: Brendan Akhurst, Bill Bolton, Lloyd Borrett, David Brudenell, Geoff Cohen, Andrew Farrell, Frank Lee, Peter Lynden, Bruce Mitchell, Mike Newnham, John Nicholls, Tzu-Pei Chen, Jeff Richards, Rod Stevenson, Ernie Sugrue, Dom Swinkels, Bradley Thurkettle.  
United States: Howard A. Karten.

#### OFFICE SERVICES

Elizabeth Barnett

#### SUBSCRIPTION ENQUIRIES

Julie Plummer

#### ADVERTISING

David McDowell  
(National Advertising Manager)  
Damien Prins, Andrea Beaty  
(NSW Advertising)  
David Farrington  
(Victorian Advertising)

#### OFFICES

##### NSW

140 Joynton Ave, Waterloo 2017.  
(02) 663-9999  
Telex: FEDPUB AA74488

##### VICTORIA

150 Lonsdale St, Melbourne 3000.  
(03) 662-1222  
Telex: FEDPUB AA34340

##### WESTERN AUSTRALIA

Ian Greenacre, Gordon & Gotch Adv't,  
134-144 Parry St, Perth 6000.  
(09) 328-8044

##### QUEENSLAND

Craig Santilla, Media Services,  
4 Adelaide Terrace, Brisbane 4000.  
(07) 229-6033

##### SOUTH AUSTRALIA

Steve Birbeck, Admedia Group,  
24 Kensington Rd, Rose Park 5067.  
(08) 332-8144

##### NEW ZEALAND

Chris Horsley, 4A Symonds Court,  
Symonds St, Auckland, NZ.  
Telex: TEXTURE 260753

Source Mail: Les Bell TCY314; Matt Whelan TCY267.

Bulletin Board: (02) 662-1686 – Les Bell 1085; Matt Whelan 1; or leave a message in comments.

**YOUR COMPUTER** is published monthly by the Federal Publishing Company Pty Ltd. Printed by ESN – The Litho Centre, Waterloo 2017, phone (02) 662-8888.

#### Editorial and NSW Advertising:

140 Joynton Avenue, Waterloo 2017.  
Telex: FEDPUB AA74488.

Typeset by Hughes Phototype, Spit Junction NSW; phone (02) 960-2788.

Distributed nationally by Gordon & Gotch. Registered for posting as a publication – Publication No. NBP4384. See back page for information on copyright, contributions, reader services and subscriptions.

\*Recommended and maximum price only.

ISSN 0725-3931.

# HI-TECH C

An Australian developed C Compiler that runs rings around the opposition.

## Features:

- Compiles Full V7 C — including enums and structure operations
- Produces fast, compact code — outperforms all competitors.
- Complete I/O library
- Source for libraries included — no royalties
- Easy to use — one command compiles, assembles and links
- Powerful debugging tool included
- Command line I/O redirection
- FAST floating point
- Locally developed and supported
- Supports ROM-based software
- Includes MACRO assembler, linker and librarian

There are many C compilers now available for the Z80 and 8086 (or 808) processors; the quality ranges from terrible to quite good, and not all are available for both processors. Now there is a wholly Australian-developed compiler which outperforms all the others in all areas. HI-TECH C produces smaller, faster code than any other compiler for these processors, has a better user interface and provides features which are optional extras with the others. Furthermore, HI-TECH C delivers what we promise; although there is no such thing as bug-free software, we do not release unreliable products.

This is a solid production-quality compiler now being used by government departments, major Australian companies and many small companies and individuals. It is available for the Z80 and 8086/8088 processors, running under CP/M-80, CP/M-86 and MS-DOS (or PC-DOS). Whether you are a commercial software developer or a hobbyist wanting to learn the most popular small-system language today, HI-TECH C can provide the answers to your needs.

## Z80 BENCHMARK (2Mhz Z80)

Program: Primes (Eratosthene's sieve)

Compiler	Execution Time	Compilation Time	Program Size
HI-TECH C	40	100	4153
Whitesmiths	60	420	15745
C/80	63	140	3584
Aztec	78	144	9168

## 8086 BENCHMARK (IBM PC under MS-DOS)

Program: Eight Queens

Compiler	Execution Time	Compilation Time	Program Size
HI-TECH C	14	105	4500
Lattice C	17	111	14000

Version	Price
Z80 CP/M	\$250.00
MS-DOS 2.xx	\$300.00
CP/M-86	\$300.00
Z80 and 8086	\$475.00
Manual only	\$ 25.00



## HI-TECH SOFTWARE

*The leading edge of Software Technology*

PO BOX 103, ALDERLEY, 4051, QLD.  
PHONE: (07) 353 3389

## SPECIALS



### IBM'S NEXT GENERATION

20

*Our IBM columnist has been living with the PC AT for more than a month now. Is it incompatible and bug-ridden? Is it really fast? Lloyd has the answers to those questions, and more . . .*

LLOYD BORRETT

### ANOTHER QUIET ACHIEVER

29

*Labtam is one local company which has built up an enviable reputation for quality and sophistication. Now it has repackaged its advanced designs in a stunning multi-user desktop.*

MATT WHELAN



### OSBORNE THREE

31

*Osborne Computer Corporation made the micro world jump when it released its first portable, the O-1. Now it has shown us the new generation, and it looks good!*

EVAN McHUGH



### DATA GENERAL/ONE

36

*Data General's entry into the portable market has set most US observers on their ears. IBM compatible, two drives, 24 by 80 display, and a whole lot more in a briefcase package . . .*

ROSE VINES

## FEATURES

### GIVE THIS CLEVER MAN A KNOWLEDGEMAN

17

*After a delay caused by the rescheduling of YC's production deadlines, we've come up with a winner in the Database Applications competition. Who gets a free copy of KnowledgeMan?*

ROSE VINES

### MSX MISSILE LAUNCHED

69

*Compatibility between machines from several manufacturers? The impossible dream? Not at the low end of the market, now that Microsoft's MSX standard is falling into place.*

MARTIN HAYMAN

### THE BIT-BUCKET

77

*A new, semi-regular feature designed to provide an overview of all the gear – both hard and soft – we think you'll want to know about, yet don't have the space to review fully.*

EVAN McHUGH

### THE RS-232 SOLUTION

94

*Taking his role as book editor (and the fact we've had him doing some black-box interfacing work lately) seriously, Evan looked at the good book of getting serial devices talking.*

EVAN McHUGH

### COME FLY WITH ME!

110

*Uncle Frank found Microsoft's Flight so Simulating he wrote a book about it. We bought the rights to the condensed version, and bring you this exclusive report.*

BIGGLES LEE



# your computer

Audited by  
Audit  
Bureau of  
Circulations  
**BBC**  
for period September 1 1983  
to March 31 1984  
AVERAGE NET PAID SALES  
per regular issue  
IN EXCESS OF  
**23,500**  
excluding unsold and free copies

## REVIEWS

### DEFEND YOURSELF WITH JANUS/ADA

38

*We're sure Les thinks that when the world blows up he and the computers will survive – so he's learning every tongue known to machine. This time it's the US Department Of Defence's creation, Ada.*

LES BELL

### WANG DIVES INTO IBM's POOL

48

*Wang says every secretary should have one – instead of an IBM typewriter. Its new, low-cost word processor is meant to spell the end of the golf-ball.*

EVAN McHUGH

### NORTHSTAR'S NEW DIMENSION

84

*One of the Silicon Valley 'oldies' has come up with a real answer to providing multi-user capability and the dreaded IBM compatibility.*

MATT WHELAN

### BEEMODEM GETS A PC OF THE ACTION

91

*Applied Technology's \$159 BeeModem is an attractive accessory for any PC owner, judging from the number of 'will it work' enquiries we get. Here's the answer . . .*

JIM ROWE

### AWA'S THORN IN COMMODORE'S SIDE?

96

*Yes, we left Evan alone in the office this month, so he had to do all the work. But in his spare time he relaxed with AWA's Amstrad, a great combiner of games and business capabilities.*

EVAN McHUGH

### SEGA – SUCCESS WITHOUT HYPE

100

*While Evan was doing all the work, Matt was playing games. Again. He loved the John Sands Sega SC3000H with its new keyboard (and joysticks, and steering wheel, and Safari Race, and . . .)*

MATT WHELAN



## YOUR BUSINESS COMPUTER

*After networking comes . . . networkers. They're people who work from home, and phone the results into the office on their company-supplied computers.*

*In the UK, Rank-Xerox has 43 volunteers working this way in an experimental program which may just be the beginning. London BBC contributor Sonia Beesley looks in on the program.*

*In this issue we also cover computing investments, a Milk Run management system, and the case of the Orphaned Computer – in which US correspondent Howard Karten explains what to do when your manufacturer goes to the wall . . .*



## COLUMNS

LOTUS HOTLINE	107
BBC	116
IBM	122
KAYPRO	124
OPERATING SYSTEM	126

## DEPARTMENTS

YOUR COMPUTER NEWS	8
TEXTFILE	121
CLASSIFIEDS	128
SERVICES	130

## Bee Buzzes Scandinavia

The Australian answer to microcomputing, Applied Technology's Microbee, has achieved a major coup in Sweden by being selected as one of the machines to fill that country's school department's education contract.

The Microbee succeeded where the likes of Apple, Apricot and Sinclair failed, and it now enjoys a contract that is worth around \$3 million in the first year. The contract can be considered as a worldwide endorsement for the Microbee and a significant confidence boost for those Australian states that supported the Microbee as an educational computer when Applied Technology was just a fledgling company.

"We're excited in a modest sort of way," said Owen Hill, Managing Director of Applied Technology. "There was a lot of effort involved in winning the tender; we had to modify the machine to suit their requirements." The modifications included setting up a hard disk Microbee network in just five days and transferring software between Sydney and Stockholm using the Bee's own Telcom communications package. The message from Applied Tech's dealer in Sweden, Bergsala Data, was that the company's success was largely due to its responsiveness to the demands of the Swedish Education Department.

Bergsala Data's Managing Director, Mr L-G Larsson, commented on the success, saying, "Among the approved computers Microbee was by far the most cost-efficient. We regard this success as a major breakthrough for Australian hi-tech and especially for Applied Technology." The importance of the announcement in Sweden is reflected by the reaction of the Swedish stock market. Shares in the Swedish company jumped up 70 per cent in value and Swedish bankers have contacted Owen Hill offering venture capital. Owen hopes to finance the Australian end with Australian venture capital and to produce as much of the product in Australia as possible, although he expects they may eventually be forced to produce sub-assemblies, as specific requirements may be best dealt with nearer to the actual sites.

Owen also expects an effect of the contract will be to make the company's operations much more professional than they

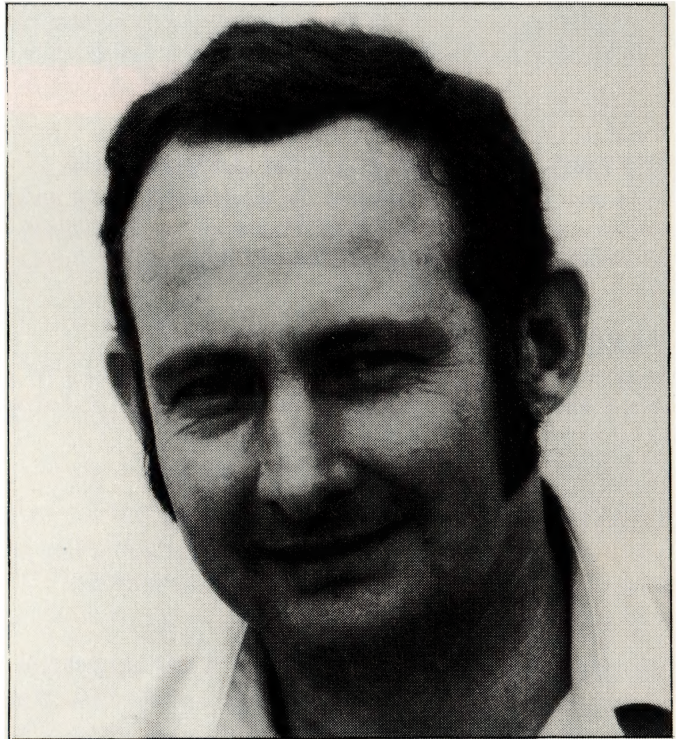

Managing Director of Applied Technology, Owen Hill.

have been in the past. Applied Technology will probably be taking a much closer look at production scheduling to achieve greater consistency in production and quality.

A spokesman for the Australian Department of Trade said the achievement carried special satisfaction for it. "It's one of those 'coals to Newcastle' cases. Sweden boasts being one of the smartest hi-tech countries in the world and we've been able to get up there with all the other competitors."

Australia's Trade Commissioner for Sweden, Mr W.F. Bridgestock, said the deal "re-emphasises the opportunities that exist for elaborately transformed Australian hi-technology products." □



### Low-cost multi-user System

SANYO OFFICE Machines has announced the release of BUSSS - Business System Solution - a multi-user business system that retails for under \$8000.

The basic package costs \$4995 and includes Sanyo's 8-bit MBC 1100 dual-drive micro, 20 cps daisywheel, SSS accounting and documentation.

For more information contact Sanyo Office Machines, Level 5, 5-9 Harbour View Crescent, Milsons Point 2061; (02) 929 4644. □

### Casio Winner Announced

A DOCTOR from Sydney has won the *Your Computer* subscription draw, which ran for four months last year. Twelve lucky subscribers received Casio PB-100 Personal Computers over the four months of the competition, while Dr Coates was the grand prizewinner in the final draw. Dr Coates' prize is a Casio PB-700 computer system, complete with FA-10 four-colour printer/plotter and CM-1 microcassette tape recorder, worth over \$1000 altogether. □

## ARCNet for All

DATAPOINT, producer and marketer of ARCNet, a local area network with over 6000 installations worldwide, has announced that it will open ARCNet to other manufacturers' standards with the aim of its becoming the industry-standard LAN.

First in line for compatibility is, of course, the IBM PC, but Datapoint says connections for Wang, Apple and other machines will be available sometime in the future. The company claims it will be easier and cheaper to connect PCs to IBM mainframes – and ultimately other companies' mainframes – using ARCNet than by any method IBM has yet devised.

The plan for opening up the ARC – called, with that American whimsy we've all come to know and love, ARCBlossom – works through the DOS-based INX (Information Network Executive) family of products. The first of these is the INX-PC, an adaptor card which fits into an

expansion slot of the IBM-PC bus. It contains its own processing power and memory, and is claimed to be installable by users.

Released by Datapoint at the same time as the ARCBlossom announcement was the 3200 computer, a 32-bit machine running with dual 68000 microprocessors. The operating system is UNOS, a UNIX lookalike that is 'friendlier' for applications users; software developers will be also able to run UNIX.

The 3200 caters for a maximum of 28 users, has an industry-standard bus that supports a wide variety of peripherals, and of course interfaces with ARCNet. As a first step in its drive to create an industry-standard LAN, Datapoint claims the 3200 can operate as the file server for terminals in the LAN, including IBM PCs using the INX adaptor card and the new PC8220 software.

For more information contact Datapoint, 157 Walker Street, North Sydney; (02) 922 3100. □



## Corvus Network Update

LOCAL Corvus distributor Horizon Computer Corporation has provided an update to the details on its Omnet network, covered in our November issue networks feature.

The major difference is the increased number of machines and operating systems supported. Microcomputer systems supported by Omnet are the Corvus Concept, Apple II and III, the Macintosh, DEC Rainbow 100, IBM/PC/XT/AT/Jnr, TI Professional, Zenith Z100 and most IBM compatibles. Operating systems supported are Apple-DOS 3.3, Pascal 1.2, CP/M 80, PRODOS, DEC CP/M86/80, MS-DOS 2.x, PC-DOS 2.x, MS-DOS 3.0, TI Professional DOS 1.25 and DOS 2.x, and Olivetti M24 DOS 2.x.

Corvus says it has the world's largest installed base of local area networks for micros, with 105,000 nodes on 15,000 networks. It not only produces local area networking systems and on-line mass storage and back-up systems for a wide variety of

microcomputers, but also sells a line of microcomputers designed primarily as personal workstations for use on Omnet.

Corvus produces Omnishare, a product which allows you to network an IBM-XT with five other PCs to share the XT hard disk. Constellation II, the company's network management software, allows you to mix different computer types and operating systems on the same network. There is provision for user 'log-on' and passwords; based on those names, the software manages access to different network devices and information contained on Omnidrives. It also supports semaphores to let a program share data by controlling access to common databases, and the printer server allows sharing of three printers on the network.

For further information contact Horizon Computer Corporation, 7-9 Merriwa Street, Gordon 2072; (02) 498 6611. □

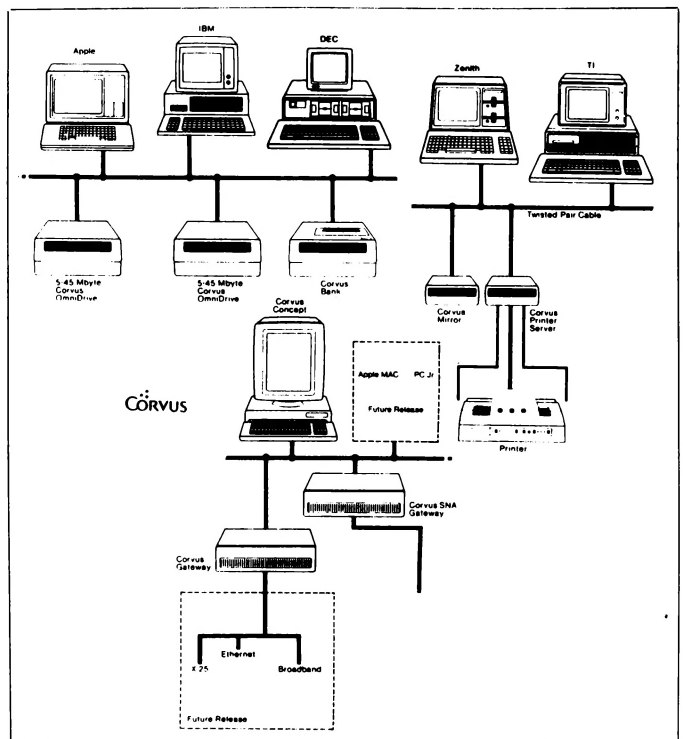

## Computers Lead Bowling Revival

ONCE A highly popular pastime, ten-pin bowling has lost much of its mass appeal in recent years. In an attempt to attract larger crowds and to make operations more efficient Sunshine Bowl, in Tweed Heads, has installed a Micromation computer and Wyse terminals on all the lanes.

The WS-100 computer terminals are housed in specially constructed seating and scoring consoles at the top of each bowling lane. The built-in keyboard has keys for 'strike', 'foul' and other scoring functions, and is designed for use by people with no keyboard experience.

The Micromation computer is at the heart of the system with a Winchester disk to back up each game in case of power failure and so players can check previous game scores. The operating system is MP/M

and M/Net with two Microsat/8 boards for lane control and management.

Because the system can run any standard CP/M software, the Sunshine Bowl also does all its word processing on the system and will soon include accounting and business functions.

The bowling applications software manages the allocation and booking of lanes, type of play (social or league), starting a lane, closing or aborting a lane, and the transfer from one lane to another during play.

Jeff Yates from Paravet Instruments – the supplier of the system – estimates a typical installation, with 16 lanes, would cost \$130,000. "We have had a lot of comments from bowlers about how it has vastly improved customer services and facilities, as well as making everything more accessible to



teams and individual bowlers," he said. "This system eliminates the possibility of any score-totalling errors or disputes over handicaps and averaging in team games. It does

all the complicated aspects of scoring automatically." For more information about the system, contact Jeff Yates at Paravet Instruments on (075) 31 7656. □

## Powerful Disk System for the Mac

AUSTOR Micro Systems is distributing Sunol Winchester disk systems for the Macintosh. Also available on the Apricot, IBM PC and compatibles and the Apple IIe, SunDisks range in size from ten to 92 megabytes (formatted), with up to four drives per controller and a transfer speed of 7.5 megabits per second.

In conjunction with SunMac, which interfaces the Applebus – using Apple's own networking protocol – and the SunDisk, it is possible to connect 32 devices on a network to share a single SunDisk. SunMac will also connect to SunNet, allowing the Macintosh to communicate with other microcomputers.

SunNet is reported to handle 64 users at a time, with seven different operating systems, while SunMac allows 31 Macintoshes to be networked through Applebus. Back-up facilities are available using the SunSave 21M random access cartridge.

Austor Micro Systems can be contacted at PO Box 558, Crows Nest 2065; (02) 922 2022. □

## Multi-user Sybiz Released

A NEW multi-user version of the popular Sybiz accounting software has been released by Sybiz Software. It is the first networked accounting software for 16-bit microcomputers to be produced by a major Australian software house.

Sybiz currently has an installed user base of 2500, and the company expects 25 per cent of those users to upgrade to the multi-user version. In addition, the company believes a new market will be opened up because the system will provide a viable alternative to users who might otherwise have to look at installing a minicomputer system.

To date, the system has been successfully tested on the ACTNet, PC-Net, X/Net and Ethernet, with no code changes needed. Record locking is built into the system. Peter Lucas, Software Director for Sybiz, says: "In theory, 38 terminals can be used at once. In practice this number is lower because of system degradation, and will depend on the type of use for each terminal. On a sophisti-

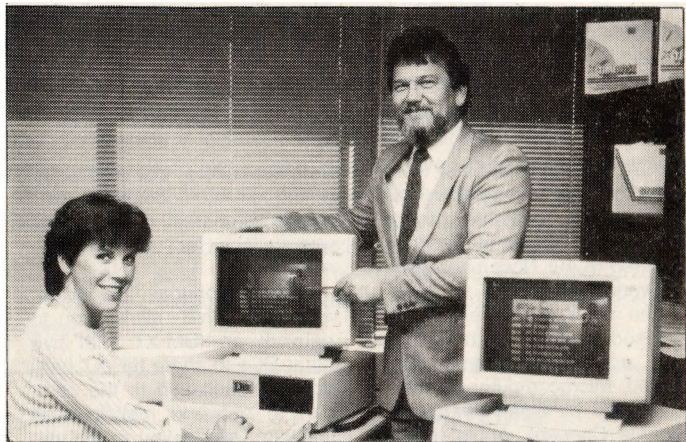

cated network, about twelve terminals is a practical expectation; on lower-speed networks, three to four terminals." The multi-user system involved about six months of rewriting for the software development team at Sybiz in Adelaide. The basic core of Sybiz needed little rewriting, but the outer applications programs required a lot of attention to accommodate the complex screen I/O routines necessary.

Derek Blair of Trackfast Computer, the Sydney distributor of Sybiz, believes the system is

six months ahead of others in Australia, and is confident the multi-user system will see an expansion of sales for Sybiz. Also in the pipeline is a (probably downmarket) version of Sybiz for the 512K Macintosh, written in Pascal.

Cost of upgrading to the multi-user Sybiz is \$1058 for the second terminal and \$529 for subsequent terminals. More information can be obtained from Trackfast Computer, 8 Cliff Street, Milsons Point 2061; (02) 957 6838. □

## Briefly . . .

■ 3M has developed a new process called 'Stretch Surface Recording', which uses slightly modified read-write heads moving just above the surface of the rotating recording media. As the tightly stretched media membrane 'dimples' beneath the head, it flings off debris in a trampoline-like manner, reportedly resulting in fewer errors and greater durability than conventional disks. More information from Cathy Smithson, 3M, (02) 498 9194. ▼

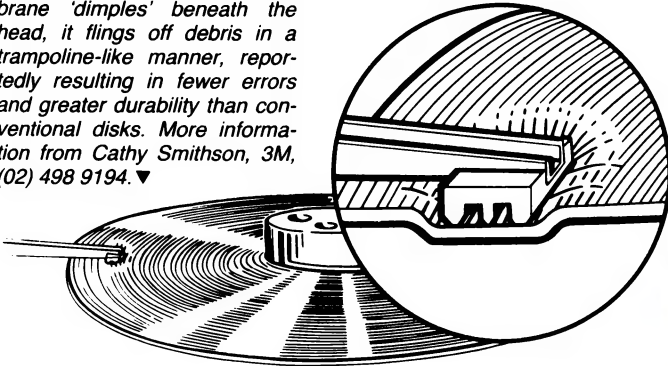

■ Jo Tech has released a hard disk with a swing arm which protects disks from head crashes caused by power surges or failures. Contact President Computers for more information: (02) 476 2700.

■ C.B. Solutions is offering a three-year on-site warranty for all Digital hardware, and a three-year telephone service on all software purchased from the company. The on-site warranty offers service on the purchaser's premises, providing they are within 50 km of one of Digital's 17 service centres throughout Australia. Contact C.B. Solutions on (02) 419 7588.

variety of business applications like mailing systems and information management systems. dProgrammer comes with complete listings of all programs and provides a menu-driven program generating facility. Contact the Software Shop for more information: (02) 451 1256.

■ The Software Shop is offering a suite of dBase II programs which provides an integrated double-entry accounting system with debtors, creditors and general ledger, and allows non-programmers to set up a wide

■ Commodore International has reported a 16.67 per cent sales increase in the September quarter of 1984 – traditionally the weakest quarter in the company's financial year. Worldwide sales hit \$A294.2 million compared to \$A252.2 million for the previous quarter. □

■ The PC Itoh Utilities package allows any C.Itoh printer, mono or colour, to be completely integrated with an IBM PC or compatible and its application software. The package of ten utilities comes on floppy disk, with a 50-page manual. Among the utilities provided are Epson and IBM printer emulation and screen dumps. Cost is \$99; Warburton Franki is at 7 Birnie Avenue, Lidcombe 2141.

■ Digital has expanded its professional workstation line with the release of the Professional 380. The system is reported to double the response and display rate of the company's previous high-end model, and comes with 512K RAM (expandable to 2M), monochrome monitor, keyboard and 10M hard disk for \$13,240. Contact Kate Castle, (02) 412 5269, for more information. ▶

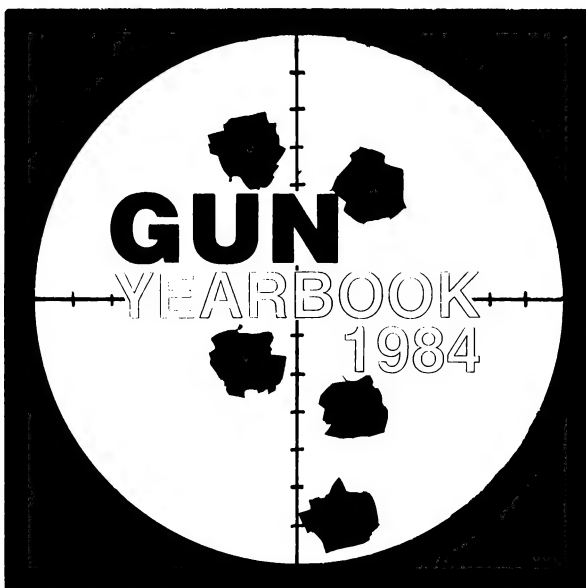

## ZERO IN FOR YOUR COPY

**\$3.50**

The 1984 GUN YEARBOOK has the features you want to read; from pistols of pure gold and hunting for grizzly bear, to interviews with some of the world's finest gunsmiths.

**So aim for your nearest newsagent and fire away!**

## LAN Alternative

AN ALTERNATIVE to traditional IBM PC networking has been announced by Alloy Computer Products. Called the PC-Slave, the product lets 31 users connect to a single IBM PC through a PC lookalike terminal and an extra card.

The card is the key, carrying an 8088 processor operating at 8 MHz, two serial ports and up to one megabyte of RAM. This means the slave terminals can operate at distances of up to 750 metres from the host PC. The terminals can have modems and printers connected to them locally or can access peripherals attached to the host.

Features supported by the

Real-Time Network Executive (RTNX) software include automatic file locking, IBM PC standard record locking, and the use of security passwords.

The cost of adding additional users to the system is about half that of an extra PC. The system's architecture means software can be used in a single-user configuration. One of the greatest claims the suppliers make for the PC-Slave is that the terminals operate at twice the speed of the host PC and at up to ten times the speed of many local area networks.

For more information contact Data Design Engineering, Suite 502, PRAN Central, 325 Chapel Street, Prahran 3181; (03) 51 5278.



## Computerise your Restaurant

MANAGE your restaurant by computer? It's now a possibility with the release of the Fisher Restaurant Management System, a set of comprehensive programs which performs the data processing functions unique to the business.

The Restaurant Management System consists of four modules - food cost/inventory control, accounts payable, accounts receivable and general ledger. The food cost/inventory control module provides key

management reports, including an inventory item list, menu item list, inventory variance, stock activity, gross profit and inventory re-order report.

The accounts payable module interfaces directly with the general ledger and food cost modules and allows a virtually unlimited number of vendors. The accounts receivable module was designed specifically for the food services industry, providing features necessary for handling house charge ac-

counts in a restaurant. On-line inquiry into each customer's master file, open invoices and period-to-date transactions are all available. It, too, interfaces directly to the general ledger.

A feature of the system is its ability to operate in multi-user mode, permitting three workstations to process information concurrently. The minimum hardware requirement for the multi-user version is 256K RAM with a 10M hard disk. The single-user version requires

128K and can run on a dual diskette drive system.

Fisher Business Systems is marketing the programs in conjunction with Drake Computer Systems (the latest division of Drake Personnel). A full range of services including hardware, software, service, supplies, rentals and, if necessary, staff to operate the equipment, is being offered. For more information contact Bill Carlson on (02) 264 1490 or Richard Ovenson on (02) 957 5888.

AT LAST

## A PRACTICAL PRINTER STAND



- Attractive smoky perspex
- Sturdy construction
- Space-saving design
- Realistic prices
- Made in Australia

Convenience, good looks and high quality are all built in  
Two sizes fit all popular desktop printers  
80 column 420mm x 350mm x 90mm  
136 column 620mm x 390mm x 110mm

**Order today (03) 439 6575.**

**Dealers enquiries welcome**

With the paper supply neatly contained within the stand, your area is cleaner, and your printer is instantly moveable - without leaving a paper trail.

To: Mac Designs, PO Box 59  
Diamond Creek, Vic. 3089

NAME \_\_\_\_\_

ADDRESS \_\_\_\_\_

Please send me

QTY	SIZE	PRICE	TOTAL
	80 Col	\$69	
	136 Col	\$97.50	

Prices inc. despatch

PAYMENT BY  Cheque  Money Order  Draft  Bankcard

Expiry Date \_\_\_\_\_ Signature \_\_\_\_\_

A division of  
D R McEwan  
& Assoc P/L  
(inc. in Vic.)

## Workshop on Women and Computing

A WORKSHOP entitled 'Women and Computing' will be held on February 23 in Sydney.

The workshop, at the Australian College of Physical Education and Dance, 57 Edwin Street, Croydon, is designed to give an overview of current teaching, training and opportunities for women in computing, to provide women with the chance to get a taste of 'hands-on' experience, and to develop a support and information network for women involved or interested in computing.

The programme for the workshop includes speakers on the history of women and computers, girls and computing in schools, tertiary training in com-

puter technology, life in the real world of the computer industry, demystification and examination of fears about computers, and social computer applications. An afternoon session will be devoted to hands-on use of computers, using the College's Datamax multi-user microcomputers and a variety of other 8-bit and 16-bit micros.

The workshop is being organised by the Sydney Women and Technology group (SWAT), and is open to all women. Childcare can be provided on request. For registration forms, SWAT, Box 214, Wentworth Building, University of Sydney 2006, or phone (02) 663 9999 ext 360 or (02) 451 6140.

# The Breeze Retail Point of Sale Software...

The 'Breeze' sophisticated micro-computer replaces the humble cash register, right at the Point Of Sale — and not only handles normal cash register functions faster and more efficiently, but also operates C.O.D.'s, Laybys, Account Sales and Payments, at the touch of a button.

The 'Breeze' is a breath of fresh air through your entire Point Of Sale operations — from the Point Of Sale flows the complete management functions of any business, including Stock Control, Sales Analysis, Accounts, Invoices, Statements, Sales Tax, Debtors Aged Balances, Sales Representative Commissions, even Banking Slips.

Your most junior cashier will find it a breeze to use, with the Credit Card and Bar Code Reader — because Breeze is specifically designed for fast customer service and accurate collection of data.

The 'Breeze' Software is available on the IBM PC & XT, IBM compatibles, Sirius & Apricot computers.

The 'Breeze' Retail Software System places all this vital information right at your very fingertips.



**improves your profitability  
as well as your  
lifestyle**

The 'Breeze' features:

- Cash, C.O.D., Layby and Account Sales
- Instant update of debtors accounts, inventory records, sales statistics, and sales tax as the sale is entered
- Full perpetual stock recording and reporting including stock reorder, stock status, and stock taking report
- Product sales analysis reports including margins
- Price lists
- Debtors aged trial balance
- Debtors statements
- C.O.D. deliveries listing
- Layby customer aged trial balance
- Overdue charges report
- Bank deposit report
- Magnetic credit card option
- Bar code reader option
- Inter computer communication option

The Breeze Benefits Summary:

- Easy installation
- Fast efficient operation
- 'User friendly' and easy to use
- Provides flexible and comprehensive management reporting
- Designed for future growth from diskettes to hard disk
- State of the art programming provides 'user selectable' systems options
- Thoroughly tested Software
- Comprehensive communication options
- Additional options — including bar code and magnetic stripe card readers
- Specifically designed for the Retail Point Of Sale environment.

The Breeze — a breath of fresh air for your business and your lifestyle.



**Breeze Software (Aust.) Pty. Ltd.**  
P.O. Box 1220, Geelong 3220.  
Telephone (052) 21 6144

**DIGITAL RAINBOW — A QUALITY COMPUTER & SUPERB KEYBOARD  
with  
DISK COMPATIBILITY BREAKTHROUGH!**



**SUPPORT** — From the largest manufacturer of mini-computers in the world.

**KEYBOARD** — Simply the best keyboard in the business. Try it and see for yourself.

**COMPATIBILITY** — Read, and write 24 "foreign" disks including IBM-PC, Osborne, Kaypro, TRS-80.

**QUALITY** — The highest standards and most aesthetic appeal of any computer — 12 months warranty.

All of these features are included **FREE OF CHARGE** with every Rainbow we sell, together with the famous **WPS-80 Word Processor** (just like the dedicated WPS-8 on the Decmate) and **MULTIPLAN** or **SUPERCALC**.

If you can't afford to buy it just yet — a **RENTAL PLAN** is also available.

**JUST SOFTWARE?**

For the RAINBOW we have available the full range of DIGITAL Classified Software, PLUS WPS-80 Word Processor, IMPORT!, MEDIA MASTER, AUTOCAD, LOGO TECHPAK (Civil Engineering) and more!

For the DECMATE we have the SWITCHMATE — run 3 x DECMATES off the one printer automatically — even Laser Printer.

For the IBM-PC we have the full range of what is available BUT at the lowest cost, PLUS Polywindows Desk (Clock, Calculator, Filedex, Calendar, Polykey, Memo) at \$95.00, MEDIA MASTER, XENO-COPY, APPLE TURNOVER and LOGO TECHPAK — and compatibles (including NCR Sigma Data and LOGITECH).

**LOGO**  
**Computer Centre**

**Word Processing, Disk Compatibility  
& Civil Engineering Specialists**

Suite 305, Henry Lawson Business Centre, Birkenhead Point, Harbourside, Drummoyne.  
Postal Address: P.O. Box 389, Drummoyne, N.S.W. 2047 Australia. Telephone (02) 819 7307





## The Great Aussie Software Writer

WOULDN'T YOU just love to walk out the door with \$15,000 worth of free computer gear? Well, you should have entered our Labtam Great Aussie Software competition!

You missed out, so this man – Simon Hiscox of Wantirna, Victoria – walked out of Federal Publishing's Melbourne office with all the goodies after being presented with the prize by Labtam chairman Don Dryden.

Some people have all the luck: this is Simon's second Labtam – he won a machine in a similar competition in 1983, run by another publication. Simon has decided to retire undefeated and leave the next competition open to those who don't already know the joys of living with a Labtam.

This time Simon collected a Model 3006 Labtam computer, plus a Mannesmann Tally MT160 printer (donated by Anderson Digital Equipment).

## EPSON QX-10

### The Human-compatible Personal Computer

Main RAM 192 Kb (Expandable to 256 Kb)

12" Green Monochrome High-Resolution Monitor 640x400 pixels

Two 5¼", Double-sided Double-density 48tpi Flexible Disk Drives  
Capacity: 320 Kb per disk.

with  
**EPSON RX-80 PRINTER**

**\$2750 (Sales Tax included)**

Reads & writes to 40 disk formats

#### Lots of Software:

- Lotus 1-2-3 • Supercalc 3 • Wordstar •
- Autocad • Multiplan • dBase II •
- IAL & Attache Accounts packs • Games •

## NEC

The new

- APC-III
- APC-Colour
- Pinwriter printers
- Spinwriter printers
- Networking

from \$2995

**FREE — EPSON RX-80  
PRINTER WITH EVERY  
NEC APC-III SOLD  
UNTIL 31-3-85**

## ALL STATES COMPUTERS

73 Dumaresq Street, Campbelltown 2560.

Telephone: (046) 27-1302



## RSI Moving Up-Market

THE PROFESSIONAL Officers' Association (POA) is preparing a number of legal actions for VDU-based repetitive strain injury (RSI) on behalf of a group that includes a chemist, an engineer, a tax assessor and a librarian, according to a delegate to a recent RSI seminar in Sydney.

The POA delegate, Santina Bertoni, said these were significant warnings of the spread of RSI among professional management, with research showing RSI was surfacing away

from traditional areas of keyboard operating. She predicted that many more instances will be reported as the number of VDUs, either installed in offices for operators or on executives' desks, increases.

Another speaker at the seminar, Richard Rawling, a specialist in ergonomics and industrial hygiene, said an overall approach to ergonomic planning, which included studies of job organisation and environment problems, was essential to the successful management of RSI. In the present stages of automated office technology it simply was not enough for man-

agement to introduce so-called 'ergonomic' chairs or keyboards to the workforce without considering job organisation and environment problems. He cited the State Electricity Commission of Victoria as a practical example of an organisation employing a broad approach to the problem, with a strategy based on the principles of industrial democracy and worker input for information where environment problems occurred.

Professor Frank Stevens, a legal specialist in workers' compensation, said employers should accept the fact that it is cheaper to introduce proper

work systems than pay damages. He said there were hundreds of cases in the Supreme Courts waiting on litigation, and the explosion of common law litigation, with high damages awarded, was hitting industry hard, driving some companies offshore. He also emphasised there was no high level of malingers, because compensation amounts were often insufficient for a claimant to live on, and also because cases took from four to five years to pass through the Supreme Court system. "That is a long time to be a malingere and to be idle," he said. □

## On the Road

A CARAVAN loaded with computers is being used by Footscray College of TAFE to promote the use of computers in the classrooms of Melbourne's western suburbs.

Schools will be able to have the caravan on-site for a day at a time, and college staff will use it to give hands-on in-service seminars for school staff. If the school wishes, the caravan will also be available after school to provide information sessions for parents.

According to Footscray TAFE's industrial liaison officer, Gerry O'Dowd, "This is the first serious attempt to take computer education to teachers. We are aiming at mass coverage, getting the service to all teachers in the region, not just one or two from each school."

The idea for using a caravan for this purpose came after the college introduced evening courses for home computers early in 1984. These were an instant success and the number of courses was doubled. Many teachers attended, but it was felt the courses were not really suitable, and so specially designed classes for teachers were prepared, and the caravan introduced, to reach as many teachers as possible.

Computers in the van are valued at \$7000, including Commodore 64s donated by the Technical Bookshop and some Sega SC3000s donated by John Sands Electronics. The service will be free to schools, and the college is looking for funding to maintain the programme. Anyone interested in the programme should contact the project co-ordinator, John Clarke, on (03) 688 3400. □

## Hard ACT for Apricot

LOCAL HARD disk manufacturer, Australian Computer and Telecommunications, has announced its complete line is now available for the Apricot computer under MS-DOS.

The disks come in various capacities and configurations up to 41 megabytes formatted. Also available are ACT subsystems, featuring the DMA Fixed/Removable Winchester hard disks, with average access times of 40 milliseconds, data transfer rate of five megabits per second and a complete warranty, of twelve months.

A 10M fixed disk costs \$3695 (including tax), and a 20M subsystem, with 10M fixed and 10M removable, costs \$5995. Other prices and more information from ACT on (02) 439 6300. □

## New Contender in the Integration Stakes

CULLINET Software Inc has entered the integrated software market with the announcement of Goldengate, a six-function package incorporating an information manager, spreadsheet, local relational database management system, document processing, full-colour business graphics and communications facilities, with IBM 3270 terminal emulation and asynchronous protocols.

Goldengate has been designed around 'core' software which controls memory management and integration between the different productivity tools. This design allows Goldengate to load only the tool that is needed, lessening the system's dependence on memory availability.

Cullinet's Dave Litwack believes this new approach provides fully functional individual tools without sacrificing integration. "Transitions between spreadsheet and graphics, for example, can be made truly 'on the fly', with no intimidating file or data transfer procedures needed."

Requirements for running Goldengate are an IBM PC with five megabyte hard disk, 320K RAM and IBM colour graphics card. The system costs \$940 (excluding tax), and is available from Cullinet Software, 88 Walker Street, North Sydney, 2060; (02) 957 3266. □

## Prices Gossip

YOUR COMPUTER, nose to the grindstone, ear to the ground, cheque books infinitely split between the chiropractor and the metaphor exchange, sees that there are a few upheavals on the horizon in the pricing of some components.

Take 64K DRAMs in quantity. Were \$3.75, soon \$1.50? How about 10M hard disks, the things the average hacker dreams about but could hardly scrape up the money to afford? They may soon be around the \$300 mark, with one megabyte floppies going for \$75.

These are the prices OEMs are soon likely to be paying for such commodities. Reasons offered by our sources are that a few big companies have gone to the wall and some other really big companies aren't selling machines in the quantities the makers of the peripherals thought they would. So there are all these hard disk, floppies and what-not with no one to buy them. The gossip goes on that there may well be quite a few double-disk-drive computers with all the memory you want for under \$1000. And they said the computer revolution was settling down. □

## Computer Protection

A RECENTLY established company, Computer Shield, is offering a computer protection plan to owners of new and second-hand computer equipment.

The plan provides general cover for loss by fire, accidental and malicious damage, and mechanical and electrical breakdown. There is also a maintenance contract that includes labour and parts involved in repair or replacement.

Computer Shield can be contacted at 3rd Floor, 582 St. Kilda Road, Melbourne 3004; (03) 51 5242. □

# Give this clever man a KNOWLEDGEMAN

AFTER BURNING the midnight oil (and missing January's deadline), our judges have finally reached a decision on the winner of the Database Applications Competition.

We were looking for an interesting and innovative use for a database management program, something novel and useful. Bill McKinley's idea for a system which caters to the whims of the well-to-do hit the mark, and has won him the prize, the KnowledgeMan Database System.

## The Winner

Bill, from Annerley in Queensland, described his system succinctly:

"The rich and powerful of our society often expect those who serve them to remember all their quirks, habits and foibles. It would be simple to use a database program to assist those who have to deal with a large number of influential people. For example, ship's stewards would no doubt find an advantage in being able to call up, at a second's notice, the details of their charge's after-dinner requirements, and so on."

This system seized the imagination of our judges, and was definitely the most original application suggested.

## The Field

The other entries covered a lot of ground, with a few types of applications cropping up repeatedly. The major categories of databases suggested were farm and livestock management, scoring systems, school record keeping, genealogy, plant catalogues, medical systems and computer file maintenance.

There were also some highly specialised applications, a couple of fantasies and one existential *cri de coeur* which, unfortunately, fell on deaf ears.

One of the more interesting entries was Ron Slaughter's 'Politcom System', designed to send semi-personalised letters to a politician's constituents. This

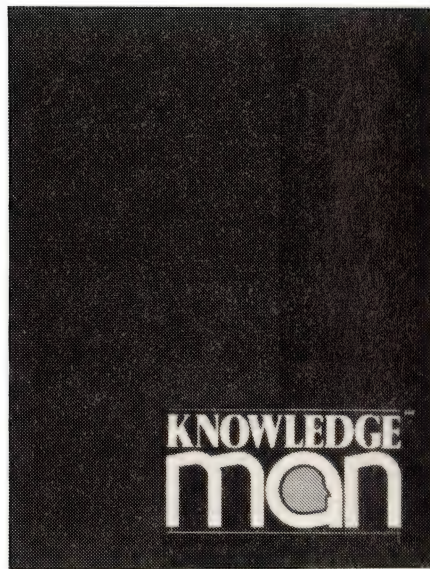

'vote bank' works by politicians and their staff keeping tabs on all contact with voters, including any personal details elicited (such as kids' names, hobbies), and then producing letters incorporating these details at election time.

M.J. Donaldson of Mt. Isa described a system for maintaining historical details of mineral exploration, which would minimise leaseholders repeating work previously carried out on a mining claim (although it seems like this would require pretty hefty hardware to maintain efficiently). Steven Goschnick provided a detailed specification for a database to sort mailing lists according to Australia Post's 'National Pre-Sorting Plan'. As one who has written such a database program, struggling with Australia Post's outrageous monument to illogic, I sympathise with Steven's efforts.

Stephen Brazenor submitted an idea for a database to provide a Surgical Audit. This system keeps track of patient details and preoperative, operative and postoperative information, enabling hospitals to produce statistical analyses

of the significance of particular factors in the postoperative outcome. Another interesting medical usage was Peter Dawes' Disease Classification System, base on World Health Organisation standards.

## The Prize

As we found in our review in the September 1984 issue, KnowledgeMan is a powerful database package containing many of the features on the average dBase II user's 'wish list'. It runs on most computers using PC-DOS, MS-DOS or CP/M-86, with a minimum RAM of 192K and two 500K disk drives. In fact, most of KnowledgeMan's limitations come from the machine on which it is run, not the program's own innate limits.

KPaint integrates with KnowledgeMan to automate the process of screen and form design. Using KPaint you can set up your forms with a variety of special effects (your terminal permitting), including different screen colours, blinking fields, reverse video, invisible entry (which prevents data from being displayed as it is input) and warning bells on specified fields.

KGraph allows the production of high-resolution colour graphics with KnowledgeMan; you don't even need to exit from the spreadsheet to produce a graph. KGraph can produce bar graphs (clustered, stacked and three-dimensional), scatter diagrams, line graphs, area plots, pie charts and high-low-close graphs. It also enables the user to draw free-form diagrams, and symbols, logos or pictograms can be incorporated into the graphics. Split-screen graphing is supported, with up to four graphs appearing simultaneously on a single screen.

These three modules are all being presented to the winner by Database Management Services of Victoria. ┘

## For all small and Personal Business Management

*'Because nowadays fast and efficient retrieval and processing of information is paramount to the success and growth of a progressive organisation.'*

The **microbee Small Business Success Kit** is an ideal package for serious small business users who want more than just a 'big name' accounting machine. **microbees** 128 K of Dynamic RAM and dual **400K** disk drives process pages full of information in seconds. The **microbee** High resolution Amber Screen monitor and Dot Matrix or Daisy Wheel printers display and record your spread sheets and wordprocessing quickly and accurately.

**microbee's** now famous Bundled Software provides you with a comprehensive library of programs for all Small Business needs. Programs include Wordstar/Mailmerge 3.3, Microsoft Basic, Telcom Communications Package and a full range of support utilities training guides and tutorials.

128K **microbee**, dual 400K slim line floppy disk drives, Hi-res green screen monitor, bundled software and manuals . . . **\$1995** incl. sales tax.

With **microbee** dot matrix parallel printer and **microbee** Pro amber monitor . . . **\$2395** incl. sales tax.

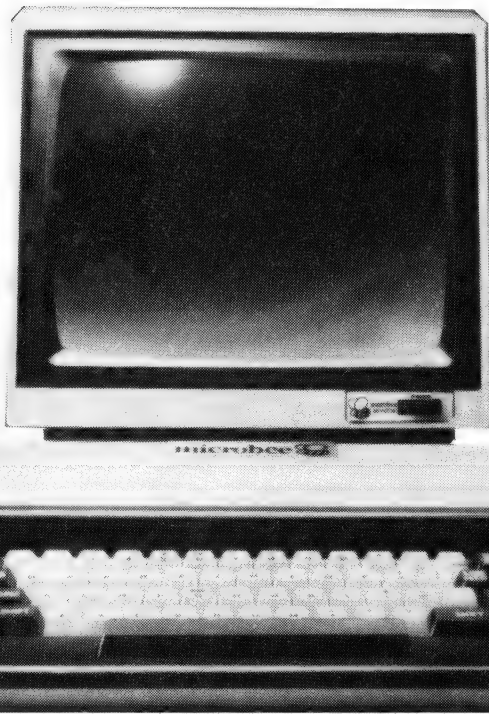

# A BEE FOR ALL REASONS

## For Education

*'Because Education is a Priority and your children deserve the best.'*

It is no coincidence that **microbee's** educational software is entitled "Learning Can Bee Fun". The **microbee** has proved that learning can be fun and by doing so has gained the endorsement of the Australian Schools Commission and the majority of Depts. of Education Australia wide, the Education Department in Israel, and more recently the Swedish Schools Dept have chosen **microbee** after months of stringent tests and stiff opposition from the big American, British and Swedish manufactures.

**microbee** is indeed Australia's own Educational Personal Computer, designed for the classroom and home with high quality graphics and sound effect capabilities, built-in software like Wordbee — wordprocessing, Microworld Basic — the **microbee's** own language and Telcom the communications package with a real time clock and alarm features.

## Educational Software Support

Your **microbee** is supported by an ever increasing range of high quality software developed and written by Australians especially for Australian schools and students. A full list of available teacher support resources for the **microbee** is available from your nearest **microbee** Technology Centre.

**microbee 16K Educator . . . \$449**

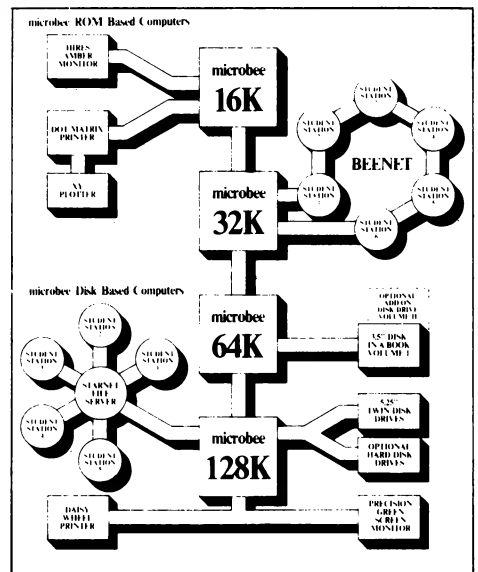

## For Communication

*'Because we need to communicate our ideas and data.'*

From home to office, around your network or around the world, with **microbee** you can tap into Bulletin

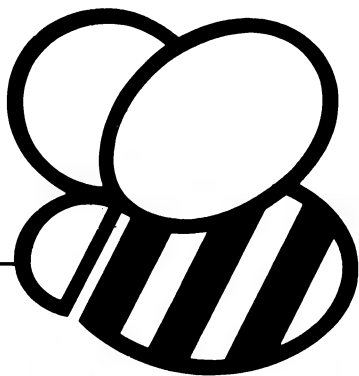

# microbee®



**DIRECT ORDERS**  
**PHONE (02) 487 2711**  
**TELEX AA72767**  
**APPLIED TECHNOLOGY**  
**RETAIL PTY LTD**

boards and benefit from Public Domain software.

Share your experience and learn from others treading the same path you choose.

microbee 32K  
Communicator  
Workstation . . . . **\$599.00**  
includes 32K microbee Series III  
and Hi-res Green Monitor.

Available separately:

microbee 32K Series III. . . \$499.00  
Hi-res.Green Monitor . . . \$149.50  
Hi-res.Amber Monitor . . . \$169.50  
Swivel Base . . . . . \$24.50



**NEW**  
**3.5" Disk**  
Computer  
-in-a-Book

The smartest new development in the Microcomputer World is the new high density low cost 3.5" Disk drive. Already standard on many 'big name' systems the 3.5" disk has the same or more capacity than the standard 5.25" disk, but occupies only 30% of the volume.

The microbee Computer-in-a-Book is available in matching volumes expandable to meet your growing needs.

microbee-Computer-in-a-Book  
VOLUME 1 includes microbee 64K,  
single 3.5" disk drive and software on  
diskette including Demonstration,  
MicroWorld Basic, Wordbee, Telcom  
and CP/M with Utilities — a  
matching manual is supplied.

**VOLUME 1 \$995.00**

**VOLUME 2 is an add-on disk drive  
in a matching volume**

**VOLUME 2 \$345.00**

## For experiments and personal development

*'Because microbee is the ideal Hackers micro'*

With a wealth of experiments and Hackers hints being published regularly in several enthusiasts magazines and one-shot publications. See the microbee Hackers Hand Book. Explore Robotics, Music and speech synthesis, tune into Weather map facsimiles and decode Radio Teletype information. The scope is limited only by your imagination.

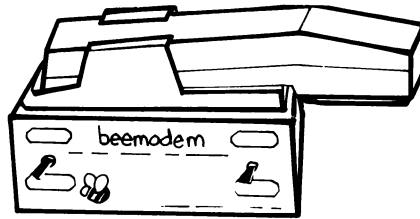

## For games and entertainment

*'Because playing is the root of all learning.'*

Fight in space, land a helicopter — explore the Dungeons of Khan, or is a challenging game of Chess more your speed. Whatever turns you on microbee's high resolution picture and

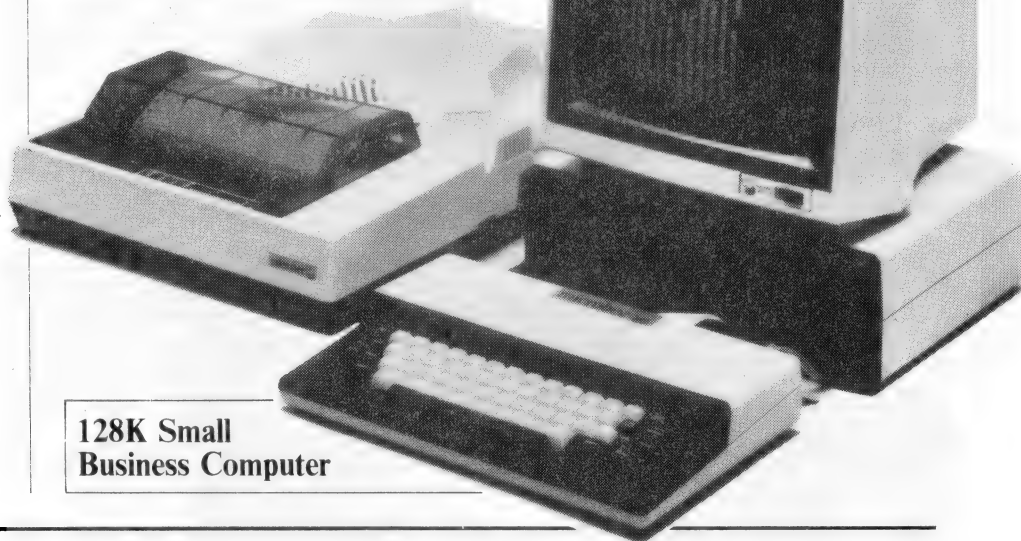

128K Small  
Business Computer

built-in sound effects will keep your microbee turned on for hours and hours everyday.

## Upgradeability

When you buy a microbee personal computer rest assured you have made the right decision. Your microbee will never become obsolete — on the contrary your microbee is fully upgradeable and can grow from 16K to 32K to 64K and even to 128K. Disk drives can be added as can a whole host of useful and interesting peripherals such as printers, plotters and modems. Whatever level you choose to start at your microbee will grow with you providing challenges and encouragement along the way.

## Quality Control and Service

microbee is designed and manufactured in Australia under strict computer controlled standards and is backed by a strong national service team operating from West Gosford and through microbee Technology Centres Australia wide.

### microbee technology centres

N.S.W.  
1 Patterson Ave, Waitara 2077, N.S.W.  
Phone (02) 487 2711

VIC.  
729 Glenferrie Rd, Hawthorn 3122, Vic.  
Phone (03) 819 5288

W.A.  
141 Stirling Highway, Nedlands, W.A.  
Phone (09) 386 8289

S.A.  
151 Unley Road, Unley 5061, S.A.  
Phone (08) 272 1384

QLD  
455 Logan Road, Stones Corner, 4120 Qld.  
Phone (07) 394 3688

FACTORY  
Koala Crescent, West Gosford 2250.  
Phone (043) 24 2711

### Authorised Dealers in:-

- Coffs Harbour (066) 52 7530
- Lismore (066) 21 8180
- Melbourne (03) 233 9665
- Townsville (077) 75 4000
- Cairns (070) 51 4341
- Milton (07) 371 6888
- Port Lincoln (086) 82 2666
- Mount Tom Price (091) 89 1383
- Launceston (003) 31 7890
- Wauchope (065) 85 3311

# IBM's NEXT GENERATION

*The IBM PC-AT had claims made for it on its release that it not only harnessed the most advanced technology (hence the 'AT') but also surpassed the original PC in both power and speed (not hard...). Since then there's been a fair bit of controversy about how good the AT is, and claims that it's suffering from too many bugs to be commercially useful. Lloyd Borrett took a look at one of the new machines.*

On August 14 1984, three years after the introduction of the first IBM Personal Computer, IBM US released the Personal Computer AT (for Advanced Technology). The PC-AT is an Intel 80286-based microcomputer that dwarfs the original PC in computational speed and power.

But not only did IBM release this new-generation microcomputer, it also announced three new operating systems (PC-DOS 3.0, PC-DOS 3.10 and XENIX), a local area network (PC Network), and a windowing environment (Topview). In the months since August there have been more announcements: Virtual Device Interface, Enhanced Graphics Board, and Professional Graphics Controller are just a few.

That is a *lot* for the industry to think about. To this day the sages of the microcomputer world are still trying to assimilate it all, but let me give you my brief version of what it all means. I'll start from scratch with the IBM PC-AT.

## IBM Listened

This is one very fast, well thought-out machine. I've had one since early November and I'm impressed. IBM has listened to many of the criticisms levelled at the original PC and done something about them.

A lot of people thought the original PC should have been based on the Intel 8086 chip instead of the 8088. Actually I thought it was a wise move at the time; the 8086 wasn't readily available, and more importantly nor

were the 16-bit bus support chips required. The chips necessary to build an 8-bit bus system based on the Intel 8088 were not only available, but a lot cheaper. The real criticism here is that IBM should have released an 8086 or 80186-based system twelve to eighteen months ago when the market was ready for it. Its opposition did.

Well, IBM has answered the opposition by leaping ahead to an Intel 80286-based system, the PC-AT. Forget that IBM says you can only have three megabytes of memory, because the 80286 chip can address 16M of memory, and AST Research has already announced a multi-function board with 256K, expandable to 3M. In fact, running in its native mode the 80286 can support four tasks, each of which can use one gigabyte of virtual memory; the chip has all the instructions necessary to perform the required memory management. But let's come back to earth.

## The Frilly Bits

The keyboard has been changed! Shock, horror! As a two-finger-and-thumbs typist, I actually *liked* the old keyboard. Quite a few people expressed other opinions, and IBM changed it. With over two years pecking out letters on the old keyboard the new one takes a little getting used to, but it *is* better. So there are now three keyboard layouts in use within the IBM's Personal Computer family: on the original PC, the 3270/PC, and the PC-AT.

Two of the really nice touches are the two-speed, temperature-controlled cooling fan and the lock. The new fan makes this system a lot quieter than any other member of the PC family, and in many office situations that can be a real blessing. When locked the PC-AT can be switched on but not used. The operating system won't boot, and the cover can't be removed. Once you're up and running, locking the system makes the keyboard inoperative.

Yes, I know these are but little frilly bits to many of you, but to those who use a computer for extended periods in the typical office environment they are quite important.

## The Meat in the AT

Okay, let's get to the meat of it. The PC-AT comes as two models. The base model gets one half-height 1.2M diskette drive and 256K of memory, while the up-market one gets an additional full-height 20M fixed disk drive, serial and parallel ports, and a total of 512K of memory.

Disk storage can be further extended by adding a second 20M fixed disk drive, or your choice of a second 1.2M diskette drive or a half-height 320/360K diskette drive. (There is every chance that someone will come up with a way to add a half-height 20M fixed disk drive when two half-height diskette drives are already installed.)

This next bit isn't as confusing as it may first sound: you can use the 1.2M diskette drive to read and write to 1.2M diskettes with the 1.2M format, but you can't read these diskettes in existing 320/360K diskette drives. Well, you'd expect that, wouldn't you? But get this. You can use 1.2M diskette drives to read and write to 320/360K diskettes with the 320/360K format. Now for the catch. Once a 1.2M diskette drive has written on a 320/360K diskette, that diskette *can't* be read in a 320/360K diskette drive.

As the PC-AT I'm using doesn't yet

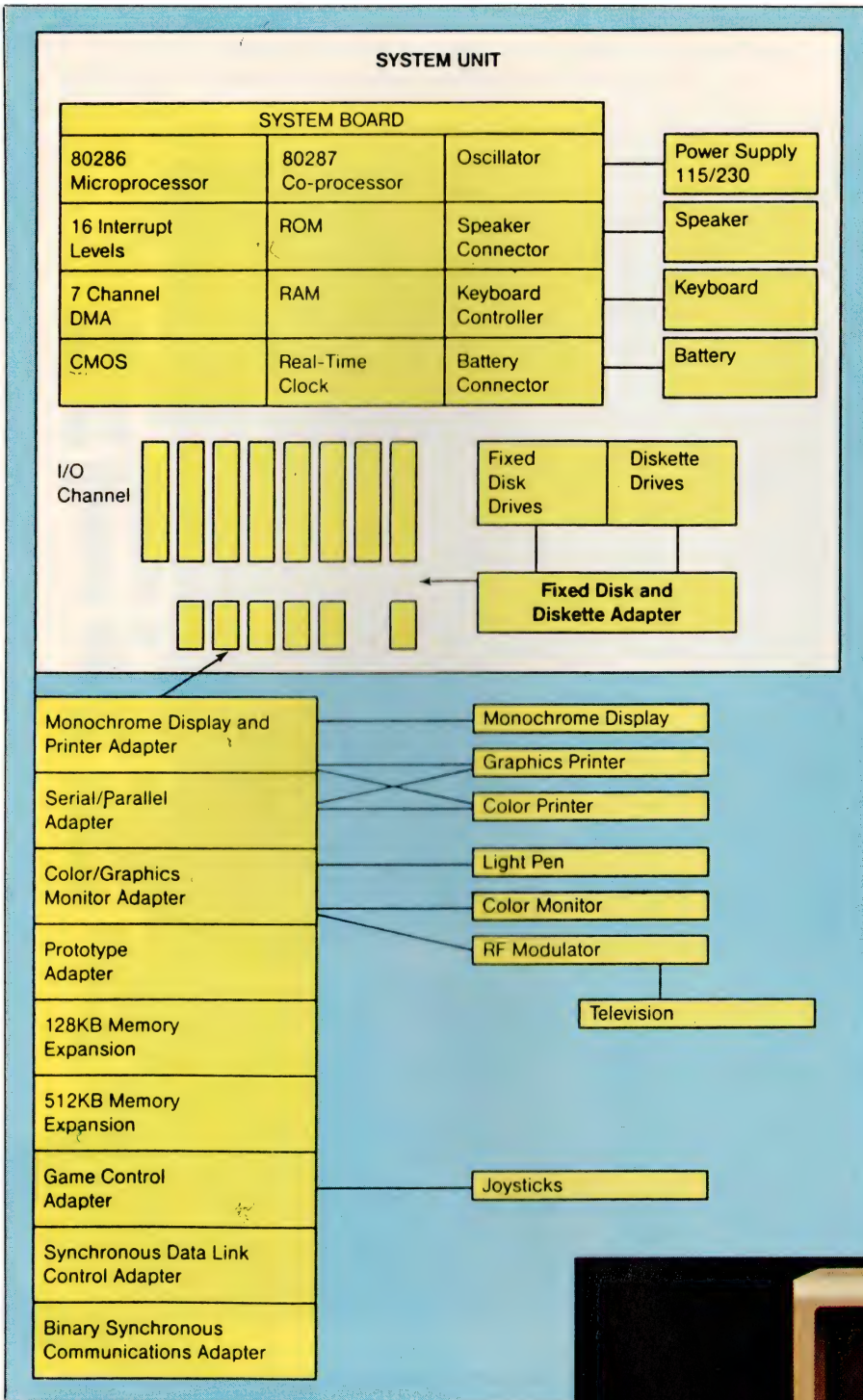

System diagram of the AT.

have a 320/360K diskette drive, and I like to move my work around between the various systems based on availability, that often eliminates the PC-AT from contention. Think carefully as to whether you should add a 320/360K diskette drive if buying a PC-AT; I would be very hesitant about adding a second 1.2M diskette drive.

The 512K of memory available on the motherboard is referred to as

base memory. To get 640K of base memory, as in the PC and PC-XT, an additional 16-bit bus 128K memory expansion card must be purchased. The 512K memory 16-bit bus memory expansion cards available from IBM go into the *extended* memory area above the one megabyte limit of an Intel 8088. Extended memory will be fully exploited by XENIX when it becomes available. PC-DOS 3.x can only use it as a RAM disk.

There are eight full-length expansion slots in the PC-AT. Six support both the old 8-bit and the new 16-bit bus, two support only the 8-bit bus. Some of the current option boards can only be used in the two 8-bit bus slots, while others can't be used at all. The IBM colour graphics adapter board is an example of one that must be in the 8-bit bus only slots.

The new combination parallel and serial adaptor uses the same 25-pin connector for the parallel port, but a 9-pin connector for the serial port! If only they were the other way round! I'll rarely use that parallel port, but now I've got to get special communications cables made up for the serial port.

The PC-AT uses a CMOS RAM and a rechargeable battery to store the hardware configuration, instead of switches on the motherboard. This saves having to open up the box and reset switches when different combinations are being tested. Believe me, there are times when you really wish you didn't have to keep taking the cover off and putting it back on. The battery also keeps the built-in calendar clock going.

### The Software

Now for the *really* important stuff, the software. To use the PC-AT, PC-DOS



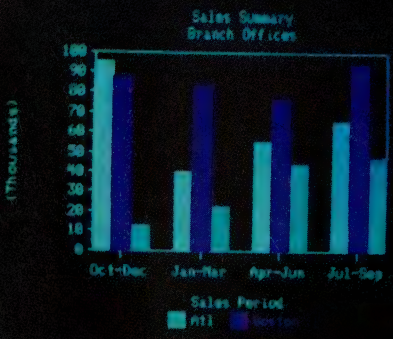

The Olivetti/AT&T personal computer is now ready for business.

It's a fast, flexible, reliable personal computer that is more than just a superior piece of hardware. Behind it is a commitment to a better way of managing information and communications. One that can pay off handsomely in increased productivity and profits. Because our PC is designed to be flexible enough to meet all your business needs — today and in the future.

Whether you use it as a stand-alone work station or in a fully integrated system, you'll find our PC a high performance machine. And a hard working addition to your office.

# INTRODUCING THE OLIVETTI AT&T PC. NOW THERE'S A REAL ALTERNATIVE.

Its fast processing and high resolution graphics will help make any computer task a computing pleasure. In addition, you can expect more standard features. More expansion slots. More options for future growth.

Our PC is also totally compatible with the MS-DOS operating system. It runs the most popular off-the-shelf software (including Symphony, Lotus 1-2-3, Framework and Flight Simulator) with no modification. Financial analysis. Forecasting. Budgeting. Word processing. Inventory. The Olivetti/AT&T PC does it all.

And its flexibility means that when it's time to expand, our PC will actually make your computer growing pains painless.

Finally, there is Olivetti's unmatched nationwide service and support. Always there when you need it.

MS-DOS and Flight Simulator are trade marks of Microsoft Corporation.  
Lotus 1-2-3 and Symphony are trade marks of Lotus Corporation.  
Framework is a trade mark of Ashton Tait.

**olivetti**  
Europe's Number One.

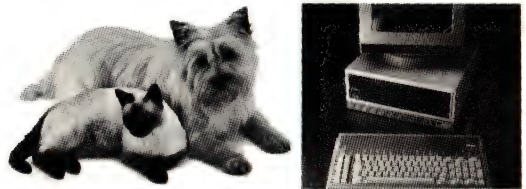

FRIENDLY & COMPATIBLE

To Olivetti, GPO Box 3993, Sydney, NSW, 2001.  
Telephone: (02) 358 2655.  
Sounds good. Send full details please   
Phone me

Name \_\_\_\_\_

Company \_\_\_\_\_

Address \_\_\_\_\_

\_\_\_\_\_ P/code \_\_\_\_\_

Business Phone \_\_\_\_\_

GREY/OLIV 0168

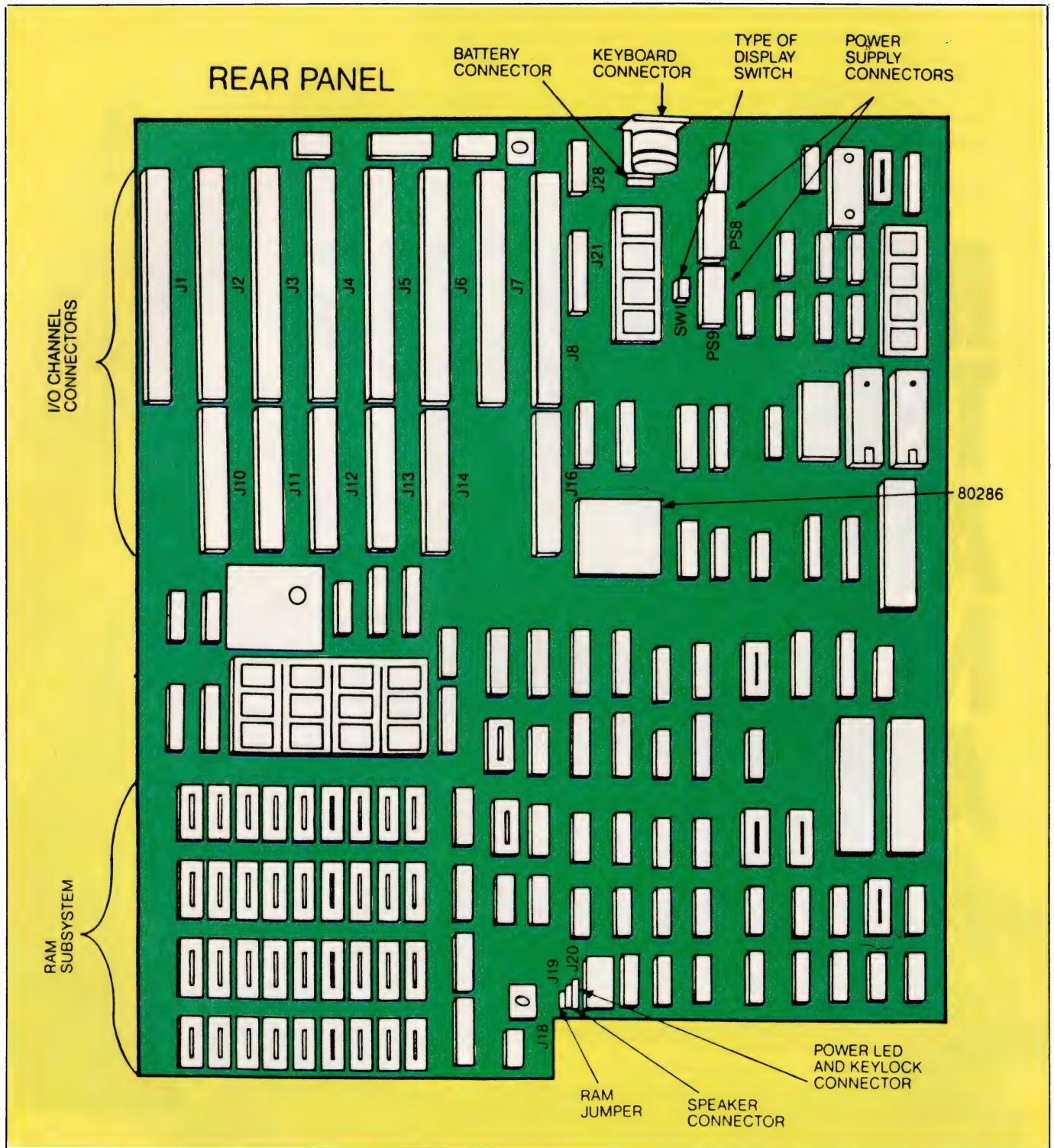

The AT's system board.

3.0 is required. It has the changes necessary to support the new 1.2M diskette drive, the 20M fixed disk drive, the calendar clock, and so on. There are a few nice additions to DOS 3.0, such as an IBM-supported RAMDISK driver, a change volume labels command, and an enhanced print command. The one I like the

most is the ability to use the COUNTRY= option in the CONFIG.SYS file to specify Australia. Most of the DOS commands then display the time and date in our format instead of the usual US format.

If you're an existing user of DOS 2.0 or 2.10, I wouldn't rush out and buy DOS 3.0; the few extra nice bits

aren't really worth the additional expenditure. Okay, you would get a few new features, but it also uses more memory. Wait, and buy DOS 3.10 when you want PC Network support later on.

**Incompatibility?**

Currently there is one big problem

with the PC-AT: not all the existing PC software will run on it. In fact quite a fair amount of it won't. But, in the words on the cover of that infamous book, DON'T PANIC.

This is a problem that has been coming for a long time. When a manufacturer provides the programmer with an operating system to access the hardware, it is expected that the programmer will use the interface defined by the operating system. But there are always programmers who are smarter than that, and for various reasons decide to bypass the operating system. In the case of the PC they either use the BIOS code in ROM on the motherboard, or go direct to the hardware itself.

These programmers can always justify why they do this. Strangely enough, they are also the first to complain when the manufacturer changes the rules, and their software stops working. In the PC-AT, IBM has made some significant hardware changes, and also changes to the ROM on the motherboard. Result scratch quite a few programs.

In most cases the reason the programs no longer work is that they are doing direct ROM BIOS and hardware calls in order to implement various copy protection mechanisms. The 1.2M diskette drive and 20M fixed disk drive required some major changes that have brought such programs unstuck. Those of you who already know my opinion of copy protection mechanisms will understand how this is giving me a warm feeling inside. I try to avoid programs that are protected, or can't be unprotected – all the programs I have in day-to-day use run on the PC-AT.

New 'fixed' versions of most programs that don't currently run on the PC-AT are in the pipeline;

<b>APPLICATION LAYER</b>
<b>PRESENTATION LAYER</b>
<b>SESSION LAYER</b>
<b>TRANSPORT LAYER</b>
<b>NETWORK LAYER</b>
<b>DATA LINK LAYER</b>
<b>PHYSICAL LAYER</b>
<b>The ISO System Interconnection Model.</b>

examples include Framework, dBase III and Symphony. But what's the bet these programs will still bypass the DOS interface? That means they are likely to get caught again real soon.

One good thing programs bypassing the DOS interface do is provide compatibility tests. Programs such as Microsoft's Flight Simulator and the Norton Utilities have been used by reviewers as the classic test as to how compatible XYZ's new lookalike really is. These same reviewers have used the fact that such programs have problems running on the PC-AT to write nice sensational stories about how incompatible the PC-AT is.

Apparently there have been problems with the 20M fixed disk drives on a few PC-ATs in the US, and that too makes great copy. Because IBM has such a long-standing reputation for not having such problems, any that surface are given wide coverage. At the same time, some rather fundamental problems with other systems are quite often glossed over. I know a number of other users of the PC-AT in Australia, and only one has had a problem – a faulty memory chip.

### It's Fast

Okay, I've already said the PC-AT is fast, and those who have used it would certainly agree. But how fast is it?

Well, all the benchmark tests I've done indicate that the AT outperforms the XT and PC by three to one on memory or calculation-intensive tasks. A specific example is a Lotus 1-2-3 spreadsheet that took 300 seconds to recalculate on the XT and only 110 seconds on the AT.

When comparing the I/O performance of the 20M fixed disk drive on the AT against the 10M fixed disk drive on the XT, the ratio is two to one. A read/write test of 5000 random records took 415 seconds to finish on the XT and 190 seconds on the AT.

### IBM's Local Area Network

I believe the most significant parts of the August announcements are PC Network and DOS 3.10. The network is an important strategic move for IBM, notable for what it does and doesn't do. First, it's not Ethernet. Second, it's not compatible with any of the other major contenders for the network crown. Third, it's a network

for PCs and true PC compatibles, not for other microcomputers. Fourth, it's not supported by XENIX. Finally, it's IBM's own interface.

PC Network is not IBM's planned overall token-passing network. It is a broadband-based PC network specifically designed to interconnect personal computers. IBM has promised there will be a gateway between the PC Network and the token-ring, cabling system-based network, and IBM has traditionally made good on such promises.

The broadband-based IBM PC Network was mostly built by Sytek, a Californian LAN specialist, but significant parts of the network's design are IBM's.

The board components are separated by the logical function they perform, roughly along the lines specified for the different layers of the open systems interconnection (OSI) model now being defined within the International Standards Organisation (ISO). By replacing the coaxial-cable electronics with circuitry for twisted-pair interface, and CSMA/CD control with token-passing, a similar board could accommodate IBM's proposed token-ring network.

It is significant that only layers three to five of the OSI model (network, transport and session levels) are Sytek-developed. While the network is open to software developers, the communications protocol embedded in layers three to five is the property of Sytek. Sytek technicians say there is no way anyone can build an interface card to the PC network without a licence to use that protocol or the IBM PC Network board itself.

The all-important layer seven (user/device/application interface level) is implemented via an 8K Network Basic Input/Output System (NETBIOS) ROM which IBM defined. So be wary of the recent Sytek advertisements which claim buying their product now is the same as buying IBM's PC Network.

IBM's PC Network is obviously aimed at its large competitors. Going with Ethernet or some *de facto* standard would have aided Xerox or another large vendor, so IBM chose to go its own way. It's not hard to guess they're hoping PC Network will become the new *de facto* standard.

What does this mean? Well, finally

**Which computer:  
supports 5 users  
Labnet networking system  
incorporates 8 & 16 bit processors  
800K floppy disk drive  
10 meg Winchester  
Concurrent CPM  
640K RAM  
has dual printer capabilities  
is delivered within 30 days from order  
and only costs \$8600\*?**



\*One monochromatic terminal provided only.

# **The Labtam 3003 desktop computer**

For further information contact:

Sydney: 411 2588, Melbourne: 587 1444, Queensland: 352 5166, Adelaide: 260 0133, Perth: 342 9721.

Grat-X D.A.G. L1933

we have a network standard. With the 17-odd NETBIOS commands and the PC-DOS 3.10 interface, IBM has defined how application programs should interface to a network. Until now each LAN supplier has had its own version of such an interface, even though many used the same hardware. Now IBM has turned the tables and said, in effect: "Here is the software interface, it will work regardless of the hardware we use".

Now the software developers can start writing programs which make use of a LAN's features. In my opinion we need effective networks a lot more than we need multi-user operating systems.

### **XENIX – the PC-AT UNIX**

XENIX is Microsoft's implementation of UNIX version 3. IBM has picked it up, fiddled with it a bit, and will make it available for owners of the PC-AT.

XENIX is not a multi-user PC-DOS; PC-DOS programs such as Lotus 1-2-3 will not run under the XENIX operating system. This is not the way to have three PC users running Lotus 1-2-3 and sharing the same disk files. The other two users on a XENIX-based system use a normal asynchronous terminal. That means *slow* screen updates.

XENIX does not support PC Network, and IBM has not announced any applications software to run under XENIX. These two points are most significant, and I believe IBM is not serious about XENIX. Why should it be? If IBM and others produce XENIX programs they will run on a host of other manufacturer's boxes, which is the last thing IBM wants.

IBM has released a lot of good software in the US which will run under PC-DOS and later make use of IBM's window solution, Topview – but it's released no XENIX software. XENIX has been made available for those educational institutions and software houses which have said they will use an IBM Personal Computer if they can have UNIX. Currently they mostly use a multitude of AFUBs (Another F..... UNIX Box) based around the Motorola 68000 chip. XENIX will bring them gradually into the IBM/Intel fold.

### **Topview Is The Future**

Another significant announcement back in August was IBM's windowing product, Topview. Note that once again it's IBM's product. IBM had a host of networking interfaces it could have used, but chose to develop its own. IBM could also have used other

windowing products, such as Microsoft Windows or Digital Research GEM, but once again developed its own.

Topview is one of the few windowing interfaces which does not require a graphics screen. This means the two-thirds of all PCs which only have a monochrome display can use Topview. How many PC owners would now pay out the money to buy another window program, as well as the graphics gear?

Topview allows a form of multi-tasking, communication between applications, and the use of a mouse. It provides the user with a consistent and productive interface (and I'll do anything to avoid that term 'user friendly').

IBM is pushing Topview. It has already announced programs that will run using Topview, and copies have been handed out to major software developers for evaluation. That hasn't happened with any previous PC product. All the comments I've seen from those who have used Topview are most favourable.

Software developers will now write their programs to use the I/O interface defined by Topview. As a result we will see better-quality programs, and a consistent user interface across all programs.

### **The Next Generation**

My prediction is that IBM will eventually drop support for Microsoft's DOS and XENIX some time after introducing a multi-user, multi-tasking PC Network and SNA-supporting version of Topview. Then IBM will have its own PC operating system. The compatible market will be in deep trouble.

In the past I've scoffed at predictions by others that something like this could happen, but the indications are now too clear. Microsoft will continue to put more and more effort into the Apple Macintosh, and will drop out of the PC market. The compatibles could be saved by a version of Concurrent DOS from Digital Research which has support for PC Network and Topview; I believe DR is the only software house with the expertise necessary to do it. What worries me is that DR is currently concentrating on UNIX development with AT&T, and there are rumours that AT&T may buy out DR.

IBM has shown us the next generation in hardware, and it looks good. I believe it has also indicated what the next generation in software will be. It too looks good, but a few people are going to get both themselves and others in trouble if they continue up the XENIX/UNIX path. □

## **AT Under Attack**

NEWS FILTERING from the US seems to suggest there is some discontent with IBM's whiz-bang AT (Advanced Technology) computer. The AT uses the Intel 80286 chip with up to three megabytes of user memory and 41.2M of on-line storage, and is supposed to be compatible with most existing IBM Personal Computer hardware and software.

Complaints about the AT have centred around a high number of system crashes and software incompatibility with the IBM PC. IBM denies there is a software compatibility problem, but has admitted there are problems with the hard disks which have been shipped.

Ric Einstein, IBM's Australian Product Manager, Personal Computers, says there has been a "higher than expected" failure rate with the hard disks. "IBM has a policy of zero defects, which is why we are known for our reliability. We are working on the problem and a solution is expected soon." It's not too clear if the solution will be found before the AT is released in Australia. IBM does not like to give advance dates of product releases, and when asked if the Australian version will be free of the known disk defects, Mr Einstein didn't wish to comment on whether the release date would be dependent on a solution being found, saying: "Even if the AT is released here before the solution has been found, we will be aware of the problem and prepared to act." This will be comforting news for prospective purchasers . . .

As far as software compatibility goes, Mr Einstein suggested problems reported from some sources in the US might be due more to a lack of understanding on the part of users, rather than any hardware or software problem. "The AT has been designed for highly complex tasks, including scientific and engineering applications, PC-Net, Topview and Display Writer," he said. "If someone tries to take a program like Lotus and run it under Topview, it's quite likely they might have problems working with the software in that new set-up." He added that the vast majority of "well-written" (his words, not defined) programs for the IBM PC which are not timing dependent should run on the AT. □

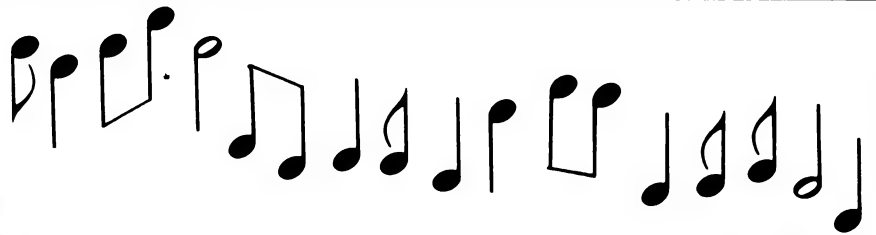

on a  
Baby Grand?



Baby Grand courtesy R.H. Elvy P/L

## OSBORNE 3 Can

... and LOTUS  and dBase II and Wordstar and Multiplan and any other IBM music you care to compose.

The OSBORNE 3 ULTRAPORTABLE is 4.3kg of 16 bit IBM compatibility that will run all industry standard MSDOS software. Utilising DOS Ver.2.11A and two 360K integral 5¼" floppy disk drives, it makes all other compatible portables look very incompatible and a lot less portable.

### FEATURES

80C86 16 bit Microprocessor  
128K-512 RAM  
Built-in clock/calendar,  
calculator and diary. Optional  
built-in modem.

Two 5¼" standard floppy disk  
drives. 1 Serial, 1 Centronics  
port, 63 alphanumeric keys,  
IBM styled keyboard.

25-Line Screen format with  
16 line Auto-windowing  
display.  
AC/DC power supply. Special  
function keys and software  
built in.

**"AFTER TODAY ALL OTHER PORTABLES ARE PLAYING THE WRONG TUNE"**

**OSBORNE 3**

*The company that invented the portable, invents the ultraportable.*

OSBORNE AUSTRALIA, 93 York Street, Sydney, 2000. Telephone (02) 290 1122

# ANOTHER QUIET ACHIEVER

LABTAM INTERNATIONAL, the local manufacturer which has quietly built up a reputation for building top-class machines, is about to jump into the limelight with a stunning multi-user desktop.

The Melbourne-based company, which was founded in 1972 as a scientific instrument maker, has been expanding rapidly with significant international sales for its multi-processor, multi-operating system floor-mounted 'tower' units.

The machines, which feature eight, sixteen and 32-bit processors and run operating systems from CP/M-80 to Unix, are recognised as high-quality, high-speed top-end micros.

The new 3003 packages the current Labtam technology into a pyramid-design desktop which looks like a personal computer but behaves more like a supermicro.

And it's a value-for-money package that makes current desktops like the IBM PC-XT look a little sad. The 3003DT will sell for \$8600 and includes eight and 16-bit processors, an 800K minifloppy, 10M hard disk, 640K of RAM, 10 I/O ports for peripheral connections, a bit-mapped REGIS graphics display of 800 by 300 resolution and the Labtam ergonomic keyboard.

The machine will run Concurrent CP/M, supporting up to five users with the only extra outlay required being the purchase of terminals for each user. The Labtam has 'dynamic terminal allocation', which means any time you want to add a terminal you simply plug it into the port mounted on the back panel and press one key on the keyboard. The Labtam



*Labtam's new desktop computer runs various operating systems, 8-bit and 16-bit software and, with the addition of terminals, supports multi-user operation. Matt Whelan took a brief look at one of the first of them.*

reconfigures itself to optimise its operation for the number of terminals installed.

In the multi-user environment, the 3003DT allows an 8-bit job to be running at the same time others are running 16-bit jobs. Users with a significant current investment in 8-bit software, and who would like to switch over gradually to 16-bit, will find this feature attractive.

Connections on the Labtam back panel already include ports for

networking, as well as light pens, joysticks (all work and no play...), a mouse interface and parallel input and Centronics printer output.

The machine will run MS-DOS in single-user mode.

The 3003 uses a 3-slot Multibus for all 8/16-bit operations and all I/O devices.

It's an impressive-looking machine. We'll report further when we've had a closer look...



# KANnet

A REAL NETWORK

The KANnet is one of the most advanced and flexible Local Area Networks designed for microcomputers. The major features of this high performance LAN are:

- Runs unmodified single user software with automatic protection of shared data, thereby allowing single user programs to run in a multi-user environment.
- Flexible and total sharing of any resource on any computer.
- Supports a mixture of computer types and operating systems on the same network, including IBM & Compatibles.
- Multiple modem and terminal emulation support.
- Priority levels and independent read/write passwords.
- Electronic mail and interactive computer-to-computer communications.
- Gateways to other networks.
- Ease of use as network procedures can be fully automated.
- Up to 254 computers on the one network and still maintain performance.
- Any number of computers may be powered up or down without affecting the network.
- A distance of 2000 metres between two adjacent powered computers is permitted.
- Automatic recovery on re-cabling of broken connection.
- No central file or print servers required.

**ENTERCOM**  
COMPUTER CO.

SPECIALISING IN HARD DISK/NETWORKING SYSTEMS AND COMPUTER AIDED DESIGN.  
For further details & the location of your nearest trained dealer contact ENTERCOM COMPUTER CO.  
136 BRIDGE RD. RICHMOND 3121 MELBOURNE, AUSTRALIA. PHONE: (03) 429 9888 TELEX: 30625 ME 1400

# OSBORNE THREE



*The evolutionary process in portable computing is almost complete.*

*The ultimate solution to the problems of combining compactness with power is not far off and several machines coming onto the market at the moment have nearly all the desired attributes.*

*Evan McHugh looks at one of them, the Osborne 3.*

**WHAT ARE** the attributes people look for in a portable computer? First, the machine must be truly portable – able to be lifted and carried by the average person over reasonable distances without discomfort. Next, there must be a large memory – at least 128 kilobytes, with room for expansion – to run all the memory-hungry popular packages, especially spreadsheets. There must be on-line memory storage built in, such as floppy disks – preferably two floppies, or, as may be the case in the near future, a floppy and a small hard disk. Finally, the screen should be large and readable. The resolution on

the average VDU lets you see 80 characters by 25 lines and it is expected that the ultimate portable will have a similar display.

The exciting thing about the Osborne 3 is that it comes very close to fitting those specifications. It is not easy to fit all the capabilities and requirements mentioned into a small, easily transported package; after all, only a few years ago such a machine would have filled a room. The Osborne 3, however, takes up very little space and packs a lot of computing power into the space it does use. The resulting machine comes very close to being an ideal computer.

## Hardware

The screen is perhaps the main limitation in an otherwise commendable product. It is a readable liquid crystal display – no better. The problems of viewing LCDs are well known and are present on this machine, but the adjustability of the screen helps reduce the problem; you learn quickly how to manipulate the screen to make it at least legible. The size of the display is 80 characters by 16 lines, which, while it's quite good for an LCD, is a mental step-down from the more common larger screens, and some people might find the adjustment annoying.

The good news with the screen is that there will be an upgrade to a larger version. On our review model there was an indentation below the screen, which seems to indicate that space has already been made for this new one. However, even as it stands the screen is quite easy to use with word processing and spreadsheets, so unless it's in constant use it may not prove too much of a problem.

On the positive side, at all times during operation the screen was as steady as a rock.

One difference with the Osborne is that the screen is fixed while the keyboard swivels up and down. This means you can't adjust the screen viewing angle and instead have to adjust your height in relation to the computer, which may lead to arm strain when you use the keyboard.

The keyboard itself is very pleasant to use. The profile is quite low, the rows are tiered and the feedback from the keys is firm and direct. I found I could type quite quickly and rest my wrists on the table while still keeping my fingers on the home keys.

The keyboard has the standard qwerty layout with a few extra keys, and some keys that serve in a dual role. There are ten programmable function keys, plus keys to call up some ROM functions. One of the ROM functions is a calculator, which, while in use, takes over some of the standard letters to double up as a numeric keypad. These keys are indicated by light blue lettering in their bottom right-hand corners. Arithmetic operators and memory instructions are also displayed on



The unit we tested has two 360K IBM standard disk drives.

either side of the keypad. And joy of joys, the four cursor keys can be used in applications such as Wordstar.

You can choose the configuration of drives with the machine. The basic computer has one drive, with an extra one costing around \$350. The drives are 360K IBM format – they could have been bigger, but that would have robbed the Osborne of one of its main features, PC software compatibility. Osborne has already discovered, in no uncertain terms, the dangers of failing to keep up with market demands.

The basic machine comes with 128K of memory, which can be expanded to 256K or 512K. The processor is a CMOS technology version of the 8086, an 80C86 operating at 3.5 MHz; this forms the basis from which the machine derives its measure of IBM compatibility. There is also a built-in 300-baud modem, although it is Bell standard.

## Software

Being an IBM compatible, the Osborne 3 can run much of the popular software. The operating system is Microsoft's MS-DOS Version 2.11, which can handle such programs as Lotus 1-2-3, Symphony, dBase II, WordStar and Multiplan. For the typical business this will be more than enough to get started. The machine will also run a number of languages such as Pascal and BASIC, but it cannot really be considered as a program development tool.

The machine's specific software is contained in ROM. The ROM is at present 64K, and on our machine not all the required software could be made to fit. We are informed there will be an upgrade soon that will supply the extra functions, such as communications.

The current ROM offering is the calculator and the clock, both of which can be used at any time during the operation of another program. You can break out of a spreadsheet, for example, and use the calculator to do a quick sum. The calculator only takes up a third of the screen and you can see the spread-

## SPECIFICATIONS

Unit:	Osborne 3
Made by:	Osborne Computer Corp.
Processor:	80C86 16-bit
Speed:	3.5 MHz
Display:	16 by 80 characters; 480 by 128 pixels addressable
Storage:	360K floppy disk drive (optional)
Ports:	RS-232C serial, Centronics parallel
Operating system:	MS/DOS 2.11
Weight:	4.4 kilos
Dimensions:	9.5 mm high by 13 mm wide by 5.5 mm deep
Options:	Extra drive, upgrade to 256K or 512K RAM, modem, battery.
Price:	128K with one disk drive: \$3431 (incl. tax); 128K with two drives: \$3792 (incl. tax); 256K with two drives: \$4189 (incl. tax); 512K with two drives: \$5297 (incl. tax)
Distributor:	Osborne Sales Centre (Aust), 3rd Floor, 93 York St, Sydney 2000. (02) 290 1122.

sheet below it, which means you can pick out displayed figures in the spreadsheet and work on them. The calculator can also be moved from one side of the screen to the other if necessary using a function key.

The clock takes up the whole screen and displays the time, a map of the world and a calendar. You can use the map to manipulate a time zone indicator to find out the time anywhere in the world. As you press a function key you move the time zone left or right and the time display changes accordingly.

### Bells and Whistles

As all good portables should, the Osborne 3 comes with an optional battery to permit operation when mains power is not available. This is a normal VCR-type battery that gives around five hours of operation, depending on the amount of computation involved.

You appreciate the quality of the design in the Osborne 3 when you consider the number of space-gobbling items that are squeezed into the tiny box. Just the battery and the twin disk drives leave very little space for anything else, yet there is a whole computer in there, plus a modem and serial and parallel ports. A lot of clever tricks must have gone into shoehorning it all in.

The documentation for the Osborne 3 is contained in the Osborne 3 MS-DOS User's Guide and the Osborne 3 User's Guide. These manuals adequately cover all aspects of the machine's use clearly and logically.

Most of the portable machines on the market these days are not

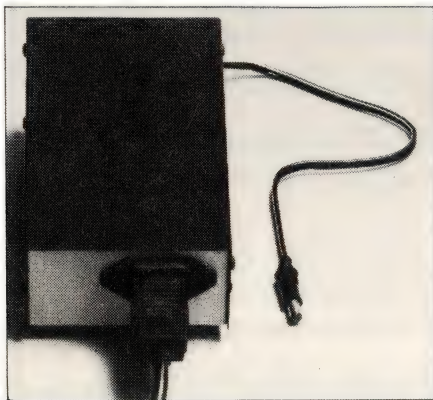

The Osborne comes with an external power supply.

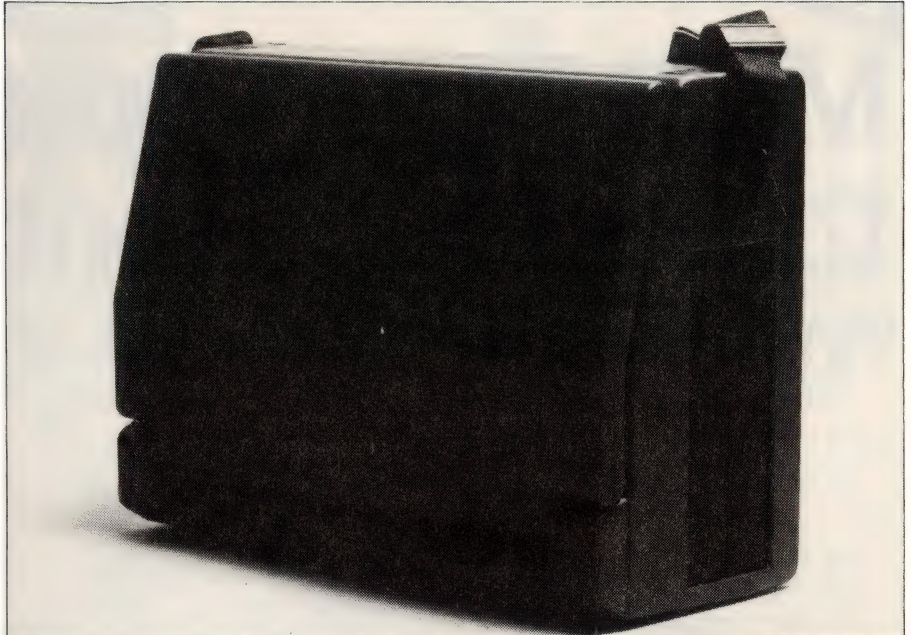

The Osborne is a true portable – impressively and compactly designed.

supplied with a carry handle. The carry handle on the Osborne 3 certainly demonstrates the reason they are not popular: they get in the way and make the computer look unsightly when being used. However, the Osborne 3 comes up with a solution; its carry strap clips to the sides of the machine for transportation and easily unclips when not needed.

### Marketing

The Osborne 3 should find a quite healthy niche for itself in the market. Its IBM compatibility seems quite high, and perhaps more importantly its price/performance ratio appears to make it one of the best buys for the Australian market. It will compare well with machines like the HP 110, but has an entry point considerably lower than the HP's. Its extra features, notably the disk drive, also give it a lot more flexibility than the HP.

In the United States the announcement of the Data General/One and its first shipments suggest the competition may get stiffer. The Data General/One (examined elsewhere in this issue) offers greater screen size, which may give it the edge over the 80 by 16 Osborne. The 25-line upgrade may balance this aspect out.

The Australian market is likely to be large companies which already

have computers but require portables for executives who want to take work home or salesmen and others who want to work in the field. Perhaps with this in mind, there is no plan to bundle software with the machine, as most purchasers will already have it. Nevertheless, it will be possible to buy various packages separately.

Osborne Computer Corporation's name is so closely associated with portable computing that it seems only right it should be a part of this new generation of go-anywhere machines, even if this one isn't its own design.

The Osborne 3 was in fact designed by Vadem/Studio Red, and has been supplied to both Osborne and to Morrow Designs. We saw the prototype at George Morrow's cocktail party during the 1983 Comdex exhibition, and were stunned by its clever design.

Morrow has announced the machine as the Pivot, but is modifying it internally before commencing shipments. Meanwhile, Osborne is the place to go if you want considerable computing power and on-line storage in a remarkably lightweight and compact package. For comfort and ease of use it must be close to top of the line, and its compatibility promises to make it a winner in IBM-orientated businesses. □

# SIEMENS

# Make sure you specify this super silent printer

Anything else is just a lot of noise



**IBM<sup>®</sup> PC  
COMPATIBLE  
SUPPORTS  
LOTUS 123\***

Before you finally decide on your computer, make sure your first add-on will be a printer that is reliable, versatile and quiet. Siemens PT88 and PT89 can be interfaced with most computer systems. Look for these peak performance features.

- Full EPSON<sup>®</sup> compatibility
- 80 or 132 column
- Variable character pitch
- High speed (150 cps) printing
- Tractor and friction feed
- Full graphics capability
- Consistent print quality
- High duty cycle

Siemens PT88 and PT89 Ink-Jet Printers put it all together with one compact, super

silent unit. You'll appreciate the long term value and a quietly efficient working environment.

Distributed Australia wide by:  
**BDS Computer Australia Pty. Ltd.**  
Melbourne: (03) 690 1222  
Sydney: (02) 437 4122  
Brisbane: (07) 353 3090  
Adelaide: (08) 79 9211  
Perth: (09) 322 1206

**BDS Dealers**  
ACI Computer Services (03) 543 6166  
Insystems Pty. Ltd. (03) 690 2899  
Hisoft Aust. Pty. Ltd. (03) 529 2333

**Siemens Ltd.**  
Melbourne, Sydney, Brisbane, Perth

## Send now for Free Booklet

To BDS, 145 Sturt Street,  
South Melbourne, Vic. 3205

Please forward your informative free booklet on "All you ever wanted to know about printer systems . . . now the facts."

Name .....

Position .....

Company .....

Address .....

.....

.....

698/1192

# Quietly impressive printers from Siemens

\* IBM is a registered trademark of International Business Machines Corp. \* 123 and Lotus are trademarks of Lotus Development Corp. \* EPSON is a registered trademark of EPSON America, Inc.

# NOW!

is the best time to subscribe to

# your computer

MAGAZINE

FOR BUSINESS AND PLEASURE

**FREE NASHUA  
DISKETTE OFFER**

**You'll not only save more than EIGHT DOLLARS on the regular news-stand price, but you'll also receive a FREE pack of TWO premium-grade NASHUA floppy diskettes, worth over \$8.50!**

Subscribing to **YOUR COMPUTER** will ensure that you get your copy of Australia's leading computer magazine reliably every month.

It's more convenient, too — your copy will come straight to your mailbox, saving you a special trip to pick one up. And, of course, if you subscribe at the moment, you'll be saving over eight dollars

on the regular news-stand price!

So **NOW** really is the time to send in your subscription — do it today, make sure you get your free discs as well! Simply fill in the card opposite and send it either with a cheque or money order, or with your American Express or Bankcard number filled in. Either way, don't forget to sign it!

**FREE** with every **SUBSCRIPTION**

**This pack of TWO double-sided, double-density top quality Professional Magnetic Media diskettes, from NASHUA, worth**

**over \$8.50!**

Double-sided, double-density (MD2D) diskettes are suitable for use in virtually any modern computer taking 5¼-inch diskettes. It doesn't matter if your computer has only single-sided drives — they'll still work fine, although only as single-sided disks.

**NASHUA** Professional Magnetic Media disks are of exceptionally high quality (we wouldn't be

selling them in our special offer if they weren't). Don't risk your valuable data by using inferior disks. **NASHUA** strictly monitor the quality of their disks at every stage of production — they don't rely solely on a final inspection like other disk makers. Every disk has to stay within narrow specs all the way along the line. So **NASHUA** disks offer you consistently high quality.

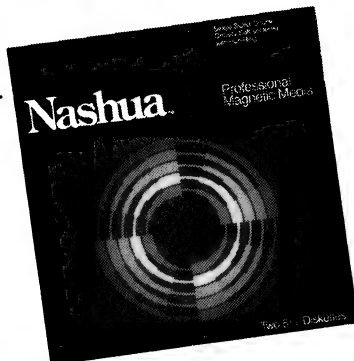

**What do you do when you've filled your two free diskettes?**

You can then take advantage of our special offer on boxes of 10 **NASHUA** diskettes — see the separate advertisement elsewhere in this issue.

*The race is on to be the first company to release a portable that's both small and powerful enough to act as a user's only computer. Rose Vines examines the recently released Data General/One, which could be one step nearer to the crown than any competitors so far.*

# DATA GENERAL/ONE

NOT SO LONG ago, portable computers were being produced as adjuncts to the office computer, a neat way of taking work home or on a trip, but definitely not designed to replace the general business workhorse. The big trade-off has been between power and size, with compact, high-quality machines such as the Hewlett-Packard 110 dispensing with built-in disk drives in order to qualify as truly portable.

This year looks like being the year when the portable becomes a true rival of desktop computers, and the Data General/One will be a leading contender. Only recently released in Australia, the Data General/One is a fully functional, truly portable computer.

The basic model has one 9 cm (720K) disk drive, a full 19 by 26 cm bit-mapped liquid crystal display (LCD) screen with 25 lines of 80 characters, 128K RAM, two asynchronous ports and an IBM-compatible bus extension. All this is packed into a 35 by 30 by 7 cm package weighing in at four kilograms.

The system can be expanded to include a second 9 cm drive, 512K RAM, an in-built 300 baud modem (so far this is Bell standard only, not Australia's CCITT standard) or external 1200 baud modem, battery pack and charger, which lets you run the system for about eight hours, an expansion chassis for IBM-compatible boards or additional storage devices, and a 13 cm stand-alone floppy which makes it easy to use standard software designed for the IBM PC.

## **Innovative Technology**

Data General has had to come up

with a few technical tricks to make its machine possible. The LCD screen is more than twice the size of other LCDs, and it took some persuading to get Hitachi and then Epson to attempt to produce such a screen. To overcome the problem of ghost images common to LCDs, DG divided the physically large panel into a number of smaller electrical panels, simultaneously driven. This helped to eliminate ghosts, but made functions such as smooth scrolling difficult to handle. A lot of time had to be devoted to developing the appropriate video display drivers to handle such tasks.

Another innovation is the extensive use made of CMOS (complementary metal-oxide semiconductor) technology. The Data General/One is built around the 80C88, the CMOS version of the 8088, which is used in the IBM PC. It runs at a slightly slower speed than the 8088 (4MHz for the 80C88, 4.77MHz for the 8088), but uses less power, a real plus for a portable. The designers have also chosen 64K static CMOS RAM chips for the memory. Apart from a reduction in power consumption, the CMOS elements produce almost no heat, allowing compact design without the need for heat dissipation techniques.

## **IBM Compatibility**

The Data General/One will run most IBM PC software designed around the documented IBM DOS and BIOS. The add-on 13 cm floppy disk is needed to read most IBM software, although some companies have already started producing their software on the 9 cm microfloppy format. So far, Lotus 1-2-3, Symphony,

WordStar and dBase II are available.

Some fairly rudimentary applications programs, such as a scratch-pad and terminal emulation for Data General minicomputers, are stored in ROM, along with a system configurator for setting up the Data General/One with a variety of monitors, keyboards and printers.

A lightweight printer has also been released to accompany the Data General/One. Weighing 1.8 kg, it prints 40 cps (characters per second) in draft mode and 20 cps in near-letter-quality. Although a thermal printer, it can use either smooth sheets or thermal paper, and runs on either the system's power supply or on its own nickel-cadmium batteries.

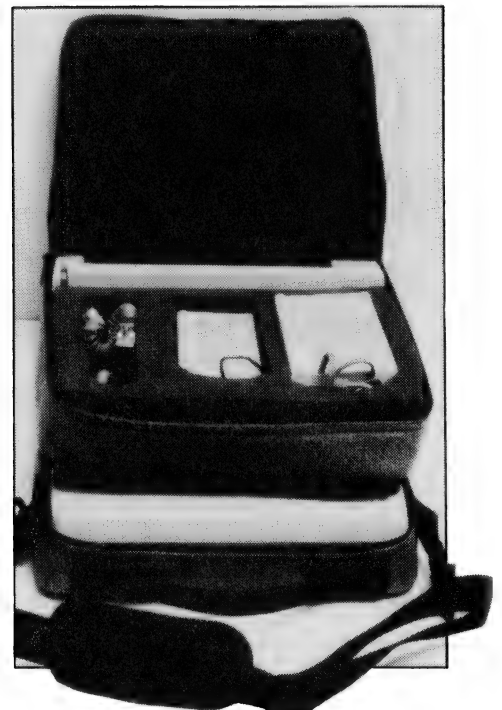



**Right: The Data General/One in all its full-screen splendour.**

**Below left: This carrying case is a necessary 'option' – the DG/One lacks a handle.**

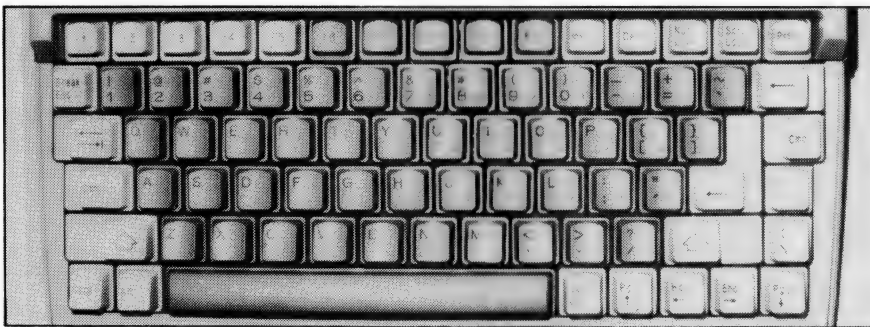

**Left: The keyboard combines IBM and Data General features.**

**Below: Sample printout from the DG/One Portable Printer.**

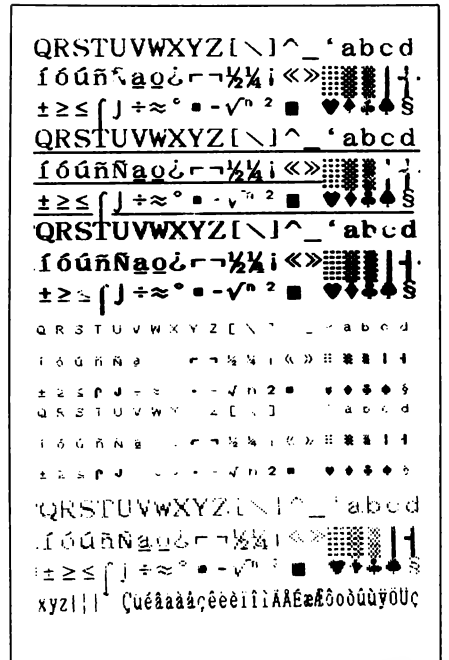

### Bottom Line

Not everything is wonderful with the Data General/One. LCDs are not much fun to work with for any length of time, even in ideal light conditions. However, the expansion chassis will permit connection to a normal display screen, which will overcome the problem when the machine is used for long periods.

The keyboard makes a few changes to the IBM standard, providing a degree of compatibility with both IBM and Data General computers. This will only prove a problem to those who have adapted to the idiosyncrasies of the IBM standard, and in most

respects reflects a positive step in keyboard layout.

The real problem for most people will be the price tag. The Data General/One will start at about \$5000 for the basic model, climbing to \$8000 for the fancier rigs. Certainly not a cheap machine, but if its everyday performance matches its specifications, it is quite likely to prove the only computer you'll need (watch out for a more in-depth review of the DG/One once we've had a chance to get our hands on one of them for a few days). Gone are the days of the 'portable' playing second fiddle. □

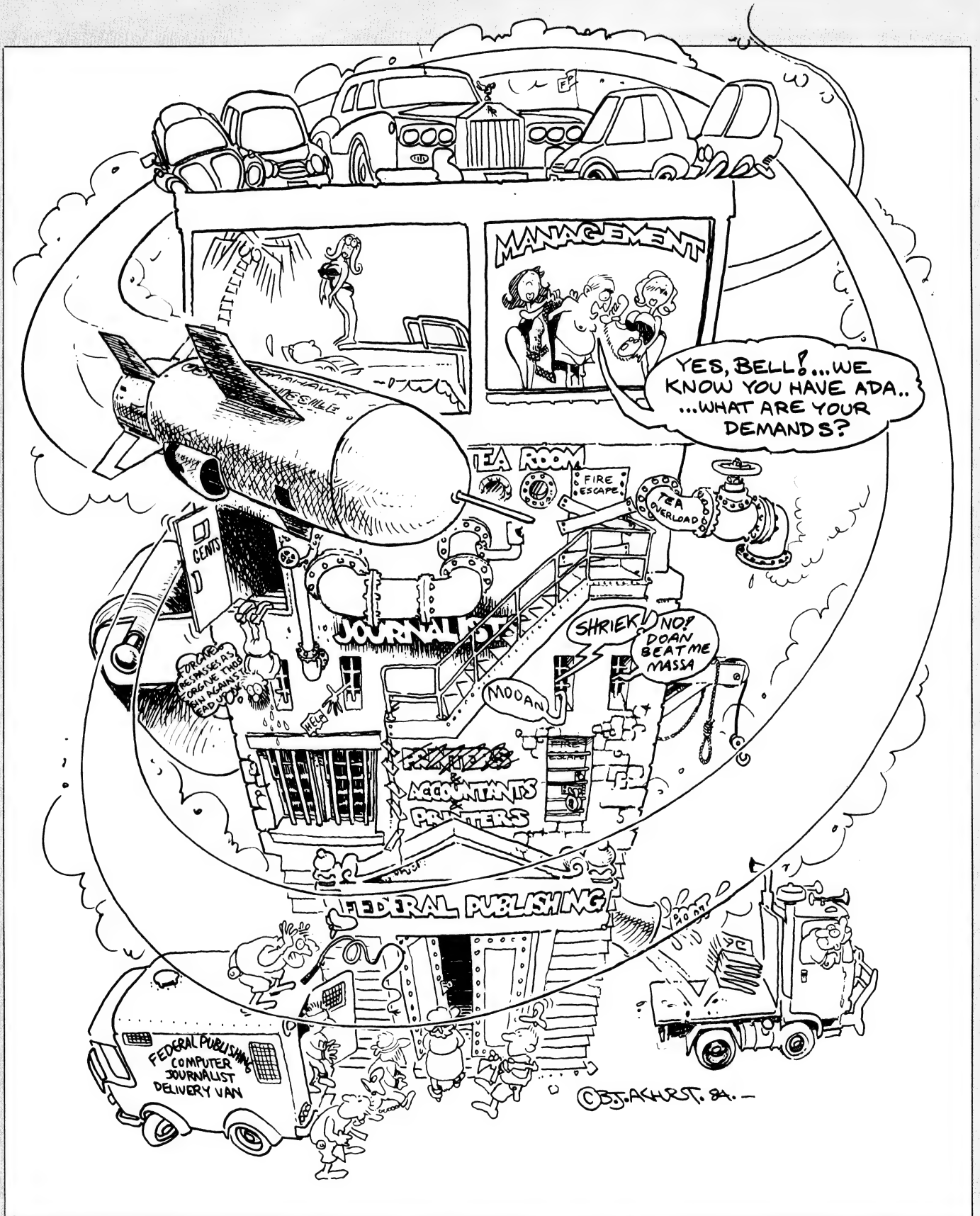

*Cunning computer linguist Les Bell is always eager to add another language to his collection. That's why he was particularly pleased to review Ada, a language developed by the US Department of Defense, and Janus, a subset of that language.*

# Defend Yourself with JANUS ADA

BACK IN the late fifties, there was great concern at the US Department of Defence about the number of computer languages in use there. You see, every computer manufacturer had his own language, although it would more properly be called a code.

Consequently, a team was assembled to develop a new computer language which could run on all kinds of computers, and which would be suitable for the applications DoD was involved in – giant personnel, payroll and inventory problems.

The result was COBOL (Commercial

and Business Oriented Language). It was purely commercially oriented because that was the major application area at DoD, since computers were not yet in use for navigation, missile control and the other new-fangled things we take for granted today.

COBOL solved the immediate problem, and because of the DoD's use of contractors, soon found its way into the real world to become the dominant language for commercial programming, a position it still holds today.

However, back at DoD, computers now *are* being used for navigation and so on. What's more, they're being programmed in all kinds of languages, with accompanying problems of performance, reliability, maintenance and the like. In other words, the problem has surfaced again.

Fortunately, DoD saw it coming, and in the late seventies it started taking steps to design a new standard language which would be suitable for

## SOFTWARE REPORT CARD

Program:	Janus/Ada compiler and utilities			
Made by:	RR Software			
Useful for:	Programming in Ada			
Hardware required:	8080/Z-80/8086/8088 under CP/M, CP/M-86 or MS-DOS			
<b>Ratings:</b>	<b>Excellent</b>	<b>Very Good</b>	<b>Good</b>	<b>Poor</b>
Documentation:		•		
Ease of use:			•	
Speed:	•			
Functionality:		•		
Support:		•		
Value-for-money:		•		
Extras included:	Pastran Pascal-to-Ada translator, Optimiser			
Options:	Profiler			
Price:	MS-DOS/CP/M-86 Development Pack (D-Pack) version: \$795 incl. tax; CP/M-80 version: \$566 incl. tax			
Review Copy from:	Ada Australia, 11 Blackmore Street, Windsor 4030. (07) 57 6999.			

```

package fileio is

  type status is (ok, fail);
  type mode is (read, write);
  procedure open (filename : in string; filemode : in mode; filestat : out status);
  procedure get (filename : in string; stuff : out string);
  procedure put (filename: in string; stuff : out string; filestat : out status);
  procedure close (filename: in string);

end fileio;

```

**Listing 1.**

```

package body myprog is

  myfile : string;
  line : string;
  -- etc.

begin

  fileio.open(myfile,read,stat);

  if stat /= ok then -- do something about it ;

  fileio.get(myfile,line)
  while line /= "END" loop
    fileio.get(myfile,line);
  -- Do something with this line of data
  end loop;

  fileio.close(myfile);

end myprog;

```

**Listing 2.**

```

package body myprog is

  myfile : string;
  line : string;
  -- etc.

with fileio; use fileio;

begin

  open(myfile,read,stat);

  if stat /= ok then -- do something about it ;

  get(myfile,line)
  while line /= "END" loop
    get(myfile,line);
  -- Do something with this line of data
  end loop;

  close(myfile);

end myprog;

```

**Listing 3.**

```

function sqrt(x : x float) is
  -- body of floating point square root function
function sqrt(x : x integer) is
  -- body of integer square root function
floatvar : float;
intvar : integer
begin
  floatvar := sqrt(floatvar); -- calls floating sqrt function
  intvar := sqrt(intvar); -- calls integer sqrt function

```

**Listing 4.**

these applications. The language had to be powerful and sophisticated yet simple and maintainable, and should incorporate the latest concepts of structured programming.

The DoD High Order Language Working Group created a specification for the new language, requiring it to be based on one of three base languages: Pascal, Algol 68 or PL/I.

**Ada – the Language**

Several teams set out to create such a language, but the successful team, from Cii Honeywell-Bull, in France, based its proposal on Pascal, and experienced Pascal users will recognise the flavour. Although designed by a team, Ada does not suffer from the usual problems of committee-originated products, since one man, Jean Ichbiah, accepted responsibility for the overall design.

Ada actually addresses a number of problems which have emerged as recent issues in software engineering. For example, we now know that the cost of software is significantly higher than that of hardware. We know that the cost of fixing bugs increases rapidly the later they are discovered, and that the cost of maintaining a program is high in comparison with the original cost of writing it.

One key feature of software developed by or for the DoD is its complexity and size; we are talking here about projects at least in the tens, if not hundreds, of man-years in development. In this environment, it is essential that code once developed be re-used, and that developers are able to create a library of routines with a well-defined interface.

Ada addresses this requirement with the concept of the package. A package comprises two parts: a specification part and an implementation part (users of UCSD and Apple Pascal will be familiar with this).

The specification part, which can be a separate file, consists purely of declarations, usually of the parameters which are passed to or from the procedures in the package.

The implementation part, or package body, contains the procedures or functions which work on the parameters named in the specification. It may also contain declarations, but only of local variables. Incidentally, the specification can also declare variables

and types which are not accessible from outside the package, in what is called the private part of the specification.

Packages may be separately compiled and then linked together. The private part of the package specification, and the package body itself, hide information from the user. Thus, given a package called quicksort, the user has to take it on faith that this is a quicksort routine, and cannot tinker with the innards of the routine to convert it or otherwise abuse it. More to the point, it forces the original author of the quicksort package to make it as general as possible and to think hard about its interface with other routines.

The programmer can refer to variables in other packages by their names prefixed by the name of the package. Take a look at the code segment in Listing 1; this is the package specification for some file handling code which can read and write sequential files. To actually use these routines in an Ada program, a programmer would write the code shown in Listing 2 (by the way, Ada comments are written as '-- comment'), or some similar code. Notice that, because the file access routines (open, get, put and close) are defined in the package fileio, they are prefixed by that name in this package. An alternative shorthand, shown in Listing 3, can be used.

A common problem with languages which permit independent compilation of modules is that it is possible to modify one module without updating another, related, module. Subsequent recompilation will lead to disaster. We know, we've done it with Pascal, PL/I and other languages.

In a full Ada system – what is called the Ada Programming Support Environment – the compiler maintains a database of the packages and their relationships or logical dependencies. So that if one module – B – depends on another – A – and A is modified, the compiler will refuse to recompile B until A has been recompiled. Any other packages which depend upon B will also fail to recompile.

Not only this, but if one package is modified, the compiler will recompile and link only those packages which are dependent on the modified one, thus cutting down on compile time.

```

Package Body guess Is

  Number,Guess : Integer;
  Name : Array (1..30) of Character;
  Play : Character;
  Gen : Float;
  Root : constant := 0.211327;

  Procedure Random (n : In Out Integer) Is
    Temp : Float;

  Begin
    Temp := 9821 * Gen + Root;
    Gen := Temp - Integer(Temp);
    n := Integer(100 * Gen);
  End Random;

Begin
  Gen := Root;
  New_line;
  Put("Hi, there, what is your name ? ");
  Get(Name); Skip_line;
  Put("OK "); Put(Name); New_line;
  Put("Do you want to play a guessing game ? ");
  Get(Play); Skip_line;
  While (Play = "Y") Or (Play = "y") Loop
    New_line;
    Random(Number);
    Put("I am thinking of a number between 1 and 100"); New_line;
    Put("What is your guess ? ");
    Get(Guess); Skip_line;
    While Guess /= Number Loop
      If Guess > Number Then
        Put("Too high"); New_line;
      Else
        Put("Too low"); New_line;
      End If;
      Put("What is your guess ? ");
      Get(Guess); Skip_line;
    End Loop;
    Put("You got it , "); Put(Name); New_line;
    Put("Do you want to play again ? ");
    Get(Play); Skip_line;
  End Loop;
  Put("Good Bye, "); Put(Name); New_line;
End guess;

```

**The guessing game (see *Your Computer*, January 1985, 'Computerspeak') written in Janus/Ada.**

This automates the functions that are performed by the UNIX source code control system, or on a smaller scale, my compiler manager (see 'Programmer's Workbench', *YC*, September 1984).

All these features are designed to make programs written in Ada easy to write and to modify or maintain – especially the latter. They also help to ensure that Ada programs are bug-free – an important consideration when writing software that will, for example, guide cruise missiles.

### Overloading

Ada supports a facility known as overloading, which can be very useful

when writing libraries of generalised routines. For example, suppose you have been given the task of writing a suite of mathematical functions for your company, such as square root and others.

Now on occasions you may want to take the square root of a floating point number, and on other occasions you may want to take the square root of an integer. In most languages, you would resolve this by writing two square root routines, called fsqrt and isqrt, and warning all programmers to use the right one.

Ada is able to distinguish between two identically named routines on the basis of the types, number and

# NEW YEAR OFFERS!!

## OFFER #1:

### BI-XT-88 16 Bit Computer

The **ULTIMATE** Personal Computer that gives you **IBM™ PC/XT compatibility at a fraction of the cost.**

**PC 88 COMPLETE SYSTEM \$3500.00\***

- (a) 256K RAM memory with twin floppy DSDD disk drives. 16 bit 8088 CPU with interrupt control (8259) and direct access controller (8237). Colour graphic card multifunction card. Disk drive card and mainboard & keyboard 100 watt fan.
- (b) TAXAN Colour vision III monitor — RGB.
- (c) **PLUS — FREE — 120 CPS dot matrix printer 'PX-120'**



COURIER SERVICE AVAILABLE  
Free delivery in Sydney Metropolitan area.  
\* 6 months warranty for parts and labour.

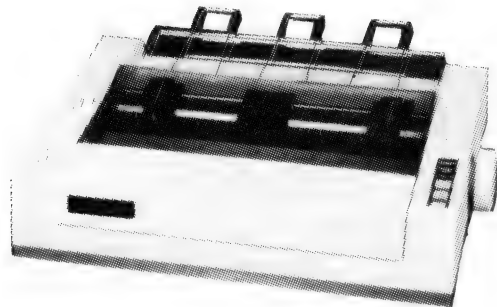

**OFFER #2: One Diskette box containing 10 x 5 1/4" DDSS diskettes. PLUS — One 50 Floppy diskette 5 1/4" Storage Box (plastic casing with diskette free) \$35.00\***  
*Certified and error free.*

**BI COMPUTER PTY. LTD.** (Incorp. in N.S.W.)

P.O. Box 896, Potts Point, 2011.

Suite 23 (2nd flr.), Minton House,

2A Bayswater Rd., Kings Cross, N.S.W. 2011.

Telephone: (02) 356-2388

\* Postage & handling extra  
\* WHILE STOCKS LAST!

Name: ..... OFFER 1: qty

I wish to pay by Bank Cheque ..... Bankcard.....

Company: ..... OFFER 2: qty

Card No ..... Expiry Date.....

Address:.....

..... Postcode:.....

Signature.....

Telephone ( ).....

Post & handling  Courier

OPTION: Computer Training Services available,  
Incl. Word Processing, Lotus 123 — CALL NOW FOR DETAILS.

**TRADE ENQUIRY  
WELCOME**

names of the parameters and the result type. Listing 4 is an example. The compiler automatically sorts out just which function has to be called in a particular case.

Ada boasts a number of other unusual features. For example, parameters can be passed to a procedure by means of 'keyword notation', which looks like this:

```
open (filename => 'FRED.DAT'
filemode => READ filestat =>mys-
tat);
```

Here it is obvious which parameters are being passed, and the order is not important.

Ada also supports multi-tasking programs which consist of multiple threads of execution that have to be synchronised, through the task declaration. It is even possible for the programmer to specify in what format variables are stored (allowing communication with programs written in other languages) and even force storage in specific processor registers if required.

All this adds up to a language that is complex, but which is powerful enough to tackle a range of problems, making it well worth the learning.

### Janus/Ada

Janus/Ada, from RR Software, gets its name from the fact that all Ada compilers must pass the official Ada Compiler Validation Suite. There are no subsets of Ada, and no extensions to the language. This assures full

```
package body bml is
  lower : constant := 1;
  upper : constant := 32767;
  midle : constant := 20;

  i : integer;
  j : integer;

begin
  i := lower;
  while i < midle loop
    j := lower;
    while j < upper loop
      j := j + 1;
    end loop;
    i := i + 1;
  end loop;

end bml;
```

Figure 1. bm1.pkg.

```
-- Eratosthenes Sieve Prime Number Generator Program in Ada
Pragma Rangecheck(off);
package body Sieve is
  Size : Constant := 8190;
  Flags : Array (0..Size) of Byte;
  True : Byte := Byte(1);
  False : Byte := Byte(0);
  Count : Integer;
  K : Integer;
  Prime : Integer;

begin
  put("10 Iterations");
  new line;
  for Iter in 1..10 loop
    Count := 0;
    for I in 0..Size loop
      Flags(I) := True;
    end loop;
    for I in 0..Size loop
      if Flags(I) = True then
        Prime := I + I + 3;
        K := I + Prime;
        while K <= Size loop
          Flags(K) := False;
          K := K + Prime;
        end loop;
        put(Prime);
        new line;
        Count := Count + 1;
      end if;
    end loop;
  end loop;
  put (Count);
  put (" primes.");
end Sieve;
```

The Sieve of Eratosthenes in Ada.

portability of Ada programs.

Janus is a subset of Ada, therefore it is not Ada. Despite this, it is a very full subset, which enables programmers to get a feel for the full language. Janus supports most Ada data types (integers, reals (with 8087), characters, enumerated types, Booleans, one-dimensional arrays and variant records) plus a few of its own: bytes and strings. Like Pascal, Ada allows the programmer to define his or her own types.

Janus also supports the separate compilation features of Ada, so that packages can be separately compiled and linked. Programmers who have worked on large projects (or what seemed large) will appreciate this capability.

Janus does not support several of the more complex Ada capabilities, such as tasking, exception handling and representation specifications (which describe how objects are stored). There are also some variations in the Janus pragmas (compiler switches) and other minor deviations

from the Ada standard, but these are not significant for most purposes. In any case, Janus has a pragma which will generate warning messages for any non-standard usages.

The Janus compiler is a large system (almost 400 kilobytes for the compiler alone). It's a multi-pass compiler, four passes plus the separate linker, but compiles about as fast as the PL/I compiler, which is the closest thing we have to it.

We found no bugs in the compiler or the code it generated, although we weren't really pushing it to the limits, so to speak. Since we were running under MP/M-86, we had to set some of the compatibility attributes on the compiler, suggesting that its file handling may be done in a non-standard way (at least as far as MP/M is concerned).

One thing the compiler does that can catch the unwary is that it reads the symbol tables files (.SYM) from previous compilations. If, as I was doing, you compile a program called SIEVE.PLI using the PL/I compiler,

## JANUS ADA

Straight compile	Rangecheck(off)	Optimiser	Both
39.90 s	18.04 s	34.22 s	12.47 s

**Figure 2.**

Rangecheck(off)	Rangecheck(off) and Optimised	PL/I-86
16.06	13.34	9.97

**Figure 3.**

then run the Janus compiler on SIEVE.PKG, the compiler will make no sense of the .SYM file the PL/I compiler has left behind, and will produce an error message. The answer is to erase any .SYM files before compiling.

The compiler's performance is pretty good, all things considered. We first of all ran a simple looping benchmark (Figure 1) and compared it against the DRI PL/I compiler, which is a pretty good performer. The results were as follows:

Janus/Ada: 39.90 seconds  
DRI PL/I-86: 12.47 seconds

This means that, doing simple binary arithmetic, the PL/I code was over three times faster. But! – there is a catch. Like Pascal, Ada normally inserts range and overflow checking, to produce error messages rather than simply crashing – which, of course, takes time. By using a pragma to disable range checking, we were able to speed the program up:

Janus/Ada: 18.04 seconds  
DRI PL/I-86: 12.47 seconds

The situation is improving.

Janus can optionally be supplied with a code optimiser which examines the generated code, removes code that is never executed and generally tightens up the code to improve performance. The result is a program that is smaller (so it loads faster) and executes faster. The results of using the optimiser are shown in Figure 2.

You can see that with optimisation and with range checking disabled, Janus/Ada provides the same performance as the PL/I compiler. The code generated by the Ada compiler is smaller than that for the PL/I compiler, reducing load time, so the

actual processor performance of the Janus code is probably very slightly less than that of PL/I.

One area where the PL/I code spends a lot of its time is in output formatting, since it right justifies numbers, while the Ada standard, like Pascal, is for left justification.

All this shows that while, at first glance, the Janus compiler generates adequate, if slightly slow, code, once you investigate the options it can be speeded up dramatically with no changes to the code. It ain't what you've got, it's how you use it.

We also tried the Janus and DRI PL/I compilers on the Sieve of Eratosthenes benchmark, with the results shown in Figure 3. Again, the code generated by the PL/I compiler was more than twice as big.

We did encounter one small bug in the optimiser – it generated a Divide By Zero Encountered error while optimising a very small program.

### Additional Features

As well as the optimiser, there are a couple of other options for Janus/Ada. One of the most immediately useful is a Pascal to Ada translator called Pastran. We tried this on a couple of small programs, with great success, although we didn't have any large Pascal programs around the office to give it a real test.

There is also a profiler utility which can be used to locate hot spots in programs and find out where the processor is spending most of its time. Use of a profiler program is mandatory before trying to improve the 'efficiency' of programs, as often your efforts to improve things make only very little difference.

### Documentation

The Janus/Ada package comes with

a quite comprehensive manual for the compiler and the other options, but it is in no way suitable for learning the Ada language, and a separate textbook will be required for this purpose. Fortunately, there are plenty of good textbooks around.

The Janus/Ada manual is well organised, and I found the information I needed in it without too much trouble. One small objection is that the cover is too floppy to hold it upright in a bookshelf – but many users will just leave it open on their desks anyway.

The Janus/Ada disks come with a variety of additional libraries for additional functions such as colour graphics or accessing a real-time clock (necessary for the profiler). For example, the NEC APC version has been modified to access that machine's hardware features.

Ada is, as many of its proponents rightly point out, the language of the nineties. Whether it will be able to knock C off its favoured position is open to debate, but it certainly will provide many programmers with their first taste of a really advanced software tool. And of course, since it is sponsored by DoD (those wonderful people who brought you COBOL), many programmers will simply have to work in it, whether they want to or not.

Janus/Ada is a very useful implementation of a subset of this important language. It is obviously of high quality and is usable for creation of finished products now. Anybody interested in getting a grasp on Ada is strongly recommended to investigate Janus/Ada.

```

package body bm2 is
    lower : constant := 1;
    upper : constant := 1000;

    i : integer;
    j : integer;

begin
    i := lower;
    while i < upper loop
        i := i + 1;
        put(i);
        new_line;
    end loop;

end bm2;

```

**Benchmark 2 in Ada.**



Privately, even the experts will tell you that dBASE is the number 1 database management system in the world.\* Now with dBASE III, you can get even more out of your IBM PC or close compatible. It's fast, it's easy.

**It's also very clever.** dBASE III copes equally with the needs of the novice and the demands of the expert. If you're unsure of a command, HELP will tell you what to ask for. If you don't know what command comes next — ask the database ASSISTANT. And experts can talk in code, just the way they're used to.

**dBASE is used** to handle your information. Doctors and lawyers. Accountants and salespeople. Big business and small. The routine and the unexpected.

**You've never seen anything like it.** dBASE III can handle over a billion records per file, and you can have up to ten files open. When you have two related files, information in one can be accessed based upon data in the other. dBASE III now handles procedures, parameter passing and automatic variables. dBASE III isn't just fast. It's ultra-fast, indexing and sorting.

**What about dBASE II?** If you have an 8-bit computer running CP/M, then dBASE II is still No.1.

## Expert or novice?

There's no hidden extras with dBASE III. You get a complete manual, tutorial and all the software. And top Australian support. Contact your local dealer, now, for a demonstration. Or use the coupon below to obtain more information from the Master Distributors, Arcom Pacific.

**arcompacific**  
 ■ master distributor ■

----- ✂

Please send me details about dBASE III  and other ARCOM PACIFIC products

My name is .....

Company name .....

Address .....

..... Postcode .....

The micro I currently use is .....

and software .....

Send to ARCOM PACIFIC Freepost 2 (no stamp required)  
 P.O. Box 13, Clayfield Qld. 4011

\* Over a quarter of a million copies of dBASE are in use throughout the world, more than any other business data base product.

† dBASE II and dBASE III are registered trademarks of Ashton-Tate. IBM is the registered trademark of International Business Machines.

# The educational computer that act

In this classroom, the teacher (master station) has access to every student (work station).

All students can share the one program (subject) and work on it at their own pace.

Or every student can work on an entirely different program.

So, one student can progress to a highly advanced level while the student next door happily tackles a more basic program.

(There is a vast array of educational programs designed for the system. And not just on computing, but right across the school curriculum.)



The BBC computer is the only computer in the world that was created specifically for education.

It works perfectly in a classroom because it was designed in a classroom.

And not just any classroom, but the computer sciences facility at Cambridge University.

And leading the team were the creators of some of the most outstanding educational television in the world.

None less than the British Broadcasting Corporation.

The BBC, along with Acorn Computers Pty. Ltd., developed the system for the British Government to implement a major educational policy, the Computer Literacy Program.

In doing so, they created a computer that could teach all computers a thing or two about capability, expandability and networking.

A computer which is now used in over 80% of British schools.

And on approximately 5,000 desks in Australian schools.



# ually works in a classroom situation.

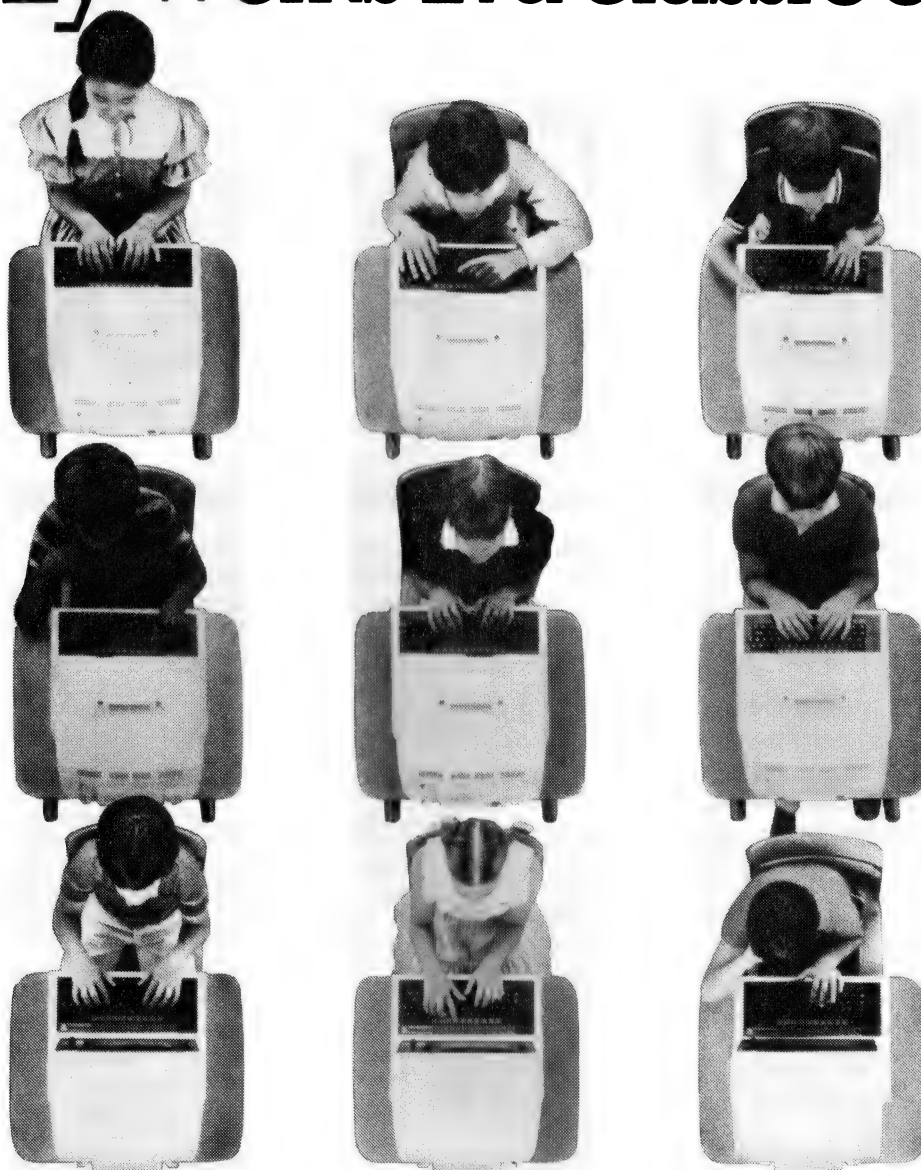

Just like a normal classroom, the teacher can "talk" to the entire class at once.

Or choose to "look in" on a particular student's work, with or without them knowing.

The teacher can then offer help, or take complete control of the student's screen.

The system also does the job of the old exercise book, storing all students' work for later review and grading by the teacher.

In all, it works just like a typical classroom.

Except that everyone in the classroom is learning how to use a computer.

A computer recommended by six State Education Departments in Australia.

The Computer Literacy Program also generated teacher training programs, a library of understandable computer literature, a vast range of quality educational software and a television series directed at schools.

All of which we have in Australia, now.

Together with the computer the BBC proudly put their name to. The BBC.

The BBC Microcomputer is brought to Australia by Barson Computers, Australia's leading independent computer company.

Barson also provide all the software, service and technical back-up you may require.

For more information, post this coupon to:  
Barson Computers Pty. Ltd.,  
335 Johnston Street,  
Abbotsford, Victoria 3067.  
Or phone Barson Melbourne on (03)4193033 or Sydney on (02)9572588.

## The BBC.

Name: .....

School or College: .....

.....

Address: .....

.....

..... Postcode: .....

**BARSON COMPUTERS**

# WANG DIVES INTO IBM's POOL

WANG'S POSITION in the computer market has been gained through an indisputably superior product for the clustered word processing market. The Boston-based company boasts a 73 per cent share of the installed base of clustered word processing in Australia. In the first quarter of the fiscal year 1984-85, Wang Australia posted sales of \$27 million, a 107 per cent increase on the year before.

Wang has been aware, though, that a large market is waiting to get into word processing but cannot afford a high-powered system. With the Wang Office Assistant, Wang hopes to capture a large piece of a market that could represent up to one million secretaries and clerks. The Wang Office Assistant offers an impressive package; it costs less than \$4000, just above top-of-the-range typewriters, but it has the power and flexibility of a full-featured word processor.

The new system consists of a monitor, 256 Kbytes of RAM, an 80186 16-bit processor and one 360K floppy disk drive. On the software side is Wang WP Plus, forms processing, typewriter functions, Multiplan spreadsheet and system utilities. The system is also integrated with the rest of the Wang equipment hierarchy. A key feature of the system is multi-tasking, which lets the user access up to six tasks (depending on memory size).

The marketing of the new product is to be aimed mainly at the secretary, although the system will also have a market among clerical staff. US advertising has, so far, aimed squarely at the secretary, with spots being taken in magazines like

*Harpers*, and during television programmes like 'Dynasty'.

The new system will be marketed in Australia largely through Wang's dealer network, with Wang offices servicing major accounts such as government departments and large companies.

## Getting Started

Training on the new machine takes a number of forms. There is a self-training package that comes with the system or you can buy an on-line tutorial package that takes you through all the system's features. Wang also offers short courses in word processing.

Dealers will be responsible for the support of the systems, and users with maintenance contracts will be able to use Wang's Action Centres to phone in and get technical and operational assistance.

According to Julie Pearson, Senior Marketing Executive with Wang, it will take the average person about two days to get to know all the features of the system and about a week to be able to use them with confidence. The basic functions – opening a document, typing in text, editing and saving – can be learned in about an hour. Julie also points out that there is a large pool of trained Wang operators in the marketplace who are already competent in the operation of Wang word processors.

## Hands On

On a recent visit from the Boston Head Office, Wang representative Amy Porter demonstrated some of the system's features.

When you turn the system on, software in programmable read only memory (PROM) goes through power-up diagnostic routines to check that the system is fully operational. When these are completed you are presented with a date and time menu and then either the main system menu or an auto load program, such as word processing. Across the top of the screen a status line will appear which shows you all the utilities currently loaded into memory. This is a ready reminder of the programs you can flip to, without loading, using the multi-tasking feature.

## Forms Processing

While word processing is the *raison d'être* for the Wang Office Assistant, the forms processor is one of the most spectacular utilities. Most people regard this type of job as a lot easier with a typewriter than a normal word processor, as a typewriter can be manoeuvred by hand.

In a sense, this is what the forms processing software does. To set up a form, you put it in the printer and line up a specific point under the printhead. A standard reference point is vital in this process and Wang recommends setting the printhead to the beginning of the first field on the form with the margin hard against the edge of the printer or with a two-inch offset (the printer uses imperial measurement).

Working from this point you can then tell the computer "this is the start of a field" and then move the printhead to the end of the field. Here, you tell the computer "you are at the end of the field" and then

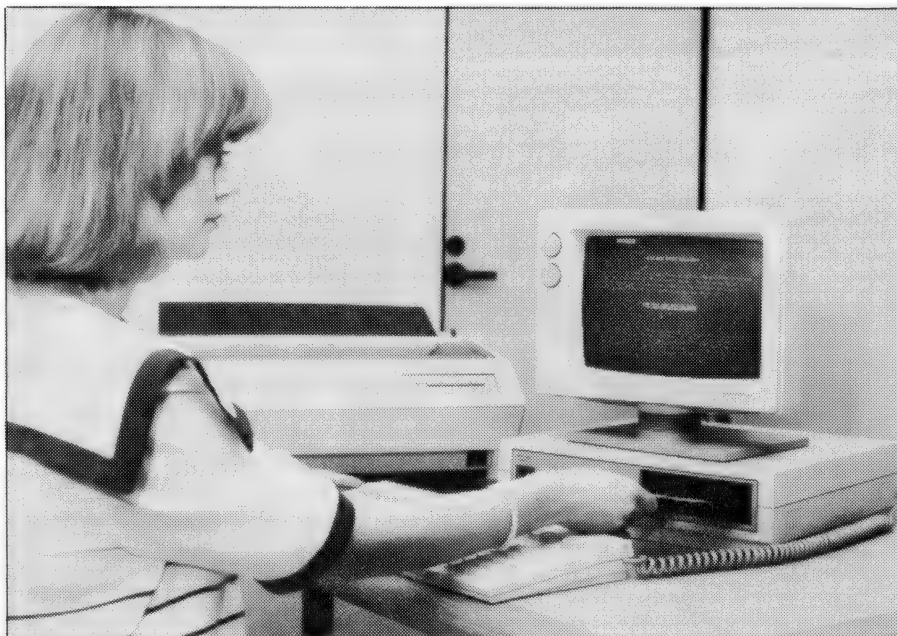

move to the next field and repeat the process. As you do this the computer displays the fields as underlining on the screen. The printhead can be moved by small increments horizontally and vertically, so you can print anywhere on the sheet of paper. The printhead is controlled using the arrow keys on the keyboard.

Once you have run the printer over all the required fields you have set up the format of the form. This can be edited if necessary or you can move to the next phase of the form set-up process, labelling the fields.

When you label a field on the screen you can actually move the field if you need more space for the label, without affecting the position of the field on the printer. You can also specify protected fields such as alphabetic characters, numeric or date format. You can specify various styles of type for each field, such as bold and italic, subscripted and superscripted. When you have completed the form layout the input stage is simply a matter of filling in the blanks, moving to the next field when you hit return and then saving each form. When you merge-print the forms you can choose to print all the

*'The ball game is over,' say Wang's marketing moguls. According to Wang, the age of the golfball typewriter has come to an end with the release of the Wang Office Assistant, a computer and software package that brings full-featured word processing to the mass market. Evan McHugh checked out the claims.*

entries for the form or just selected entries.

### Typewriting

Another utility that makes use of the ability to manipulate the printer directly is the Typewriter function. With this, you open a direct link to the printer that lets you type straight onto a sheet of paper. This means you can do a quick letter or envelope just like you would with a normal typewriter.

There is one difference, though, in that you can operate in two modes. One is the direct mode, just described, the other is shadow mode. Shadow mode prints line by line, whenever you hit return. You can type a line and edit any mistakes in it before printing. All very well, but it's not what the system is really all about, which is ...

### Word Processing

Wang practically invented word processing. The word processor on this system is a version of Wang WP Plus. It is no longer possible to describe word processors like WP Plus as full-featured because each new edition offers so much more than its predecessors. Full implies an

upper limit but Wang is constantly extending the functionality and usability of its software so it can keep its place on top of the WP heap.

This latest package has format lines only on the top of the screen, as opposed to previous packages where format lines appeared in text. Instead of the format line there is now a small cursor to indicate a change of format. When you move below this cursor the format line at the top of the screen will change to reflect the new format that you have entered.

When scrolling, the next ten lines are displayed, so you can see not just where you are going, but a lot of where you have been as well. To delete text, you hold down the delete key and then press arrows to go in any direction while deleting. Whatever you are about to delete is displayed in bold text. If you have text that is right justified rejustifying will occur, automatically, after a deletion. While in insert mode you can delete, copy, move and replace text.

Hard and soft page breaks can be put into copy. If you want to start a new page, say, for a new chapter of a book, you can use the hard page

#### Table of prices

Basic machine	\$3880
20 cps printer	\$1950
55 cps printer	\$4500
Extra disk drive	\$650
VS Emulation	\$910
Printer sharer	\$800

Computer and printer package \$300 less than separate items

## COMMENT

break to do so. When you add new text that changes the number of lines in a page, the soft page breaks will be adjusted as necessary. During adjustments, footnotes are moved or preserved as necessary. The page-breaking software also knows about widows and orphans, which are terms describing the conventions that say, respectively, you shouldn't end a paragraph on the first line of a column or start a paragraph on the last line of a page.

One special feature of the package is the ability to specify up to twelve columns. Word-wrapping takes place within each column without disturbance to any other columns. You can change styles and formats within columns as well.

Legal secretaries can make use of the strikeout feature. When something is struck from a legal document the text must be left in with lines through it. Many word processors will not display text or print it with slashes through the characters. Strikeout on

the Wang system does just that, with support for the same facility on the printer.

The final feature of this version of WP Plus is Supercopy. This displays two documents on a split screen and dynamically copies from one to the other, or vice versa.

### Sundry Functions

Within the maintenance utility, apart from specifying date formats, system names and auto load files, you can also decide which keys you want to be able to repeat and the type of printer you want to use. Wang is checking out printers that will work with the Office Assistant; however, the way in which the software operates the printer may mean that many printers will lose the full functionality available with Wang's own printers. Wang has two printers available with this system, both letter-quality printers, operating at 20 and 55 characters per second. Two other printers are recommended by Wang, the Qume Sprint 11 and the Olympia Standard typewriter, which can be interfaced to a computer.

There is a facility that lets you keep a scratchpad of things to do. Various extensions to the system are available, including teletype communi-

cation and Wang VS emulation. There is also an upgrade that will let you connect up to four Office Assistants to one printer.

The basic system price is around \$3880, and the machines will be available off the shelf. For this price you get all the software mentioned, an 800 by 300 non-glare green monitor, floppy disk drive and computer with 256 Kbytes of RAM. RAM can be upgraded to 512K. The keyboard is detachable, low-profile, with word processing keys, and numeric keypad.

The 13 cm floppy disk drive holds 360K and is the only real source of annoyance with an otherwise good system. You can get an add-on disk drive, although the ideal option would be a hard disk, which does not seem likely at this stage.

In Wang's opinion, the age of the golfball typewriter is dead. The machine it would like to usher in the new age of word processing offers a low entry point to very powerful word processing, from a company with an excellent reputation in the field, combined with a spreadsheet, excellent forms processor and a powerful microprocessor. What you get, and the price you get it at, may threaten more than some companies' golf balls. □

## EMONA HAS MOVED!!

GOULBURN ST.

HAYMARKET  
GEORGE ST.



CAMPBELL ST.

Our new address is  
1st Floor, 720 George St.,  
SYDNEY  
(above Mick Simmons Sports Store)  
**COME TO OUR NEW SHOWROOM  
AND SAVE \$\$\$ ON OUR  
OPENING SPECIALS**

## MicroProfessor MPF-III

### STANDARD FEATURES

- Runs 8 languages • Upper & lower case
- Detachable keyboard with 90 keys
- 40/80 column (keyboard selectable)
- Centronics printer interface
- 36 tone sound generation chip
- Powerful editing features
- 4 additional expansion slots
- One key basic command entry
- 12 programmable function keys
- Numeric key pad
- RF Modulator • Cassette interface
- High & low resolution colour graphics
- 64K RAM, 24K ROM
- Comprehensive operation manual
- Pal colour

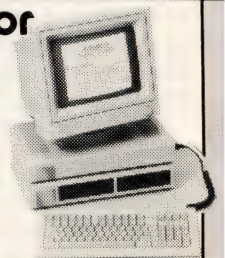

**\$686.50 !!!**  
Apple IIe  
compatible

## EMTEK HM-123

UNBELIEVABLE  
LOW PRICE!



22 MHz  
AMBER  
OR  
GREEN

Swivel base

## SAKATA SP-1200

120 c.p.s.

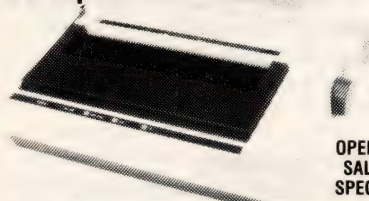

OPENING  
SALES  
SPECIAL!

DOT MATRIX TRACTOR/FRICTION FEED

## FLOPPY DISK DRIVES

Reliable TEAC  
mechanism



PRICE SO  
LOW YOU'LL  
HAVE TO  
SEE IT TO  
BELIEVE IT!

Apple compatible 40 track

bankcard  
welcome here



**EMONA COMPUTERS PTY LTD**

"THE TECHNOLOGY HOUSE"

1st Floor, 720 George St., Sydney, N.S.W.  
(above Mick Simmons Sports Store)

Ph: (02) 212 4815 or 212 3463 Tlx: 74500

IBM: reg. trade mark of International Business Machines Corp. Apple: reg. trade mark of Apple Computers Inc.  
EMTEK: reg. trade mark of Emona Computers Pty. Ltd.

Microprocessor — Trademark of Multitech Industrial Corp.

# your **BUSINESS** MAGAZINE **computer**

The Third Wave!

Consulting  
by Computer



**T**he issue of bankrupt suppliers has become particularly important to all computer users since the recent bankruptcy of Osborne Computer Corp and Victor Technologies, and expectation that other companies are facing similar financial difficulties. Problems among software vendors are even more frequent, but often, because the companies are smaller, these are hardly noticed by anyone but the trade press.

Often, the first reaction of users to a vendor bankruptcy is a chilled thought, "What will I do now?". The answer is, "Don't panic." The fear of doing without support is worse than the reality, and the problems are by no means as troublesome as they may seem at first. However, since the industry shakeout has only recently begun, there are few clear-cut guidelines on how to proceed. Few users have thought through a coherent contingency strategy.

Obviously, just because a vendor has stopped doing business does not mean a particular computer product will turn into a pumpkin overnight. The odds are that any product that's been successfully used for several months will continue to give good service. Thus, the key questions users must ask are:

- (1) Can I continue using this product without undue anxiety?
- (2) What are the costs of replacing this product immediately – is it worth going through the hassle of (for example) converting perhaps hundreds of data disks to a newer product?
- (3) In the event I decide to ignore the

vendor's business problems, what will I do if I suddenly run into a major problem and would ordinarily phone the vendor with a question?

(4) What is the cost comparison of locating someone who can repair the product, versus the costs of simply buying a new item?

These are questions each user must answer for him or herself. For example, suppose you have one or more plug-in expansion or special-function boards made by a now-defunct vendor, and one develops a malfunction. For the most part, boards have become commodity items, pretty much identical in use and function. This means that time spent in locating someone who can repair the board may well cost more than simply junking it for a replacement.

### What the Vendors Say

Vendors differ on the best approach to the problem. The president of one very successful aftermarket company said, "As far as expensive software is concerned, I wouldn't bother looking for a replacement if the software is functioning and meeting your needs – that's irrelevant to the company's financial status." However, a top official of another very successful company observed, "Since software is so inexpensive compared to hardware, getting a replacement package is really like taking out an insurance policy – you won't be tied to a defunct company, and you may find that the newer software is better in many respects."

(Every vendor with whom we spoke requested anonymity. "The stock market

is so psychologically crazy that even though we're doing very well, the market mistakes or identifies a mere spokesman with bad news from another company," explained one.)

This polarity of opinion about replacing software suggests that the first rule, when contemplating what to do, is to obey the law – in particular the second Law of Engineering which states, 'If it ain't broke, don't fix it.'

### Dump It

There are several guidelines on how to proceed if a peripheral actually breaks down. Suppose, for example, springs and other mechanical parts start popping out of your \$300 printer, and the vendor is long gone. Unless you place a low value on employee time, the most economical course here is probably just to dump the printer for a new one. It is often similarly uneconomic to attempt to get repairs on low-cost CRTs, modems, switches, and related items, especially when they are commodity items which can be replaced with little worry.

It is fairly common to find maintenance vendors buying up the parts and technical support material (circuit diagrams and so on) of vendors who have left the business. Thus, a call to one of the larger service vendors would certainly be in order. (If several of these are unable to help, that may be a signal that it's not worth pursuing the matter. Such a situation might well indicate that these vendors have decided the product is either inherently unstable, inherently poorly designed, or too expensive to try

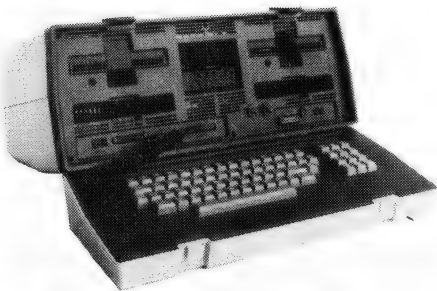

# ORPHANED?

to do repairs on. At least one popular computer gained some notoriety because of the failure rate of its disks).

With some items, individual repair personnel with special talent may be able to diagnose and economically repair electronic malfunctions. For example, suppose the power supply in a piece of non-mechanical, purely electronic gear goes bad. (Virtually all electronic items contain a built-in power supply — similar in concept to a transformer used with toy trains — which converts mains current into a form the hardware can use.) In principle, this item is repaired fairly easily, since it uses an almost universal design. In those cases, a quick phone call to a reliable repair depot might save \$200 or more.

Another source of comfort is user groups. Some members of user groups are virtual walking databases when it comes to knowledge of vendors. Often, they know who is repairing a certain product, or who bought the assets of the bankrupt company. Many computer magazines publish lists of user groups, and computer bulletin boards often have comprehensive lists of user groups.

If all else fails, and you're determined to get repairs on your board or other hardware, there is one last choice. If you know where the vendor was located, state records can sometimes indicate the disposition of a company's assets, or the names and addresses of former company officers. A company officer might know who has diagrams and other support material.

The same advice applies to entire computers. Odds are that others are in the same fix as you; truly, in unity there is strength. Of course, particularly in the case of whole microcomputer systems, it's important to weigh the cost of repair against the cost of a newer, probably more state-of-the-art unit.

# Don't Panic

*Bankruptcies among computer industry suppliers or vendors can throw a chill into even the hardest business person. The idea of being without a safety net is indeed scary — particularly since it's as easy to become dependent on a computer as on any other business tool, such as a telephone or line of credit. This article explains some of the options open to you if your vendor fails.*

BY HOWARD A. KARTEN

## A group of Osborne users cope

THE BOSTON Computer Society, in Boston, Massachusetts, is one of America's oldest and most prestigious computer user groups. The meetings of the Osborne users' sub-group of the Boston Computer Society just haven't been the same since Osborne Computer Corp got into the white water. "Oh, it has been an occasional topic of concern," says Peg LeGrande, co-ordinator (leader) of the group, with a great deal of dry understatement. In fact, LeGrande explains, the bankruptcy has been a topic of concern at almost every one of the monthly meetings held since the announcement.

The concerns of the group's 1062 members are primarily "who will be there to support them, how they will be able to get repairs when the hardware breaks, will they still be able to get software," LeGrande says. Although the Osborne machine runs CP/M, the software for it must still be prepared in an Osborne-specified disk format. This problem has been eased somewhat in recent months by the debut of several programs which allow users to read and write data in other machine formats.

Additionally, some members who have turned to other vendors would have done so anyway, as a result of changing needs.

Nevertheless, there is a conspicuous drop-off in the number of retailers and

software publishers who carry products for the Osborne. "Most retailers have completely washed their hands of Osborne owners, and local dealers, such as Computerland, seem to have said, 'forget it,'" LeGrande notes. Others are more cooperative, and will order supplies for Osborne users, if not necessarily stock those products.

Predictably, costs have risen. Although Xerox Corp's Americare program offers maintenance on Osbornes, it has two drawbacks: the cost is typically 15 to 20 per cent of the new machine purchase cost, and "Xerox won't do any time and materials repair work on the machine unless you have a warranty," says LeGrande.

Still, there are some sources of solace. The First Osborne Group (FOG), located in San Francisco, publishes a monthly newsletter where Osborne users can get their questions answered, and members of the Boston Osborne group often get advice and information from other group members.

LeGrande argues, "I understand the vendor's position, in terms of what they want to carry in their inventory, but considering that there are still 170,000 Osbornes out there, I think vendors, primarily retailers, are turning away sales." □

### Software

Things are slightly more complicated when it comes to software. One of the ironies of the computer age is that the lower-cost products — the software — are a greater potential source of problems than the higher-priced hardware. Getting stuck with a non-performing \$1000 software package can be potentially more devastating to a business than wisps of smoke coming out of a \$10,000 computer.

Unlike hardware, of course, software never wears out. However, it's not un-

known for a latent bug to surface; Murphy's Law holds that this will always occur at the most inopportune time. (Several leap years ago, at tax time, some mainframe software users found that software which had been performing properly for three years refused to acknowledge that February had 29 days.)

More often than not, software users are blissfully unaware when one of their vendors has gone out of business. Although it's probably not worth the effort to look for a replacement immediately, there are nevertheless two steps users should take if they learn that one of their

# Ford copes with Victor

IT WAS FAIRLY big news when Ford Motor Company announced that it had selected Victor Technologies Inc as its supplier in a large-scale purchase of micros. It was equally big news when Victor petitioned the Federal Court system recently for a Chapter 11 bankruptcy. (Under US law, bankruptcy is a federal proceeding. A company facing financial threat can petition the courts for either a Chapter 7 bankruptcy or a Chapter 11 bankruptcy. Under Chapter 7, a business whose debts exceed its assets is dissolved and the assets apportioned to the creditors. Under Chapter 11, the business states that it believes it can reorganise and get back on its feet. In this case, a court-appointed referee or manager oversees future operations of the company, which continues doing business – for a short time at least – with protection from its creditors.)

How is Ford coping with the Chapter 11 bankruptcy of Victor?

Very well, thank you, according to Ford's Executive Director of Systems, Mayford Roark. Ford currently has approximately 1100 Victor units in-house, and, thanks to a fortuitous sequence of events, is not especially nervous.

"What occurs to you right away is service," Roark explained in a phone interview from his Dearborn, Michigan, office. "We decided some time ago to service most of our office automation equipment in-house. Ford Aerospace, a subsidiary of

Ford Motor Company, does a lot of work servicing electronic equipment, so we contracted with them some time ago to service much of our hardware. Thus we're not vulnerable to a supplier going out of business, and we are able to maintain consistent service levels to our users." Because of the size of Ford's order, Victor had set up a training facility near Ford headquarters in Dearborn, and Roark was impressed with the zeal and ability of the Victor personnel assigned to his account. When Victor went into bankruptcy, "That group went into business themselves as a training facility, and they're handling Victor training as well as looking for business opportunities for training in related fields," Roark said. "This crowd has done a first-rate job; they've become entrepreneurs, and we've had excellent support from them." In addition to Ford's 1100 systems, some 200 Ford employees have purchased Victor hardware on their own. This makes Ford about the largest Victor user community in the country. The result has been a large number of unsolicited contacts from other Victor users.

Ford Aerospace has a considerable amount of information from Victor on the internal workings of its computers, so – for the time being at least – Roark appears not too worried. His advice to others in similar situations? "Be particularly concerned about the service aspect. Make sure you have a source of service that can be sustained." □

software vendors is no longer in business:

(1) Make sure that the data stored on a disk by a program can be put into a format that allows it to be easily transported to another product. (Actually, of course, this should be one of the key considerations in buying a product in the first place.) For example, you may have a spreadsheet package that stores data in its own particular format which cannot be read easily by any other package. If you have a lot of files on disks, and the vendor goes out of business, the conversion effort could be wrenching.

(2) If you don't already have it, see if you can obtain a copy of the source code. (Source code is the language a program is first written in, such as BASIC, Assembly language, C, and so on.) Understandably, vendors prefer not to give this out, since source code is usually their chief asset. Obtaining source code is probably a last-ditch insurance effort: if you do subsequently have a serious software problem, you or a consultant might be able to use the source code to correct the problem.

If you're using a software package happily, and the vendor is now out of business, it's probably safe to put off replacing it as long as possible. In general, the history of software development is that succeeding products improve upon earlier ones in every way; newer software is usually faster, more flexible, and more powerful than earlier products. Sometimes, it is less expensive as well. Odds are, the longer you can put off the purchase, the better the software you'll come up with.

At the same time, it would certainly be a wise idea to locate other sources of support. "A successful software product will have built a considerable following, so you will typically find a variety of books, aftermarket software for the principal software, and so on," suggested a key official of a successful firm. Often, these can be located by a search of computer publications (especially an on-line search).

Getting in contact with individuals from those firms can be valuable. If they have enough knowledge to develop and market a useful adjunct product, they

probably have a fairly good knowledge of the main software. In many cases, these companies will be happy to sell consulting services to a user. (This same advice applies to the original authors of software which is no longer being sold: the original authors may be willing to sell their consulting services to users, if they can be located. Despite the apparent size of the computer industry, it frequently takes no more than three or four calls to locate a particular author or marketer.)

## If All Else Fails ...

Let's assume that all your other efforts have failed, and you are now faced with having to change over to a replacement software package. Without a doubt, conversion is the most onerous, distasteful, stressful task faced by any computer user (as mainframe software users long ago established). If your purchase of replacement software is large enough – say, 20 copies of a \$500 integrated business product – you may be able to negotiate to get the vendor to do your conversion for you. Large vendors are often willing to negotiate such deals because of the revenue, advertising or referral value, or other considerations they get.

One option that shows signs of growing is escrow accounts for software. This idea, which has been kicking around the computer industry for 15 years or more, in principle offers an attractive choice. The idea is quite simple: at the time the user buys a software product, the user and the vendor jointly provide for a third party to hold the source code or other supporting materials. Then, if the vendor eventually goes out of business, the escrow agent is allowed to release the source code to the customer.

Although escrow law is well-established, and the use of escrow agents is growing, there is still a bit of uncertainty when the concept is applied to software, cautions a US attorney, Bob Bigelow. "For example, there's the whole matter of verification – how do you know the source code in the escrow agent's hands is the code you're actually using?" he asks.

One wrinkle, for example, is that "the source code is the only thing of value a software company has. If there's any real value to it, someone will bid on it and may continue its maintenance."

Bankruptcies that have occurred so far seem not to have most users unduly alarmed. Undoubtedly, vendor bankruptcy is much less catastrophic for users than it first appears; proceeding logically – and calmly – will probably get any user through the troubled times. □



"It's almost certainly better than IBM's Pascal for the PC... Recommended."

**Jerry Pournelle**  
Byte, May 1984.

And Now It's Even Better  
Than You've Heard!

# It's TURBO PASCAL<sup>®</sup>

● EXTENDED PASCAL FOR YOUR IBM PC, PC jr., APPLE CP/M, MSDOS, CP/M 86, CCP/M 86, OR CP/M 80 COMPUTER.

- Windowing (IBM PC, XT, jr. or true compatibles)
- Color, Sound and Graphics Support (IBM PC, XT, jr. or true compatibles)
- Optional 8087 Support (*available at an additional charge*)
- Automatic Overlays
- A Full-Screen Editor that's even better than ever
- Full Heap Management—via dispose procedure
- Full Support of Operating System Facilities
- No Licence Fees. You can sell the programs you write with Turbo Pascal without extra cost.

Yes. We still include Microcalc...the sample spreadsheet written with Turbo Pascal. You can study the source code to learn how a spreadsheet is written...it's right on the disk.\* And, if you're running Turbo Pascal with the 8087 option, you'll never have seen a spreadsheet calculate this fast before!

\*Except Commodore 64 CP/M

## \$89.95

incl tax

Order Your Copy of TURBO PASCAL<sup>®</sup> VERSION 2.0 Today

## SIDEKICK<sup>™</sup> Turbo Toolbox<sup>™</sup>

JUST A KEYSTROKE AWAY...  
NO MATTER WHAT SOFTWARE  
YOU'RE RUNNING!

- A CALCULATOR
  - A NOTEPAD
  - AN APPOINTMENT CALENDAR
  - AN AUTO DIALER
  - AN ASCII TABLE
  - AND MUCH MORE
- ALL AT ONCE...OR ONE  
AT A TIME.

ANYWHERE ON THE SCREEN YOU LIKE.  
ANOTHER KEYSTROKE, AND YOU'RE  
RIGHT WHERE YOU LEFT OFF  
IN YOUR ORIGINAL PROGRAM!  
(you never really left!)

**\$79.95**  
incl. tax

Available only for the IBM PC, XT, jr. and Compatibles

Dealer enquiries welcome.

AUSTRALIAN DISTRIBUTOR



*Software City*

PHONE (02) 621 4242  
(02) 671 6951

1/27 Forge Street, BLACKTOWN  
MAIL: P.O. Box 62, BLACKTOWN, 2148



We've crafted some special tools to help you create the best PASCAL programs in the least amount of time. Designed to complement the power and speed of TURBO PASCAL. These are functioning modules.

**\$79.95**

**BORLAND**  
INTERNATIONAL

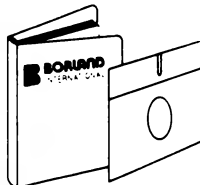

STOP PRESS

### TURBO TUTOR

Teaches step by step how to use the TURBO PASCAL development environment—an ideal introduction for basic programmers.

### TURBO GRAPHICS

Create your own graphics with TURBO PASCAL.

Available early 1985

We support all our Software.

My system is: 8 bit  16 bit

Operating System: CP/M 80

CP/M 86  MS DOS  PC DOS

Computer: \_\_\_\_\_

Disk Format: \_\_\_\_\_

Please be sure model number & format are correct.

Name: \_\_\_\_\_

Address: \_\_\_\_\_

Telephone: \_\_\_\_\_

N.S.W. add \$3.50, Interstate \$5.00, Overnight \$6.00 per order.



# UPGRADE OR BUILD

with  COMPUTER SYSTEMS (AUST) P/L

## YOUR OWN COMPUTER

IF YOU WANT TO LEARN ABOUT COMPUTERS OR IF YOU ARE ALREADY AN EXPERT, THERE IS ONLY ONE WAY TO THE FUTURE — BUILD YOUR OWN.

Q.T. Computer Systems have been supporting the hobbyist and educational market for the past four years and now from our own premises at Gladesville, offer a whole range of new products most of which are wholly designed and manufactured in AUSTRALIA.

### SUPER 80 ADD—ONS THE UNIVERSAL FDC

- \* Can operate up to 4 8" or 5 1/4" disk drives with any Z80 based computer
- \* Includes DMA
- \* Uses WD2793 Controller
- \* CP/M routines for most popular Z80 systems

### SUPER 80 VIDEO BOARD VDUEB

- \* 80 x 25 screen format
- \* Graphics resolution 225 x 560 dot addressable
- \* Graphics software available

### SBC 2/4 CPU BOARD

- \* Z80A CPU
- \* 2 or 4 Mhz switch selectable
- \* Two programmable timers
- \* DMA compatibility allows MWRT signal generation on CPU
- \* Serial port
- \* Parallel port
- \* Bareboard kit or assembled & tested

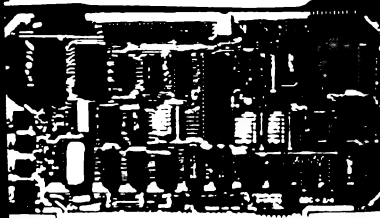

### FDC-1 SBC

- \* Z80A 4 Mhz or Z80H 8Mhz
- \* 2 Serial ports
- \* 2 Parallel ports
- \* NEC 765 Floppy disk controller
- \* Up to 8k of Ram or Rom.

Just add memory and you have a complete system capable of a very easy upgrade to multiuser or multiprocessor operation.

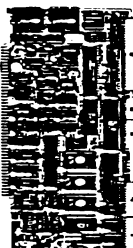

### 5 1/4" and 8" DISK DRIVES

From 150k to 1.6 megabytes of storage. TEAC, MPI, CANNON or YE-DATA, full size or new slimline.

Prices start from \$216 plus tax.



## SAVE YOUR 8 BIT SYSTEM Join the 16/32 Bit Revolution Through Evolution

Would you like to run CP/M86, CONCURRENT CP/M86, CP/M68K, MS-DOS, IBM PC APPLICATIONS, DEVELOP and TEST 16/32 BIT SOFTWARE, or add an INTELLIGENT HIGH SPEEDRAM DISK TO YOUR SYSTEM?

You CAN with the HSC CO16 ATTACHED RESOURCE PROCESSOR:

An 8 bit system equipped with CO16 retains all of its original compatibilities PLUS it has the added ability to run most 16 bit operating systems and applications.

Prices start at \$995.00 which includes the CO16 processor with 128k bytes of memory, two volume user manual, and the HSC Software Development System Hardware options, including memory expansion to 768K bytes, attractive desk top enclosure with power supply and the INTEL 8087 Math Co-processor (available on CO1687 only). Software options include CP/M86, CP/M68K, Concurrent CP/M86 or MS-DOS operating systems. The UNIX operating system will be available late 1984.

CO16 with either 8086 or 68000 16 bit microprocessor and up to 768k Bytes of parity checked RAM may be connected to virtually any Z80 based computer system or APPLE IIE computer system.

### Conduct your CP/M with more power than ever before!



- MDRIVE — ADD AN EXTRA DISK, FASTER THAN HARD DISK
- CACHE Q
- CP/M 3.0
- 8 MHz CPU UPGRADE
- MICROHELL
- JRT PASCAL 3.0
- CP/M USER GROUP LIBRARY
- ACCOUNTING SOFTWARE IN SOURCE CODE
- PCB DESIGN SOFTWARE FOR CP/M

### ADD-ONS AND UPGRADES GALORE

We offer generous discounts for clubs, user groups and educational institutions. Call for details. Choose from one of the most extensive ranges of software in Australia. Too many to list. Phone us with your requirements.

### CABLES

If you would rather not make your own cables, Q.T. can fill all your cabling requirements. For disk drives, printers or special application.

### DISK CABINETS

House your floppy disk or hard disk drives in our handsome metal cabinets with rugged power supply. Suits 1 or 2 x 8 or 1 or 2 x 5 1/4 inch disk drives.



### HARD DISK SUBSYSTEMS (THE SOLUTION)

Reliability and expansion capability are the best words to describe our solution to your storage needs. Most Z80 based or Apple computers can be upgraded to hard disk at a cost too low to advertise. Hard disks and controllers available separately for you to "do your own thing".

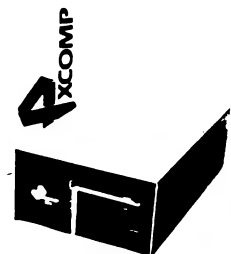

### MAINFRAMES

Q.T. mainframe cabinets, we believe are the most versatile on the market today. They will accommodate 4, 6, 8 or 12 slot motherboards, 5 1/4" or 8" disk drives as well as up to 2 x 5 1/4" hard disks. Just add your S100 boards, a terminal and you have an inexpensive high quality computer.

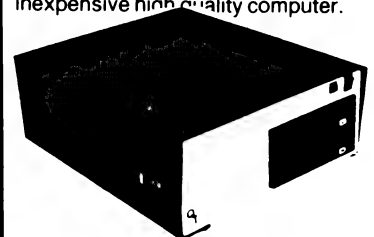

DEALER  
ENQUIRIES  
WELCOME



140A Victoria Road, Gladesville NSW 2111

Phone: (02) 816-4044

FREE MODEM "HOT LINE" MEMBERSHIP Fast overnight airmail delivery cost \$1.00 p/kilo (min \$5.00)



COMPUTER  
SYSTEMS

Phone  
(02) 896 1044  
(02) 816 4044

*Expanding a medium-sized tax consultancy business into a large, fully computerised, multi-user professional consulting service is quite an ambitious task; two businessmen in New South Wales are planning to do just that.*

# Consulting by Computer

A comprehensive professional consulting service – offering small to medium-sized businesses computerised accounting systems, legal facilities for the formation of companies and drawing up of wills, superannuation and retirement funds, taxation and investment advice and insurance on life, income protection and motor policies – is being planned by two accountants who hold H. and R. Block franchises in several Sydney suburbs. The operation, which one of the partners, David Baker, claims will be the largest of its type in New South Wales outside the major chartered accountant firms in the city, started as a taxation advisory and accounting service in eleven suburbs, and is expected to grow to its full size over the next two or three years.

H. and R. Block is a US-owned accountancy chain which owns a number of tax offices throughout Australia, and has franchised its name to other participants in large cities. During this year, David Baker, who holds franchises at Hurstville, Rockdale, Bexley, Riverwood and Roselands Shopping Centre, and his partner, fellow accountant Dennis Michelmore, who has similar offices at Gladesville and Bondi Junction, have combined to form H. and R. Block Financial Services, which they have jointly extended to include Merrylands, Granville, North Parramatta and Cabramatta.

“Although we will be competing against about nine major firms, we believe there are considerable opportunities in the outlying areas of Sydney and regional centres within New South Wales with business people who cannot afford to pay the high rates that large firms charge,” David Baker said. Although he and his partner will be responsible for the accounting services, some of the other facilities such as legal advice and insurances will be arranged in co-operation with local solicitors and

agents. “In about 18 months, we hope to be the largest investment dealers in Australia, with 83 outlets in New South Wales, but we are still waiting for Corporate Affairs Commission final approval,” he added. Among places tentatively targetted for the future are Leeton, in the Riverina, Canberra and the Hunter Valley.

## Growth Based on Computers

Their plans for growth are being founded on two Discovery 16-bit multi-user computers supplied by Archives Computers of Melbourne. The larger computer, with 45 megabytes of storage, is located at Hurstville, and the second, with 22 megabyte capacity, is situated at Gladesville. Each is being operated as a stand-alone unit, with the multi-user facilities being used by office staff, who can access the various files while working on different jobs.

Archives' ACC-SYS software is being used for accounting jobs, and the Datasflex database system for client lists and records. As the business expands, the Hurstville office will become the computing centre, with 14 employee users dealing with branches linked to that system, while Gladesville will have a capacity for seven users, most of whom will be at remote sites. The users may be clerical staff at the branches, or the professional core of accountants, solicitors and other advisers and consultants working with the partnership in its various activities.

Except in rare instances, commercial clients will not have direct access to the computer systems or be able to participate in any of the processing through their own terminals. “The availability and potential of multi-user processing from a series of co-ordinated professional offices rather than individual client sites, and the ability to have a number of customers on-line at the same time were important criteria in our decision to buy

this type of system,” Mr Baker said. At present, the firm's services are providing tax and accounting tasks for small businesses such as the setting-up of books, debtors and creditors control, provision of regular income statements and balance sheets, and full accounting and taxation paperwork.

## Software Grows with Needs

The Archives Datasflex database system is numbered among the fourth-generation languages designed to allow users with little practical experience in computing to update all files in the system simultaneously. Its installation was an upwardly mobile leap for David Baker, who had been using previously – and still has in the office – a personal Kaypro 10 portable.

The Discovery systems are also being used for word processing jobs such as appeals to the Taxation Office, general correspondence, reports, standard forms and legal documents. Archives delivered the computers last May, and they were running by June just as the taxation returns season was reaching a peak. It was not entirely a case of all going well from the outset, but problems in the software systems were fairly rare, and were soon overcome. “One of the few failures was the lack of a good manual, but this is now being revised,” David Baker said.

When the complete system is implemented, each of the clients serviced by the H. and R. Block Financial Services operation will be entered into the computer base as an accounting, taxation, portfolio investment or ‘other’ customer. Work in progress will be monitored regularly, and the system not only has facilities for updating records but can estimate and forecast likely results in a variety of money transactions, a valuable feature for monitoring the future of investment prosperity in Australia. □

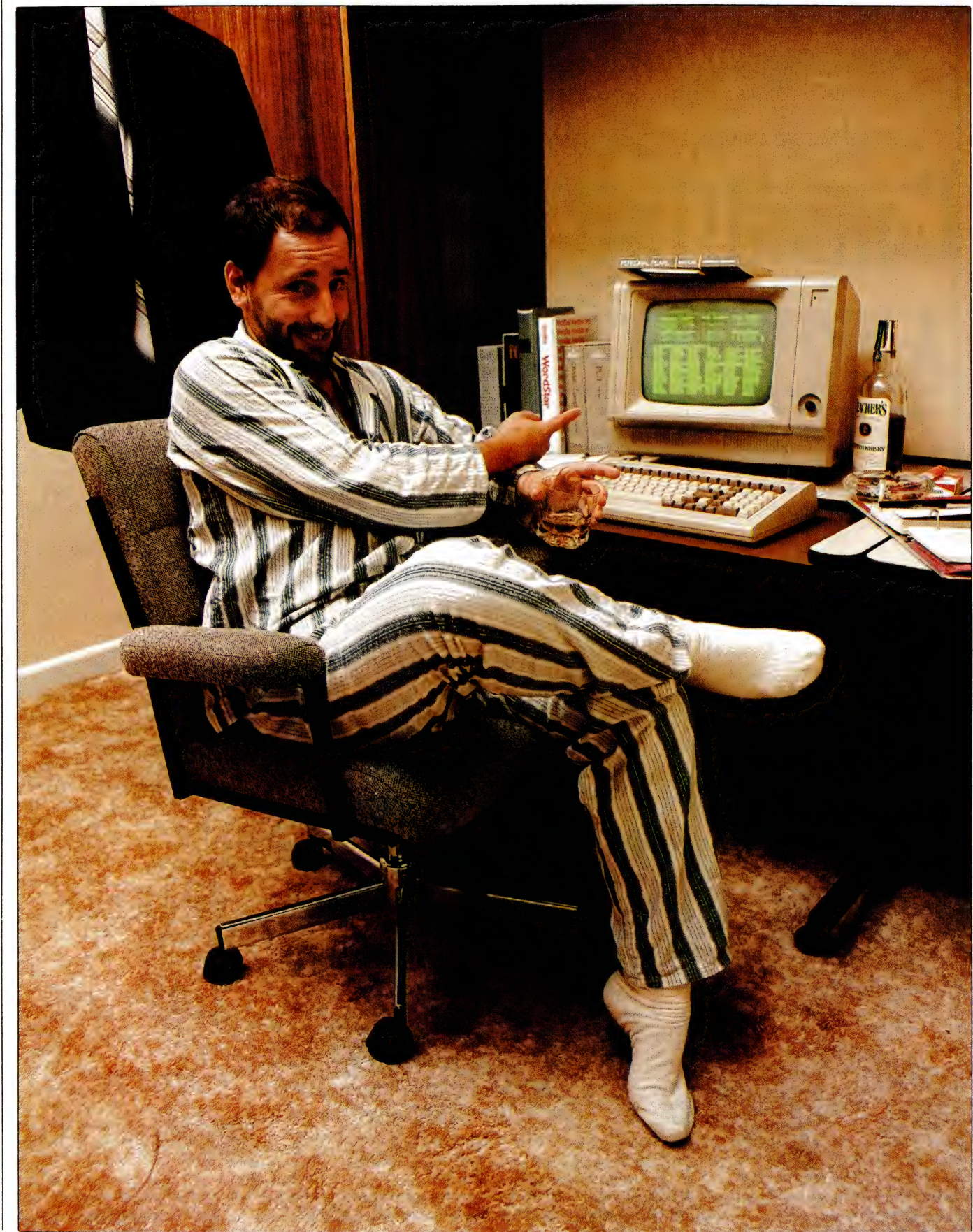

*There's been talk for some years of microcomputers and networks bringing about a new kind of high-tech cottage industry, with all kinds of white-collar workers able to work from home and communicate with their head office via a computer. In England, Rank Xerox has been one of the first large companies to actually put this idea into practice.*

# The Third Wave!

BY SONIA BEESLEY,  
Contributor to the BBC, London

**"M**y eight year-old son asked me only this morning, 'When are you going back to work, Daddy?', and I had to laugh because I was up at five and had done three hours work already!"

Roger Walker was talking to me in his office, a pleasant room next to the kitchen at his home in Milton Keynes, a new town 60 km north of London. He likes working there early in the morning when the house is quiet and much prefers that to battling with London's commuter traffic.

For years, Roger Walker worked as an executive for Rank Xerox at the company's head office in the centre of London. He is still working for the company as a part-time consultant, but now has his own firm and several clients. In Rank Xerox he is known as a networker and is part of an experiment in new patterns of work that the company is pioneering in the United Kingdom. It is an experiment that has aroused a great deal of curiosity and led many people to wonder – like Mr. Walker's small son – how you can be working for a company without being there; without actually 'going to work'.

The answer lies in the microcomputer, supplied by Rank Xerox, that sits on Mr Walker's desk. By means of an acoustic coupler attached to his telephone, he can link up with the main computer at Rank Xerox headquarters and send and receive material on its screen. Mr. Walker's field is personnel management and, on the morning I visited him, he had just completed work on some lengthy employment contracts which he then transmitted to London via the microcomputer in a matter of minutes.

## Voluntary Scheme

The idea of networking arose out of an

attempt by Rank Xerox to solve a problem common to many large companies – namely, the rising costs of offices and staff. Rents and rates have risen sharply in London – and in most large cities – in recent years, as have the costs of pensions and national insurance contributions and of providing facilities such as car parks and canteens.

In November 1981, Rank Xerox found that an employee whose salary was 20,000 pounds a year actually cost the company 60,000 pounds when all these costs were added. It followed that if that employee could work as effectively at home, substantial savings could be made. The technology to make this possible was already available, including office equipment such as communicating microcomputers, at an increasingly low cost. It began to make sense to invest about 3000 pounds (around \$5000) in such equipment and send the employee home.

Rank Xerox introduced the idea of networking on a volunteer basis; no one was actually forced to work at home. Mr Walker was the first to volunteer and over the last two years 43 others have joined the network. They include specialists in finance working on tasks such as analyses of pension fund investment, and marketing experts developing programmes for the launch of new products or analysing sales figures.

Many more employees applied to be networked from home, but the company selects networkers carefully and on two main criteria: are their jobs suitable for networking and are they themselves capable of running their own business? Obviously, not all jobs can be done away from the company's office; for example, for a cashier or receptionist being there is essential. This is not so for a computer

programmer. In this job output is all-important and location irrelevant, and several British companies already employ computer programmers in this way. But networking is quite different from normal home-working; at Rank Xerox, the networker is his or her own boss.

## Fiercely Competitive

In developing the concept of networking, Rank Xerox was conscious of three trends in society that were bringing about changes in the way work was done. The rising cost of employing office staff and the development of new office technology have already been mentioned; the third was the growing desire of individuals to manage their own business. Rank Xerox was aware that in recent years several of its employees had opted to leave secure jobs in the company to become entrepreneurs in spite of the risks involved, and that they had succeeded by dint of their commitment and enthusiasm.

The company therefore saw networking as a means of retaining the services of talented employees they did not want to lose, while helping them realise their own objectives. The networker forms his/her own company, works under contract for Rank Xerox on specific tasks that take up to 50 per cent of his/her time, and sells the rest of the time working for other clients.

It was getting work from other clients that Mr Walker found hardest at first. "You don't have to sell yourself inside a large multi-national, but it's cold out in the world of the small businessman – and fiercely competitive," he said. Not only did Mr Walker have to become his own salesman but his own accountant and secretary too. And working at home was not as easy as it sounds, requiring enormous self-discipline.

**Synax Systems**

The complete hardware  
and software solution  
for your business.

Multi-processor hardware  
that grows with you.  
Delivering consistent  
performance as you expand  
from 1 to over 100 users.

Multi-user business software  
that really works for you.  
And, of course, you can run  
standard packages like  
Wordstar, Lotus 123  
and dBase.

The power that you need.  
Large hard disks, tape backup,  
fast 280B and 80186 CPU's  
TurboDOS operating system,  
dual Bus architecture (S100+IPC)

**The Multi-processor Solution****synax****Synax Systems Pty. Ltd.**

"Setting new standards  
in price and performance"

Dealer Enquiries Welcome

**(02) 467-1166**

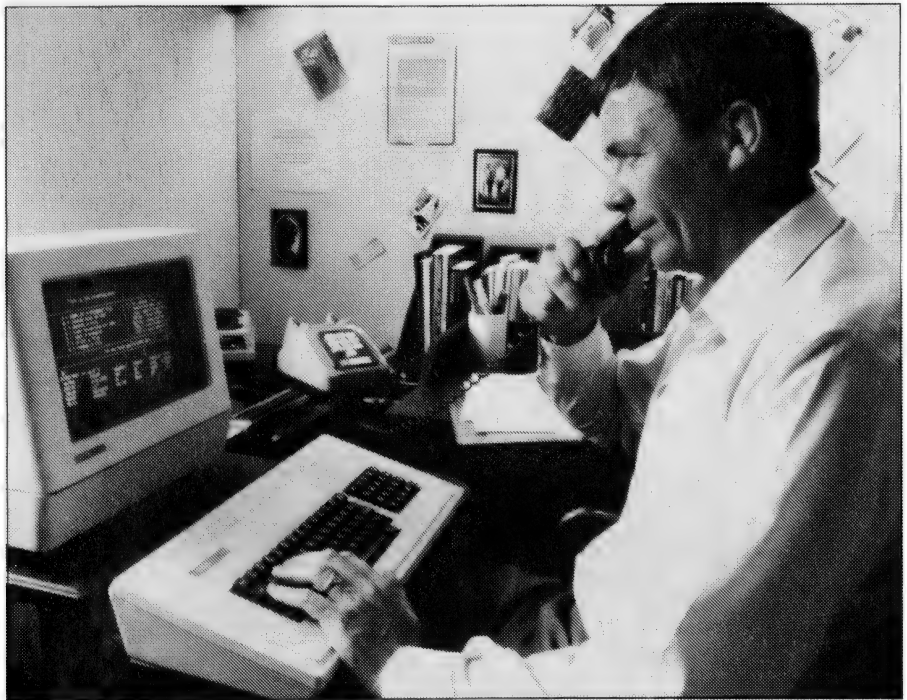

**Roger Walker, one of the pioneers in Rank Xerox's employee networking arrangement.**

Loneliness was a problem at first, and an unexpected one. Mr Walker found he missed the company of colleagues. He missed the canteen too – and most of all, the company car. But his wife was 100 per cent behind him in his ambition to 'go it alone', and he sees this as essential for a networker with a family. Even with a two-year contract such as Mr Walker had from Rank Xerox, it can be difficult at first, and he was prepared for an initial drop in income. The important thing is that he now sees the potential for building up a very successful business. "It has really met all my objectives. Ever since I left university I wanted to set up my own business. It's tough out here – but it's terrific; it's the freedom – it's being your own boss."

**Resilience Required**

Rather like an anxious parent whose grown-up children leave home for the first time, Rank Xerox keeps a watchful eye on the progress of its first networkers, giving practical help wherever possible while encouraging them to be fully independent. There are training programmes covering all aspects of setting up in business, from planning and marketing techniques down to such mundane things as registering for

taxation purposes. There is also an opportunity to consult careers guidance specialists before taking the plunge.

While it cannot identify a single entrepreneurial type, Rank Xerox has found that a determined optimism and resilience plus an outward-going character are essential attributes. There is now an association of networkers and other ex-Rank Xerox employees who have started their own companies; called Xanadu, it holds regular meetings to thrash out mutual problems, share ideas and counteract the feelings of isolation and loneliness that most, like Mr Walker, experience at first.

Rank Xerox is delighted with the results of its networking project, though it insists it is still very much in the experimental stage. Derek Hornby, the director in charge of the company's headquarters, said: "To us it is achieving our main objective – to retain the experience and loyalty of valuable employees who, because of rising costs, we might have been unable to afford in the long term. It has also enabled us to understand better the nature of our own products – such as the microcomputer – and demonstrate their flexibility." A number of other large companies has already expressed interest in networking as a new way of organising work. □

# QUALITY FROM CALIFORNIA U.S.A.

**OSM** Computer Corporation's Zeus V.I.P.C. illustrated below is right on the forefront of technology. Featuring strict IBM PC compatibility, while at the same time offering a 20MB hard disk system with 20MB cartridge back-up, OSM quality is apparent both cosmetically and 'under the lid'. Strict IBM compatibility extends to software and hardware. OSM offers one of the widest range of systems and options. Unlike some other PC makers OSM offers upgrades for your system as your business grows. OSM's prices are around 80% of IBM's. However, customers really buy OSM because of the superb quality.

- Up to 20MB Hard Disk. (Internal)
- Up to 70MB Hard Disk. (External)
- 20MB Cartridge Drive. (Internal)
- Communications Options for IBM, HP, DEC, Others.
- Color/Amber/Green Screens.
- Full Graphics.
- Real Time Digitising.
- Runs IBM PC software and software developed for IBM PC's



OEM DISCOUNTS AVAILABLE

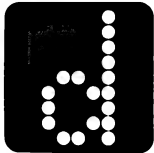

**datatel**

## **datatel pty ltd**

19 Raglan St South Melbourne 3205. Tel (03) 690 4000  
80 Chandos St St. Leonards 2065. Tel (02) 439 4211  
S.A.—Applied Data Control (08) 79 9211  
W.A.—Computer Communications (09) 458 9752  
QLD.—Computer Communications Services (07) 368 1641

## COMPUTER MAINTENANCE

Prompt service on all  
Microcomputers and peripherals.

Service agent Anadex,  
NDK, NEC, printers.  
All ribbons and diskettes  
in stock.

Computer and peripheral  
Hiring Service.

1st Fl., 202 Blackburn Road,  
Mt. Waverley, 3149.  
Phone (03) 232 6733

**NUCLEUS**

Computer Services Pty. Ltd.

## ULTRA RELIABILITY AT 100 CPS, WP-1000 PRINTER

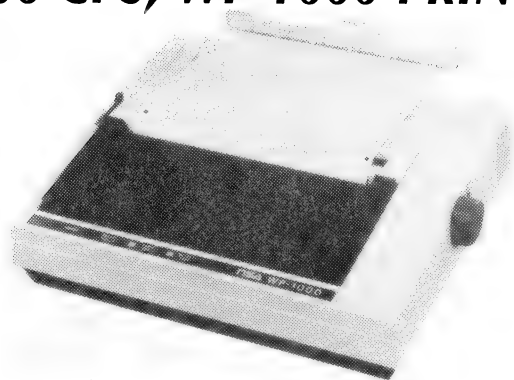

- ★ Clearly formed dot matrix characters: 9x11 dots
- ★ High through-put with bi-directional/Logic seeking (66L/M)
- ★ Both Centronics and RS232c built in
- ★ Paper back-feeding by software
- ★ Fanfold paper, roll paper & cut paper
- ★ Easily detachable print head

**DEALER INQUIRIES WELCOME**  
For further information contact:

**Nissei Sangyo Co Ltd**

**NSA**

INCORPORATED IN JAPAN  
200 PACIFIC HIGHWAY, CROWS NEST  
N.S.W. 2065 AUSTRALIA

TELEPHONE: (02) 923-1522  
TELEX: AA70941  
FACSIMILE: (02) 922-2498

# It Reads, Writes and does Arithmetic. It Paints in 3-D, Keeps Your Appointments and Talks to the World.

OPEN ACCESS is now available  
for the following MS DOS/PC DOS microcomputers:—

AT&T PC; Chamellion; Columbia; Compaq; Corona; Data General;  
DEC Rainbow; Eagle; Emtex; Ericsson; Friend; HP-150; Hyperion; IBM PC;  
ITT Extra; Monroe; NEC APC III; NCR Decision Mate V; Olivetti M24;  
Pantek; Philips PC; President; Sigma Elite; Sperry PC; Tandy 2000;  
TeleVideo; Texas Instruments PC; Toshiba T-300; Wang PC; and Zenith 150.

## O·P·E·N ACCESS

“OPEN ACCESS,” is the result of 60 man-years of effort to create a truly do-it-all, super-program — one that can perform virtually every task you're ever likely to encounter.

The beauty of it is, all that capability resides on a single program. You don't have to re-enter data. Or spend time trying to get unmatched programs to work together.

OPEN ACCESS takes its name from the source of its power — a relational data-base manager that gives you access to more data in more ways than any comparable software.

OPEN ACCESS includes an electronic spreadsheet, 3-D graphics, word processor, appointment scheduler and telecommunications module — all revolving around the powerful information manager.

For your nearest  
dealer contact the  
Australian distributor...

**S** SOFTWARE  
SUPPLIERS

7 Avon Road  
North Ryde, NSW 2113  
Telephone (02) 888 1955  
Telex AA 75364

*In an age when more people are using the local corner store to buy milk rather than having it delivered to their doorstep, milkmen in Western Australia are taking a closer look at a new software package designed especially for their trade.*

# Milk Manager

BY DEREK MORRIS

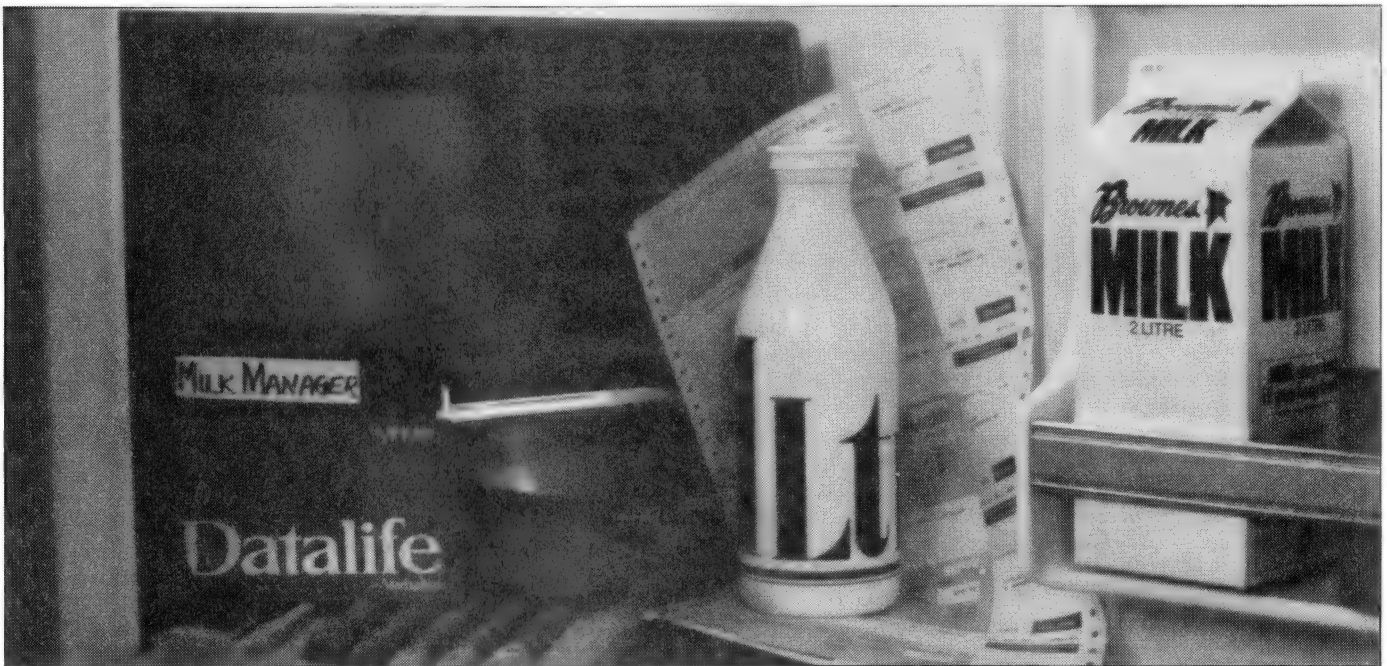

**A** milkman's round is not an easy one. These poor blue collar athletes have for a long time survived all the perils of the suburbs only to find themselves additionally subjected to mountains of notes left under milkbottles, mouthfuls of impossible requests, and fistfuls of account queries – all of which must make them despair of their choice of profession.

Milkmen (*for the sake of convention we'll call them that, even though we're aware many women do this job too; a quick poll round the office couldn't come up with a suitable alternative, 'milk person' being universally derided and 'milk vendor' sounding more like the original dairy or a corner store – Ed.*) must deal with numerous requests from customers, and try to cater for their every whim in order to retain their custom. Therefore any software package claiming to manage a milkman's round would have to be

equally versatile and accommodating.

Milk Manager is a program which was written especially for milk vendors and distributors. It is designed to take care of the running of a milkman's round and remove some of the drudgery from account keeping.

### What you get

Milk Manager is sold as a complete package including a Sanyo 16-bit computer

(of the IBM ilk), an 80-column printer, blank disks, and printer form paper. The all-up price for this package is \$4195 including tax.

If you already have a Sanyo micro-computer and don't want to purchase a complete package, Milk Manager can be purchased alone for \$895. A version for other IBM clones is currently in the making, and should be released in the near future. The Sanyo has two 360K

### SOFTWARE DETAILS

Program:	Milk Manager
Made by:	Computer Country
Hardware required:	Sanyo 555 business computer
Price:	\$4195 (complete system); \$895 (software alone)
Review package from:	Computer Country, 1st floor, Cnr. Roe/Fitzgerald St, Perth 6000. Phone: (09) 328 4644.

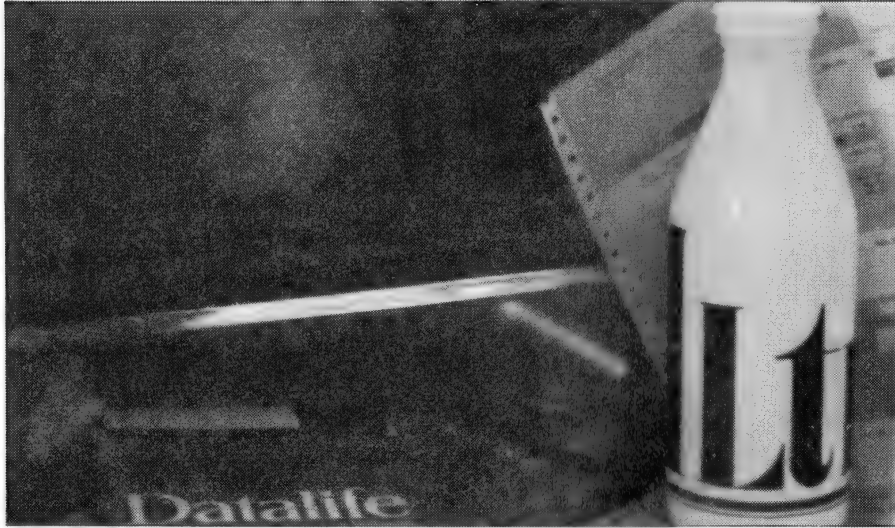

drives, 192K RAM, and runs Milk Manager in Sanyo BASIC – a 46K dialect of BASIC, similar to Microsoft's.

Like most business programs Milk Manager is menu driven, and as soon as you load it displays eight options, each of which leads to a further menu. The eight options on the main menu correspond to the major program modules of Milk Manager, and give you some idea of what the package can do.

The first option manages a customer list, which enables you to enter new customers, modify details of existing ones, or to make an enquiry on a present customer. The information on each customer is quite detailed, including the side of the road the customer lives on, when the customer goes on holidays, their credit limit, and an invoice period. It also includes the usual information on customers' current balances, whether they are retail or wholesale buyers, and so on – George Orwell would be proud.

Option two on the main menu deals with the product line the vendor carries, and allows a detailed description of each product in the range and supports full editing of the list. It keeps tabs on the supplier of each item, the product price (cost and retail price) and the number of each product left over from the previous day's delivery. This last feature adjusts the quantity of the next purchase so the surplus products are not over-ordered.

Options three to five of the main menu cover everything from producing a complete list of the day's delivery to

invoicing and generating reports. These three sections seem to be the 'guts' of the entire package, and they cater for some fairly sophisticated transactions.

At a moment's notice the vendor can find out how he or she stands with the dairy ordered from, enter supply requests made by customers whilst on the round, or perform all the necessary bookkeeping.

The three remaining options on the main menu cover a utilities section which maintains all the data and customer details, a help file which supplies information on the system's workings, and finally an exit routine which closes all the active files and saves them to the disk.

The manual that comes with the software is of the glossy and brief variety, but not at the expense of being inadequate. It seems to cover all the areas of the program well, without getting bogged down in too much detail.

It explains all the routines in the package quite clearly by showing examples of the possible data input for each section, and explains the choices available at each stage of the program's execution.

A large portion of the manual is devoted to introducing the user to the concept of computer care, including the importance of treating diskettes properly. In fact, the bulk of this section dwells on the implications of not making archival copies of the system's data and back-up copies of those disks.

It cites an example of fire damaging a company's premises, whereby every-

thing is covered by insurance but the precious data on the diskettes – not quite material for a film script, but a very valid point nevertheless.

### Easy to Use

In trying out the Sanyo/Milk Manager package I found it worked well with all the examples I typed in, and acted on that data accordingly – I delighted in ordering milk, cream, and yogurt for several John Smiths in the fictitious suburb of Spilt!

I was initially sceptical about Milk Manager being written in BASIC for, like most people, I tend to forget that BASIC is an acronym and not an adjective. Unfortunately, BASIC is the last language that comes to mind when I think of business programs, and I tend to frown upon programs which use it.

However, in this case it works very well. In fact, if you didn't know Milk Manager was written in BASIC there would be little to arouse your suspicion. It runs quite fast, as almost all the program resides in memory when loaded, and the disk drives are only called upon for data manipulation and loading some minor routines.

The program flow throughout Milk Manager impressed me very much. Even a person with little knowledge of the milk vending industry – or even business procedure – will have little trouble in making sense of the program – it's almost impossible to 'lose' yourself within the program structure.

The appearance of the program while running is thankfully quite sedate, being devoid of any 'bells and whistles' or breath-taking graphics; nothing must be more disconcerting than being led through a series of beeps, flashes and useless pictures in a program which controls the fate of your business.

Milk Manager struck me as an excellent example of our local software industry catering for a comparatively small sector of the business community. Apart from the odd package written for doctors, newsagents and video libraries, our software industry seems to gravitate around writing programs for the proven markets only – an unfortunate situation for a nation teeming with a huge number of very diverse small businesses and many talented software writers. □

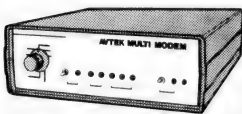

### AVTEK MULTI MODEM

**Features Auto Answer!**  
(Unlike cheaper version)

- ★ 300 baud full duplex, 1200 baud half duplex or 600 baud half duplex, answer or originate
- ★ CCITT and Bell standards
- ★ Plugs straight in (hardwired phone)
- ★ Superior VLSI chip performance works reliably with -4dBm signal with S/N ratio of 6dB Error rate on this level is 10<sup>-5</sup>
- ★ Telecom Approval C84/37/1135

Inc. phone, only **\$399**



### MINI MODEM

- ★ 300 baud full duplex
- ★ Answer originate
- ★ Plugs straight in (hardwired phone)
- ★ Superior VLSI chip performance (identical to Multi Modem)
- ★ Telecom Approval (C84/37/1173)

Incl. phone only **\$199**



### VERBATIM DISKS

"Lowest" price possible for "Highest" quality.

	1-9	10+	100+
MD525-01	3.95	2.75	2.50
MD550-01	4.50	3.95	3.75
VALUE LIFE box of 10	\$22.95		

★ ★ ★ ★ ★ ★ ★ ★ ★ ★

### IBM COMPATIBLE COMPUTER

**\$2,150**

Including tax!

★ ★ ★ ★ ★ ★ ★ ★ ★ ★

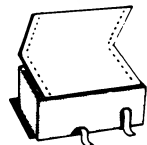

### COMPUTER PAPER

Top quality at a very affordable price. Blank 11x9 1/2", 2,000 sheet, quality 60gsm bond paper

Cat C21001 **\$29.50**



### RITRON (ZETA) DATASETTE

For data loading and saving, this Micron Datasette suits most home computers and features tape counter, monitor function for audio verification and slide volume control for output level.

Cat. C14300 **\$29.95**

## PRINTERS GALORE

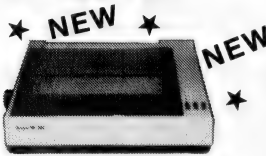

### MB 100S

The next generation of "80" type printers. 100 CPS, internal buffer expandable to 4K, Greek as well as italics. The print quality is the same as its forerunner. Square pins and film ribbon make it unbeatable.

1-4 **\$325** 5+ **\$299**



### ENP1091

The latest addition to our range. Has a near letter quality mode. 120 CPS. Down loadable character set. Graphics, Italics, emphasized etc.

Was \$500 Now **\$420**



### Juki printer

Professional daisy wheel printer 18 CPS full incremental mode Diablo 630 emulation. Large range of daisy wheels. 8K internal buffer available.

Was \$950 Now **\$790**



### Star Gemini 10

120 CPS logic seeking Italics, graphics and down-loadable characters sets. Friction and tractor 9 x 9 matrix. Hi res. graphics. Low cost typewriter ribbon.

Was \$430 Now **\$360**



### Star Gemini 15

120 CPS logic seeking Italics, graphics and down-loadable characters sets. Friction and tractor 9 x 9 matrix. Hi res. graphics. Low cost typewriter ribbon.

Was \$899 Now **\$729**



### Star Radix 15

Excellent fast printer 200 CPS eats up the pages. With an amazing 16K internal buffer you won't waste any time. Has near letter quality mode, graphics, and font variation.

**\$1,395**

## MONITOR MADNESS

COLOUR IS HERE IN A BIG WAY!!



### PHOENIX V

Available late November. Order now for Xmas!

- Pal. Suits Apple, Commodore even your V.C.R.!
- ★ Pal and R.G.B.
- ★ Normal Res.
- ★ 13" CRT Dot Pitch 0.65mm
- ★ Horiz. Resol. 320 TV Lines
- ★ Vert. Resol. 560 TV Lines
- ★ Display Characters 1000 Ch. (40 x 25)
- ★ 16 Colours (Pal)
- ★ Green Text Display

Cat. X14522 **\$449**

### PHOENIX IV

Suits 'IBM' R.G.B. input

Cat. X14520 **\$690**

### RITRON 1



Our most popular model in a steel cabinet to minimise R.F.I. interference. Prices include tax. Make sure you get in early.

1-4 **\$139** 5-9 **\$135** 10+ **\$129**

Cat. X14500 (Green) **\$139** **\$135** **\$129**

Cat. X14500 (Amber) **\$139** **\$135** **\$129**

### RITRON II

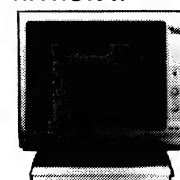

Swivel base monitor in stylish case.

1-9 **\$169** 10+ **\$159**

Cat. X14506 Green **\$169** **\$159**

Cat. X14508 Amber **\$169** **\$159**



### "IBM TYPE" COMPUTER CASING

Give you kit computer a totally professional appearance with one of these 'IBM type' casings. Includes room for 2 5/4 inch disk drives and connection ports. Dimensions: 49x39x15cm.

Cat. X11090 **\$89.00**



### SWIVEL BASE

Makes life easier, normally \$29.50.

Cat. D11100 **\$22.50**

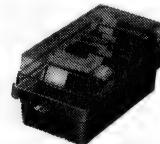

### DISK STORAGE BOXES

25's or 50's

Efficient and practical! Protects your disks from being damaged or lost. Solves all those hassles of finding "that" disk.

Cat. C16025 25 Disk Box **\$29.50**

Cat. C16050 50 Disk Box **\$49.50**

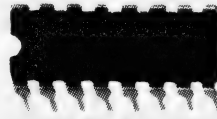

### INCREASE YOUR MEMORY

	1-9	10+
4116	1.80	1.70
4164	4.95	4.50
2716	6.25	5.95
2732	6.25	5.95
2764	8.25	7.95
27128	27.00	25.00
6116	6.95	6.75

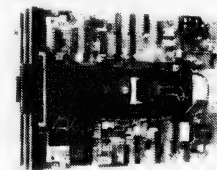

### MITSUBISHI DISK DRIVES

#### M2896-63

Slimline 8" Disk Drive Double sided Density No AC Power required. 3ms track to track, 1.6 Mbytes unformatted, 77 track side 10 bit soft error rate.

Cat. C11916 **\$630**

Case & Power Supply to Suit **\$159**

#### M2894

Standard size 8" drive. Double sided, double density, 96 track/inch, 9621 bit/inch, 1.6 Mbyte unformatted, 3ms track to track access, 77 track/side.

Cat. C11914 **\$630**

Case & Power Supply to Suit **\$89**

#### M4854

Slimline 5 1/4" disk drive. Double sided, double density, 96 track/inch, 9621 bit/inch, 1.6 Mbyte unformatted, 3ms track to track access, 77 track/side.

Cat. 11904 **\$350**

Case & Power Supply to suit. **\$89**

#### M4853

Slimline 5 1/4" disk drive. Double sided, double density, 1 Mbyte unformatted, 3ms track to track, 80 track/side, 5922 bits/inch.

Cat. C11903 **\$260**

#### M4851

Slimline 5 1/4" disk drive. Double sided, double density 500K unformatted, 40 track/side. Steel band drive system.

Cat. C11901 **\$225**

Case & Power Supply to suit. **\$89**

#### M4855

Slimline 5 1/4" disk drive, double sided, double density, 96 track/inch. 2.0 Mbytes unformatted.

Cat. C11905 **\$385**

#### MF353

3 1/2" Standard size disk drive, Double sided, double density, 1 Mbyte unformatted.

Cat. C11923 **\$265**

#### MF351

3 1/2" Standard size disk drive Single sided, double density,

Cat. C11921 **\$225**

# rie

Rod Irving Electronics

425 HIGH STREET, NORTHCOTE VICTORIA  
Ph:(03)489 8866 489 8131  
48-50 A BECKETT STREET, MELBOURNE VICTORIA  
PH:(03)347 9251  
Mail Order and correspondence: P.O. Box 235 NORTHCOTE 3070

### MAIL ORDER HOT LINE



(03) 481 1436



**POSTAGE RATES**

\$1-\$9.99	\$1.50
\$10-\$24.99	\$2.00
\$25-\$49.99	\$3.00
\$50-\$99.99	\$3.50
\$100-\$199	\$5.00
\$200-\$499	\$7.50
\$500 plus	\$10.00

Comet road freight is extra.

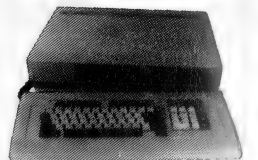

### KEYBOARD AND CASE

Cat. X11080 **\$249**

### REPLACEMENT KEYBOARDS

- For Apple
- 42 single key BASIC command
- One chip custom design encoding
- Made by ALPS, life time "10 million operations"
- Dimension: L340xW110xH42mm

Cat. KC2001 **\$79.50**

- For Apple
- 45 built in function keys. BASIC and CP/M command.
- 45 user defined keys
- Built-in shift lock
- Made by ALPS, life time "10 million operations"
- Dimension: L340xW130xH42mm

Cat. KC2002 **\$99.00**

### ADD ON DISK DRIVES FOR 6502 SYSTEM



1-9 **\$195** 10+ **\$189**

### LINE CONDITIC

Dispose of those clicks and voltage spikes forever. 2 stage output, 2 outlets per stage, rated 1000 W 4A 250V 50Hz. If you want a real computer system, this is for you.

**\$249.00**

Errors and Omissions Excepted



# PORCHESTER Computers

A MULTI-MILLION DOLLAR AUSTRALIAN COMPANY

• MAIL ORDER • PHONE ORDER • CALL-IN

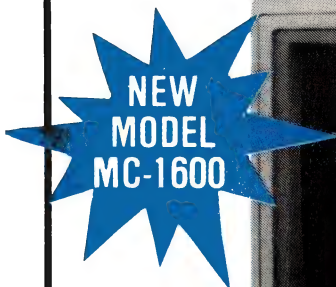

DEALER ENQUIRIES WELCOME

## LOGITEC 16 Bit PC

### BEST FEATURES AND VALUE IN IBM PC COMPATIBILITY

The LOGITEC is a high quality fully-featured 16 bit computer which runs the IBM PC compatible operating systems, and applications software.

We have run a wide range of compatible software on this system, including the popular Lotus 123, and Flight Simulator and it all runs perfectly. Network (optional) hardware and software also runs on this incredible packaged system so that you can cope with that multi-user requirement.

### INCLUDED STANDARD WITH LOGITEC

- PC DOS operating system
- 256K RAM
- RS-232 port
- Centronics Parallel port
- Real Time Clock
- RGB color 80 x 25 text  
640 x 200 graphics  
Monochrome output
- 130 watt power supply (with fan)
- 2 Floppy Disk Drives (720 Kb)
- Quality control for 72 hours on every system

### OPTIONS

- XT 10 Mb Hard Disk
- Network
- Hi-res Color and Monochrome monitors
- MSDOS and CPM-86

## LOGITEC from KANTO DENSHI CORPORATION

PC-1600 dual floppy system

**\$2995** inc  
\$2595 ex

XT-1600 10 Mb hard disk system

**\$4995** inc  
\$4325 ex

PORCHESTER provides technical advice and consulting on all aspects of your business requirements. Specialised software is available for Real Estate, Insurance Broking, Accounting, Word Processing etc. Call in or phone!

## \*\*\*\*\* XMAS SPECIAL! \*\*\*\*\*

The EXECUTIVE 816 PORTABLE only **\$2995** inc.

Up until 24th December you can buy this complete business system for this very special price.

The EXECUTIVE 816 in either 1.6 mB or optional 10 mB is a powerful business system and comes to you complete with a large range of ready-to-run business software including: Debtors, stock control, creditors, general ledger word processing, database, mail merging, supercalc spreadsheet, membership, office costing, job costing, & communications.

The standard 816 has twin floppy disk drives with a large 1.6 Mbytes AND NOW!

The 816-10 has a full 10 Megabytes Hard Disk PLUS an 800K floppy . . .

**COMPLETE WITH SOFTWARE AND TRAINING!**

**DESK TOP MODEL only \$3555 inc.**



**1.6 MB TWIN FLOPPY AND 10 MB HARD DISK AND NEW DESK-TOP MODELS**



EXECUTIVE 816 BUSINESS DESK-TOP AND PORTABLES



# PORCHESTER Computers

DELIVERY AUSTRALIA WIDE

• MAIL ORDER • PHONE ORDER • CALL-IN

## LOGITEC FT-5002/120 PRINTER

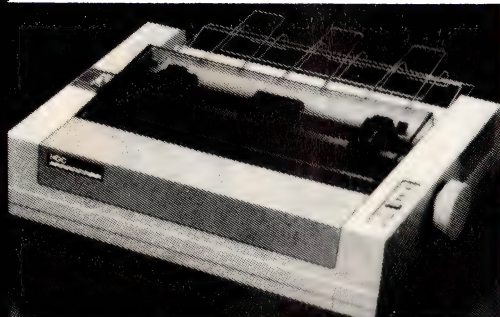

Note: Some people have been selling this printer for \$490, and even over \$500. We import direct, so we sell it for \$409...

**\$409 inc**

\$375 ex

### NEW MODEL

**OUR INSTANT BEST SELLER... with NLQ**

NLQ means Near Letter Quality, almost the same as a Daisywheel. Seeing is believing with this printer. Also: 120 CPS, Epson MX80 compatible, IBM matrix and graphics compatible, 1.6K buffer, proportional spacing, 10 pitch, 12 pitch, fabric or carbon ribbons.

## NEW MODEL! 100 DT PRINTER.

Many more features than 80DT/BX80! Now has 100 CPS, 10 Pitch, 12 Pitch, Proportional Spacing, 8 Character Sets, etc., etc.

**\$325 inc.**  
**\$289 ex.**



We supply cables and interfaces to suit most micros!

**XMAS SPECIAL FOR COMMODORE 64.**  
Xetec Interface and 100 DT Printer. Together for only **\$399 inc.**

## TWO GREAT HIGH QUALITY MONITORS!

**HI-RES AMBER & GREEN**

**VERY HI-RES AMBER**



20MHz

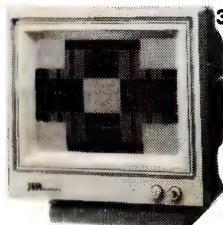

30MHz

... for Apple, Microbee, Executive, Kaypro, Osborne, etc.

... for IBM PC/XT, Tilt/Swivel IBM Connec.

**\$149 inc. XMAS SPECIALS \$249 inc.**

## DISC DRIVES

**ATLAS 8 FOR YOUR APPLE**

**\$245 inc.**  
**\$209 ex.**

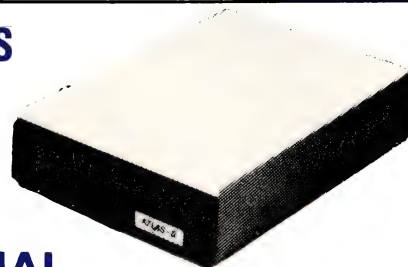

## NATIONAL

FOR: IBM PC, Challenger, Columbia, Tandy, Eagle, Kaypro, Osborne, etc.

FOR: Apricot, Excalibur, Executive, Kaypro 4, etc.

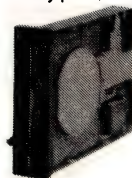

40 TK DSDD  
**\$219 ex.**



80 TK DSDD  
**\$239 ex.**

## IC's TO SAVE YOU MONEY!!

**2764 EPROMS**  
**\$5.90 ex.**

**6164 RAM**  
**\$8.50 ex**

**IBM 64K PAK**  
**\$75 ex**

### • LOWEST PRICES

### • FAST DELIVERY

First Floor  
169 Victoria Parade,  
Fitzroy, Vic 3065

Both locations open:  
10-6 Weekdays  
9-1 Saturday

Also NOW at:  
**68 Punt Road,**  
**Windsor, Vic 3181**  
(NEAR ST. KILDA JUNCTION)

**(03) 417 6999 (03) 51 7647**

MAIL ORDERS • Send Cheque/Postal Order, or Bankcard details. PHONE ORDERS to above numbers.

**6 MONTHS WARRANTY ON ALL PRODUCTS**



**DEALER ENQUIRIES WELCOME**

# ANZ computer books

Australia & New Zealand Book Co. Pty. Ltd.

Your first source of information

## 6 Great Books from Australia's Leading Computer Book Distributor

### MASTERING SYMPHONY

by Doug Cobb

(SYBEX) (PB) \$49.95

This book will be readily understood by those who have had no experience with Symphony or 1-2-3. For those who are upgrading from 1-2-3 to Symphony, highlighted sections describe the differences between the two programs. Topics covered include – spreadsheets; database management; word processing; graphics; communications; and the command language. Important tips on how to integrate the various functions are carefully detailed. The book is packed with examples and practical applications business users need!

### UNDERSTANDING dBASE II

(SYBEX) (PB) \$39.95

Learn programming techniques for mailing label systems, bookkeeping and data base management, as well as ways to interface dBASE II with other software systems. Helpful for the advanced user, as well as the beginner.

### SIMPLY dBASE II

(SYBEX) (PB) \$19.95

A simple, easy-to-follow guide that shows how to get going with this popular database management program. It explains what you do, how you do it, and why you do it.



### REAL WORLD UNIX

(SYBEX) (PB) \$32.95

Written in a practical, straightforward manner for the beginning business user of the Unix operating system (Version 7). All the commonly used commands and their options are explained and illustrated, and a sampling of Unix-compatible hardware and software is reviewed. A comprehensive command summary and listing of Unix resources is also included.

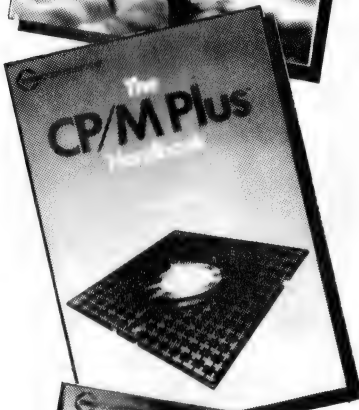

### CP/M PLUS HANDBOOK

(SYBEX) (PB) \$39.95

This guide is easy for the beginner to understand, yet contains information for advanced users of CP/M Plus (Version 3). Built-in and transient commands and the file-transfer and system editor operations are described in detail, along with many practical hints for using a CP/M Plus computer.

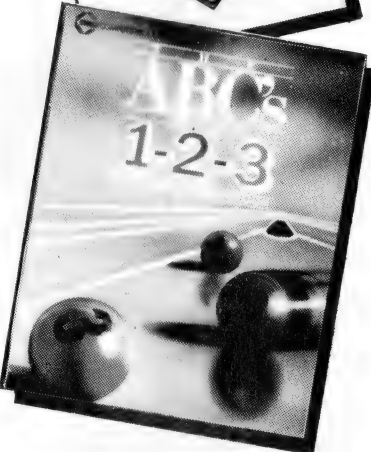

### THE ABC's OF 1-2-3

(SYBEX) (PB) \$24.95

For those new to the LOTUS 1-2-3 program, this book offers step-by-step instructions in mastering its spreadsheet, data base, and graphing capabilities. Also included is a resource guide to integrated software.

These books are available at bookstores and computer stores everywhere but if you experience difficulty OR if you wish to receive regular information on new books, contact the distributor, ANZ BOOK CO., 10 Aquatic Drive, Frenchs Forest 2086. (02) 452-4411.

# MSX MISSILE LAUNCHED

MSX IS THE new pan-Japanese standard for home computers, which aims to provide complete compatibility among different manufacturers' products. The promise is that machines and peripherals from such Japanese big-name manufacturers as Canon, Sony, Hitachi and Yamaha will all connect with one another. Common software will come from a variety of sources – in the first instance Microsoft, whose president Bill Gates is said to be very keen on MSX. In Britain, 45 software developers are compiling lists of up to 15 MSX software titles. Among them is the highly respected Psion, who wrote the applications packages which accompany the new Sinclair QL.

That's a lot of job opportunities for talented programmers – and not just of games. This is welcome news in the UK, where times are getting tough for games software houses. Industry analysts are scaling down their predictions of sales in 1984, and there have been several spectacular bankruptcies – the most notable being Imagine Software, the brash Liverpool firm which crashed amid bitter recrimination among its directors and pending police charges. Dragon Data, manufacturer of the Dragon micro, recently collapsed too, and Oric has withdrawn all home-market advertising. The promised crock of gold, it appears, is not so easily found.

The most attractive aspects of the MSX computer are its sound and graphics, thanks to the latest dedicated sound and video display processor chips. It will operate or control other electronic equipment with microprocessors – such as synthesisers, musical keyboards, videodiscs and cassettes. It also

Various examples of portable computers based on Japan Inc's MSX standard.



*The MSX computer standard from Japan has been created with the aim of finally providing compatibility between computers and peripherals from different manufacturers. Our correspondent in the UK, Martin Hayman, reports on the launch in Europe of the first machines using the standard.*

opens up the way to a universal brotherhood of communication among people, all equipped with their own little MSX micro, sending each other their thoughts and messages, music and pictures; as Kay Nishi, Microsoft's vice-president of future developments, put it: "It will make people happy."

But it could be bad news for British and perhaps even American manufacturers, who have so far had

little to fear from the Japanese. Now that consumers see on home computers the names which are already familiar to them on stereos, cameras, guitars and video recorders, they might turn to them in preference to the British and US names which until now have pretty much had the home computer scene to themselves. The UK was the first market outside Japan to get MSX computers – Toshiba's was the

# RIGHT PRICE. RIGHT SIZE. RIGHT SPEED. *That's Riteman!*



*If you're looking for an Epson\* or IBM\*\* compatible dot matrix impact printer that's lower in price, smaller, durable, and fast enough to keep pace with your work flow . . . we'd like to show you a Riteman!*

*Four great new printers. All priced well against comparable Epson models. All substantially smaller. Yet solid as a rock. With print speeds up to 50% faster than the competitors.*

*The Riteman Plus, Riteman II, Riteman 15, and Riteman Blue Plus with IBM graphics. All are backed by a full one-year warranty. And, as you can see, they're great-looking, too!*

**For further information contact your local Riteman dealer, or Warburton Franki**

\* Epson is a registered trademark of Epson America, Inc.  
\*\* IBM is a registered trademark of International Business Machines Corp.

## **RITEMAN:**

**Distributed exclusively in Australia by:-**



# **Warburton Franki**

A DIVISION OF THE ANI CORPORATION LTD (INCORPORATED IN N.S.W.)  
 ● ADELAIDE (08) 356-7333 ● BRISBANE (07) 277-0222 ● HOBART (002) 28-0321  
 ● MELBOURNE (03) 795-9011 ● PERTH (09) 277-7000 ● SYDNEY (02) 648-1711  
 ● AUCKLAND N.Z. (09) 50-4458 ● WELLINGTON N.Z. (04) 69-3016

WF936/81



The Sinclair QL – beset with problems from the start, it hasn't done much for Sinclair's reputation.

first machine to arrive, closely followed by Sanyo, Sony and Canon. The Japanese are likely to avoid taking on the US, at least immediately, and if MSX goes well in the traditional stronghold of Sinclair and Commodore those companies could also find themselves threatened in their export territories like Australasia.

### Sinclair Threatened Too

Not even the mighty Sinclair is immune to the threat of being overshadowed by the Japanese, it seems. Psion Software's boss David Potter endorsed MSX as a software exporting possibility – and his firm Psion developed for Sinclair the suite of applications programs which accompany the QL (see *Your Computer*, October 1984, for a review of the QL). The QL has got off to a difficult start, with the delivery delays customers have come to expect of Sinclair. Orders placed at the time of launch were not delivered to customers for three months, and this has hurt the company's reputation.

It also means that few people have yet got to grips with the Psion applications programs Abacus (spreadsheet), Archive (database), Easel (graphics) and Quill (word processing). If Psion throws its weight behind MSX, it can hardly go on working with Sinclair. If 45 other UK software houses went over to MSX, following Psion's lead, Japan could just about be pulling the plug on the UK home computer operation.

Sinclair and Acorn have been

locked in a duel over trying to export to India and China, but Sir Clive seemed ready to conquer the world when he announced the QL (early in 1984) for delivery soon. At the price, and with the quality of the four software packages bundled with it, it seemed incredible – and it was. Alas, it was the same old story as the Spectrum. Customers liked the sound of it, and sent away their money, only to find that the production versions were not quite ready; and people started counting how much the interest on their money was worth before getting the product in their hands.

This time the customers may prefer not to wait for delivery and cancel their cheques first. Nigel Searle, Sinclair's chief of computer division, admitted recently that the customers who waited a year before buying their Spectrums got a better machine. The first batch of QLs went out with an extra ROM jammed into the back of the machine in order to accommodate the overflowing SuperBASIC. Sinclair's credibility has taken a knock; the public has been complaining that Sinclair did not keep his promises – that you paid your money, not for a machine, but for a place in the queue. But the Sinclair QL for all its teething problems is bristling with new features, and it is the first computer to use the Motorola 68008 processor. The Japanese MSX standard offers little that is new: the Z-80A processor at the heart of the system has been around a long time.

Microsoft UK boss David Fraser defends the use of the Z-80 CPU, saying at the launch: "It's not old, it's just not new." There is a wealth of software for the Z-80 and probably more people know how to program in Assembler on this CPU than any other. MSX is said to be 'functionally compatible' with CP/M, although Microsoft obviously did not go out of its way to publicise this.

### Compatible Operating System

Microsoft people are much keener to show that the disk operating system, MSX-DOS, is format-compatible with MS-DOS – and, later, with Xenix, Microsoft's version of Bell Laboratories' Unix operating system. The possibility of exchanging data disks among home, personal and professional multi-user computers is one that seems to have been overlooked by some UK commentators, who think the MSX standard will be short-lived, even to the extent of asking whether the standard has a 'use-by' date. MSX will in due course have Sony-standard 9 cm microfloppies, which for worldwide sales look more promising than Sinclair's proprietary Microdrive cartridges.

Further, according to Microsoft, the Z-80 CPU's life is extended by its association with the two other chips in the MSX spec, the Texas Instruments Video Display Processor (VDP) and the Sound Generator. Extensive commands are available in the BASIC to call procedures from these processors. MSX BASIC is said to be 95-97 per cent compatible with IBM BASICA, and because graphics and sound are handled outside the CPU, there is 60K user memory area (none of the user memory is taken up with the video map). Texas Instruments, which gave its own presentation at the launch, said there would be improved versions of the video chip which would slot into the MSX spec with no compatibility problems. Different versions of the chip are used for different TV standards, but this does not affect the MSX ROM, according to Texas.

### Rising Star

Kay Nishi, who devised the MSX standard, is the rising star of Microsoft. The story goes that he was an agent



commercial and professional microsystems

9th Floor, 505 St Kilda Road, Melbourne 3004, Aust.

Telephone (03) 267 7829

## C.P.M. MINI CONQUEROR THE COMPLETE DESKTOP SOLUTION — POWERFUL, EASY-TO-USE, FRIENDLY, RELIABLE

### COMPRISING:

- 12in green screen terminal, on swivel base with detachable keyboard. 95 keys, separate numeric key pad, 10 function keys, built-in graphics capability.
- Z80A running at 4MHz
- 64K bytes of RAM, 4K bytes of ROM.
- 1—Centronics port.
- 2 RS232 serial ports. Software selectable baud

rates to 38.4K baud

- Mass storage: two double sided, 80 track disk drives, 800K bytes (formatted) per diskette 1.6M-bytes total internal storage.
- CP/M 2.2 with enhanced BIOS & CCP.
- Integrated accounting software: General Ledger, Accounts Receivable, Accounts Payable, Stock Control & Invoicing.
- Reads/writes other popular computer formats

**OPTIONAL:** (1) T Maker III software \$365.00\*\*, wordprocessor/spreadsheet/database management/ bar charting (2) Friendly — operating system overlay — \$79.00\*\*. (You won't have to learn how to use CP/M

**SPECIALISED BUSINESS SOFTWARE:** For nearly all fields, e.g., motel, insurance, real estate, medical/dental, farming, video shops, etc., etc., also available.

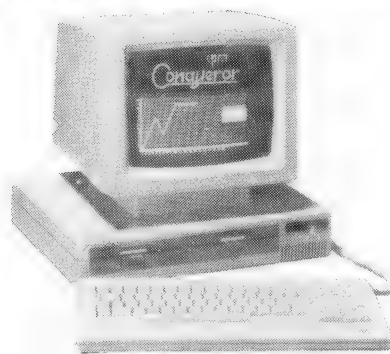

**STOP PRESS**

WE NOW INCLUDE THE FOLLOWING SOFTWARE  
★ WORDSTAR ★ MAILMERGE ★  
★ CALCSTAR ★  
★ DATASTAR ★ REPORTSTAR ★

CALL US FOR SPECIAL INTRODUCTORY PRICE

### SOFTWARE AUTHORS/DEVELOPERS & DEALERS

At last a computer that lets you read/write/format virtually all soft-sectored CP/M formats, whether single or double density, single or double sided, 5" or 8", 48 TPI or 96 TPI.

**INCLUDES:** • Z80A at 4MHz.

- 2 serial ports for printer/modem/ & terminal.
- 1 5 1/4" DSDD 40 track 48 TPI drive.
- 2 5 1/4" DSDD 80 track 96 TPI drive.
- 1 8" DSDD 77 track drive.
- CP/M 2.2 & all disk format conversion software and utilities.

**ALSO AVAILABLE:** 16-bit computer (IBM PC compatible) for format conversion, or buy software separately, see details in this ad.

### COMPUTER MEDIA TRANSCRIPTION/COPYING

- Software duplication, copying and formatting for virtually all popular computers.
- Downloading 8" CP/M formats to over 60 5 1/4" CP/M formats.
- Conversion and downloading from CP/M to MS-DOS/PC-DOS.
- Copy protection for most popular formats.
- Rapid turn around.
- Reasonable charges

### SPECIAL IBM PC (AND COMPATIBLES) UTILITIES

- OPERATING SYSTEM CONVERTERS: • DATA/TEXT FILE CONVERSION:

# SUPER COMPUTER BOOKS

## DYNAMIC GAMES FOR THE AMSTRAD

Clive Gifford

Fifty fast-moving, professionally created games for the Amstrad are waiting for you in this book. Each game has been created specifically for the Amstrad and makes the most of the computer's dramatic colour and sound possibilities.

ISBN 0947695168 rrp \$18.95

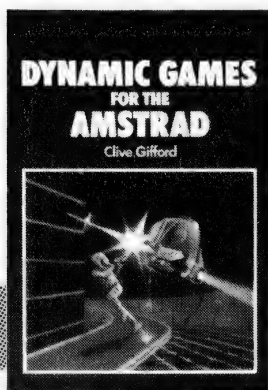

## THE AMSTRAD GAMES BOOK

Mark Ramshaw

A collection of exciting games for your Amstrad, including arcade-style space and combat games, maze games, impossible and dangerous missions for superheroes and many more.

ISBN 0273022849 rrp \$14.95

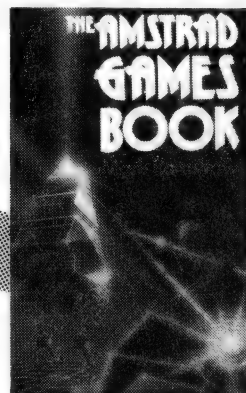

## The Working Commodore 64

David Lawrence

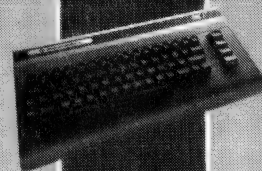

A library of practical subroutines and programs

## THE WORKING COMMODORE 64

David Lawrence

Based on a collection of solid, sophisticated programs in areas such as data storage, finance, graphics, household management, education and games of skill. The programs have been designed to make the most of the CBM 64's special features.

ISBN 0946408025 rrp \$19.95

**PITMAN**

CONTACT PITMAN FOR YOUR FREE COMPUTER CATALOGUE  
(03) 347 3055, (02) 267 1477, (07) 229 5700

for Microsoft products with his firm ASCII. One day on a flight, he sat next to the president of the manufacturing corporation Kyocera and dreamed up the idea of a lap-held portable to a common standard. Out of this came the Tandy Model 100, the NEC PC 8201, the Olivetti M10 and the latest Epson PX-8; these are now the machines which journalists and executives are buying to carry around with them. As part of the spec for these lap-held portables, Nishi sold the manufacturers Microsoft's operating system and BASIC. Now he is doing the same for the home computer market.

Nishi, however, is a visionary rather than a salesman for Microsoft products. Accordingly his talk at the MSX launch was philosophical. He identified three categories of help from a computer: processing numeric data, working with text, and now images and sound. As the car extended the range of the human legs, so did the TV and telephone extend the eyes and ears, said Nishi. Now the robot and the computer would extend the human hand and brain. The computer extends and improves human memory, editing and communication, making itself a powerful tool to handle creativity – which could not come out of a machine alone. Above all it would help people communicate their thoughts and ideas to each other.

In other words, MSX takes the home computer into a new area of real-world applications. By standardising hardware, right down to common plug sizes and pin connections, and providing a common base of software from major software houses, MSX will allow ambitious programmers to combine computing with other creative hobbies. JVC's version can be used as a videodisc controller. Sanyo's Wavy 10 has a 'frame grabber' which will capture images from TV, videotape or videodisc, digitise them and dump them onto computer disk. They can be called back and manipulated, or overlaid with computer-generated graphics. Yamaha's selling point is a bolt-on DX-7 synthesiser board with MIDI interface to musical keyboards. Other desirable peripherals such as disks, printers, plotters, lightpens, joysticks, trackballs and so on are already available.

### Products for a Mass Market

"What can I do with my computer?" is a question which can now more easily be answered by another question: "What can I buy for it?" Herein lies the true reason for MSX. It is a standard which has been sold to the Japanese leisure and entertainment corporations as a way of selling more electronics products. The home entertainment centre offers almost limitless prospects to those who can supply the right peripherals. Canon, Sony and the rest are certainly able to supply such items from their Far Eastern factories. Because MSX offers them an opportunity to tie all these devices together and make them more useful – and therefore more attractive to the consumer – the big-league Japanese manufacturers are all backing the standard.

Nishi's dream seems to be to link the MSX machine with any kind of appliance in the home which contains microprocessor intelligence – washing machine, TV, hifi, whatever. "The measure of prestige in the home seems to be how many remote controls you have. People are beginning to have trouble with which controller to pick up. We need something to integrate all this intelligent home equipment," he says.

Control of all home appliances has long been a dream of microcomputer enthusiasts, but here the MSX standard may not be as much of a breakthrough as we had hoped. Nishi mentioned home control as an application, and suggested that the CPU would link with microprocessors already installed in household appliances like TVs, videos and so forth. This is all very well, but so far MSX provides only for RS232 communications. Communications software between MSX and external micros has not yet been written, and Nishi refers to it only as a "future enhancement".

Furthermore, by its very nature household control is a variety of different jobs which need doing, with different devices, in real time. The Z-80A is unsuitable for this without resorting to bank-switching. This is not likely to be attractive to people who just want a computer to make running the home as easy as possible. Nishi hinted that a next-generation

MSX based on 8086 might have such communications protocols written into the spec – though Microsoft might not be too keen on this since it offers a way in for Digital Research, whose Concurrent CP/M now looks exactly like MS-DOS. Nishi's suggestion is puzzling, because Bill Gates has said that he expects a next-generation MSX would be based not on the Intel 8086/8 but on the Zilog Z-8000, which obviously makes better sense.

But these are considerations for the future. What the British home computer industry sees right now is Japan Inc aiming to take over the home computer market. Up till now, the Japanese have got their marketing in Britain wrong. Now they have the right products and are getting ready to market them like cameras, hifi and calculators. The manufacturers dream of another Sony Walkman-type success, where the brand name (Walkman) has come to define the product type (personal cassette stereos). Even the new generation of lap-held portables, which are truly machines for business people, are packaged just like the Walkman – and it is a sign of the times that when Apple wanted to redesign the IIe into the compact IIc version, it went to Frog Design, the creator of the Walkman. Apple expects to get a lot more life out of its old-technology II by repackaging it; so despite the criticisms of the MSX standard for being 'old-fashioned', this is likely to be only a minor point with buyers. And there's no doubt that the MSX micros have the indefinable air of mass-production quality which the Japanese have made their own.

What the MSX computers will do is take a lot of the headache out of linking up a micro system, and make new sales opportunities for the Japanese. Undoubtedly, too, they will be cheap – around \$400-\$500. The low cost of disks, printers, plotters and the like will be a strong argument among buyers to go for the label 'MSX'. This may not be enough in Britain, which is the maturest home computer market in the world, but if the Japanese can crack the UK with MSX then they have a good springboard for the rest of the world (with the probable exception of the US). UK manufacturers are hoping they won't; they have enough worries of their own.



It's mouthwatering. 64K of RAM, 32K of ROM, a high resolution green screen VDU, integral cassette data recorder, typewriter style keyboard, numeric keypad and a very fast extended BASIC.

The CPC464 is also available with a

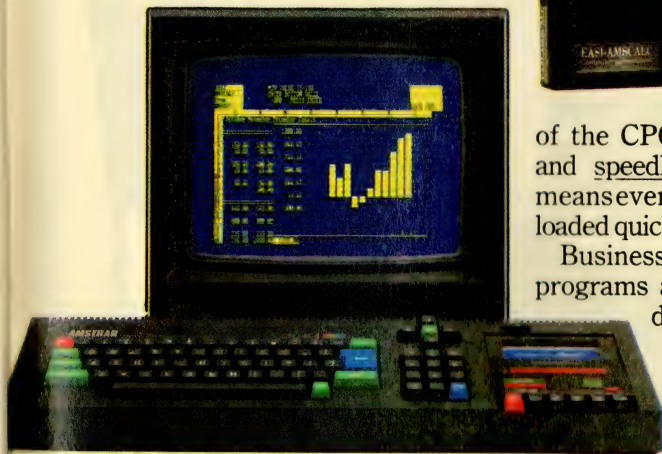

CPC464 colour monitor (CTM640)

colour monitor instead of the green screen VDU.

You'd be hard pressed to find a comparable computer for the money let alone the monitor and recorder.

And the CPC464 comes complete and ready-to-go. Just plug it in.

**64K RAM (42K available).**

The low cost but powerful CPC464 is equally at home in business and educational applications as it is running the household budget or playing games.

With 42K RAM available to BASIC, the opportunities for sophisticated and complex programming are considerable.

**80 column text display.**

The green screen VDU is purpose designed with a bright, crisp, 80 column text display that compares favourably with systems costing several times as much.

You can program up to 8 text windows and there's a graphics window, too.

The CPC464 has a typewriter style keyboard, large ENTRY key, sensibly positioned cursor keys, numeric keypad for fast data entry and a full 8-bit character set.

If you think that sounds impressive, wait until you hear the 3-voice, 7-octave stereo output through a hi-fi amplifier and speakers.

**Amsoft. High quality software.**

A wide range of programs is already available and we're expanding it rapidly. The software takes full advantage



of the CPC464's high specification and speedloading capability. Which means even complex programs can be loaded quickly.

Business applications, educational programs and arcade games are all designed to make maximum use of CPC464's impressive graphics, stereo sound and processing abilities.

**Amstrad. User Information Service.**

Whether you're interested in serious commercial applications or you're a games fanatic you'll want to receive the latest information about your AMSTRAD Computer. Upon request you will be advised about the latest software and its application, special information concerning your CPC464, available peripherals and software reviews. There will also be programs and exercises to try.

In addition to the User Information Service you will be given details

of where you may contact your nearest independent user club.

**CPC464. Unlimited scope for expansion.**

We've thought of everything you're likely to need in the future. That's why there's a built-in parallel printer interface. A low cost optional disk drive system including CP/M\* (with the option to access 3000 programs) and LOGO. Joystick port. And the virtually unlimited potential of the Z80 data bus with sideways ROM support.

Finally, a power supply and modulator (MP-1) allows you to connect your CPC464 green screen VDU system to a colour TV.



Optional disk drive DDI-1 including interface CP/M\* and LOGO



Optional 80 column dot matrix printer DMP-1 operates at up to 50 characters per second. Combined with the CPC464, it offers a high performance text processing system.

Distributed and guaranteed throughout Australia by:

**AWA-THORN AMSTRAD**

\*Trade mark Digital Research

I'd like to know more about the incredible CPC464 complete computer system and where to see one. Please send literature right away.

NAME \_\_\_\_\_  
ADDRESS \_\_\_\_\_  
POSTCODE \_\_\_\_\_

To: AWA-THORN Consumer Products Pty. Ltd.,  
348 Victoria Road, Rydalmere, N.S.W. 2116.



CODE NO: TPB 184

# 3.5" DRIVE FOR THE APPLE II

- ★ Twice the memory capacity of standard Apple drives
- ★ Uses standard Apple controller card
- ★ Ultra reliable 3.5" medium



**\$420**  
inc S.T.

## Australian Video Presentations

325 Bank Street, South Melbourne 3205 (03) 699-4177

# C.A.E. ELECTRONICS PTY. LTD.

SYDNEY'S LEADING EPSON COMPUTER DEALER

For solutions to your Small Business problems, talk to the professionals at CAE for expert advice on the BEST Hardware & Software in the industry.



# EPSON QX-10

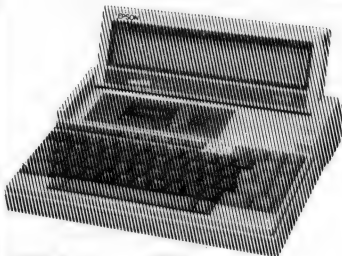

**PX-8**

**\$1235**  
(\*ex. Tax)



Prices for the QX-10 start at **\$2500** (\*ex. Tax). A full range of peripherals is available including 10-40 mB Winchester disks, Local Area Networking, IEEE 488, Optical fibre communications, A/D & D/A converter, and Much More.

RS 232C Port : Light pen interface  
Centronics parallel port  
Colour option available  
S-slot expansion bus  
Fast voice coil motor disk drives

256 K RAM : 2 x 320K drives  
640 x 400 dot graphics  
Real-time clock & calendar  
2 x RAM drives : Battery backup  
16 character fonts

**We offer the BEST After Sales Support possible.**

**1/27 FORGE STREET, BLACKTOWN, (02) 621-4242**  
**P.O. Box 62, BLACKTOWN, NSW 2148 (02) 671-6951**

*Computers, peripherals and software arrive at this office rather like confetti at a wedding, and, while most of them are interesting, we and our reviewers simply don't have the time to do a full review of all of them. To try and remedy this situation, we're planning to run regular 'overview' articles about these products in order at least to give readers an idea of what they do and their good and bad points.*

# The BIT BUCKET

By Evan McHugh

## **Microkits**

WE'VE BEEN getting pretty paranoid about dirt here at *Your Computer* over the last few months. The office has been afflicted by a virulent strain of builders causing storms of concrete dust, showers of grout and sunbeams of open air, with all the pollution that comes with it. The result has been layer upon layer of muck building up on our equipment in spite of our frantic efforts to get rid of it.

As a result of the need for daily dustings we have been taking to cleaning kits like pigs to truffles. One of these is the Microkit from Richard Foot, which is one of the most complete packages for cleaning microcomputers that we at *Your Computer* have come across.

It comes in a bookshelf-storage case that holds the various cleaning products in moulded plastic compartments. Most of the cleaning products are designed for wiping off dirt, but there are also head cleaners and cotton buds for cleaning almost every part of the computer.

The Safeclens are similar to those little wet paper towels you get at fast

food joints to wipe the cholesterol off your fingers. Here you can use them as 'anti-static screen wipes', and in this role they work very well. They give a good clean surface that is resistant to dust for up to a week – and by 'dust' I mean daily clouds that reduce visibility by 20 per cent.

For bigger jobs there are Foamclene and lint-free wipes. The Foamclene is a bit like shaving cream but leaves an anti-static surface and is good for

cleaning down the outside of your equipment.

Next, there is Safeclene, a clear cleaning fluid for use with the cassette cleaner, disk drive cleaner and cotton wool buds.

The cassette head cleaner is a cassette with a special surface for picking up dirt. You spray some Safeclene onto it through the tape observation vent which has been left open, then put it into your cassette

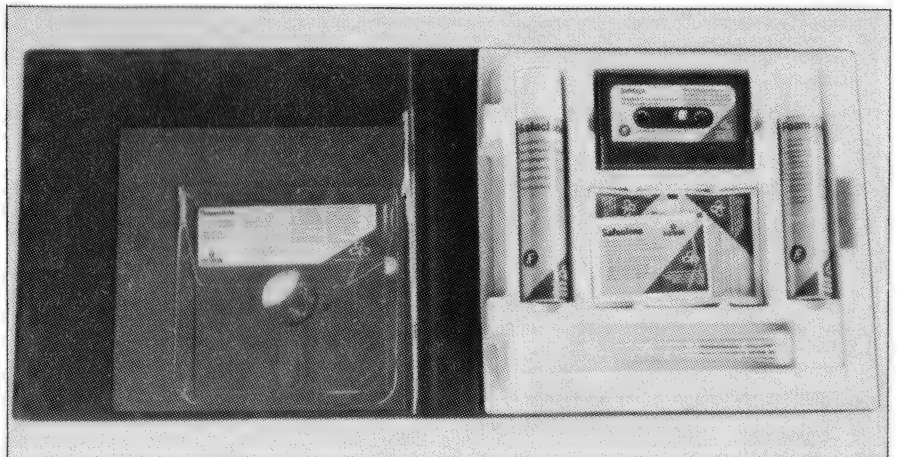

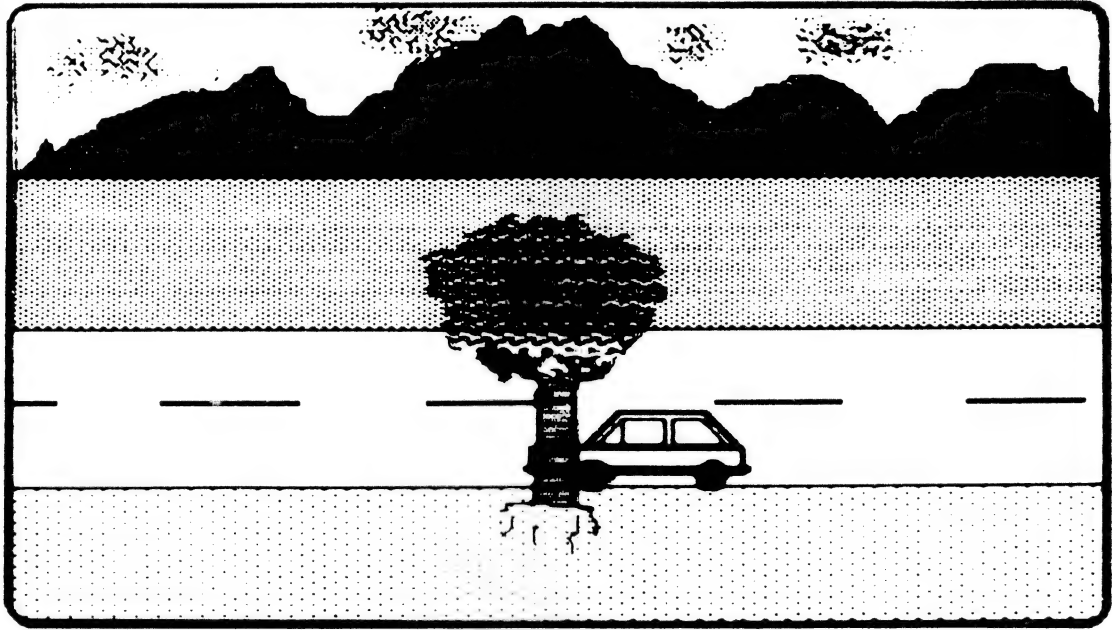

**PLANE 1** [REDACTED]  
[REDACTED]

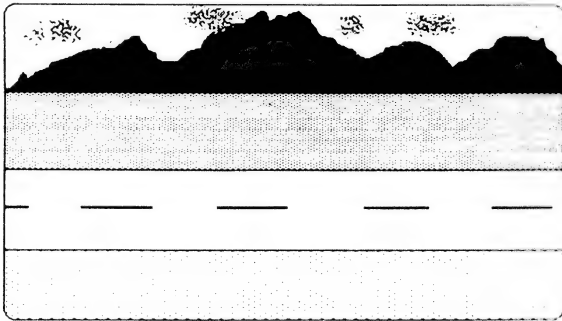

**PATTERN PLANE**

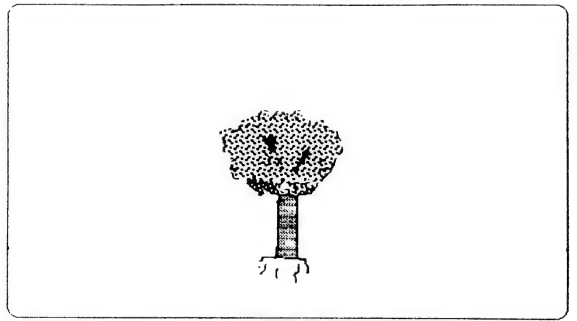

**PLANE 1** [REDACTED]  
[REDACTED]

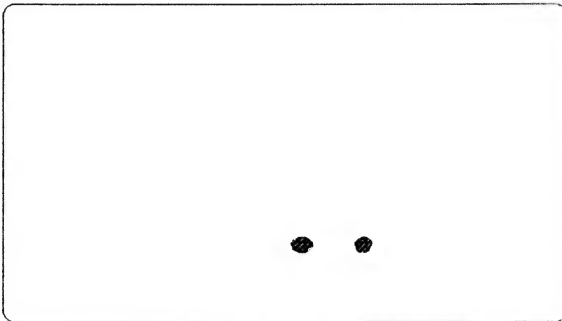

**PLANE 2** [REDACTED]  
[REDACTED]

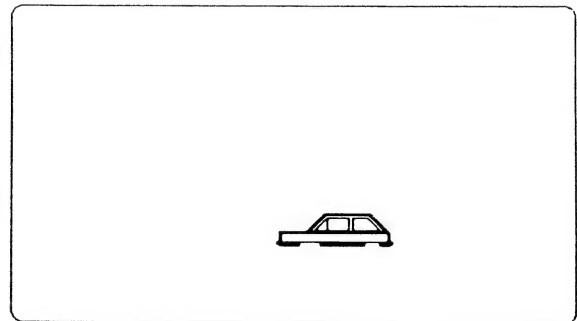

**PLANE 3**  
[REDACTED]

◀ **The Apple Sprites Card lets you create the designs you want, edit them and then put them all together.**

player or datasette, and press play.

The disk drive cleaners are another proposition. Here there is a rubber glove supplied with a diskette sleeve and ten diskette cleaners. You spray some Safeclene onto the lint-free cleaners, slide them into the diskette sleeve and put them into the disk drive – and then you have to come up with some way to get the head to engage with the disk. An attempt at a directory read usually does the trick. The rubber glove is used when handling the cleaners so you don't put any finger grease or dirt on them.

Finally, there are the cotton wool buds. These have extra long sticks so you can poke around the innards of printers, disk drives and the computer, cleaning up pieces of dirt beyond the reach of mortal fingers.

In the kit you get one bottle of Foamclene and a bottle of Safeclene. These are the chemical elements which, while they have no instructions regarding toxicity, do have instructions about flammability. It would probably be best not to drink or sniff these products. You get about twenty cotton wool buds, ten lint-free wipers and ten Safeclens. There is one cassette cleaner and ten 13 cm disk drive cleaners.

The whole lot costs \$43.45. For an extra \$39.60 you can get Floppyclene kits for 13 cm and 20 cm drives, which contain 20 drive cleaners each.

When I spoke with the distributor at the time of writing, the refill position was still not settled, but in the near future replacements for all the products in the kit will be available.

Distribution is currently being expanded but you should be able to get Microkits from most computer suppliers. If you have any trouble you can contact the distributor, Richard Foot, on (02) 43 0326 for your nearest supplier.

### **Apple Sprites and Graphics**

An Australian firm, Australian Video Presentations, has come out with two new products for the Apple that make the often complex and arduous task of creating graphics on the Apple II a whole lot easier.

The first of these products is hardware based; a card that makes it possible to create and manipulate sprite graphics. The card is designed and manufactured in Australia and,

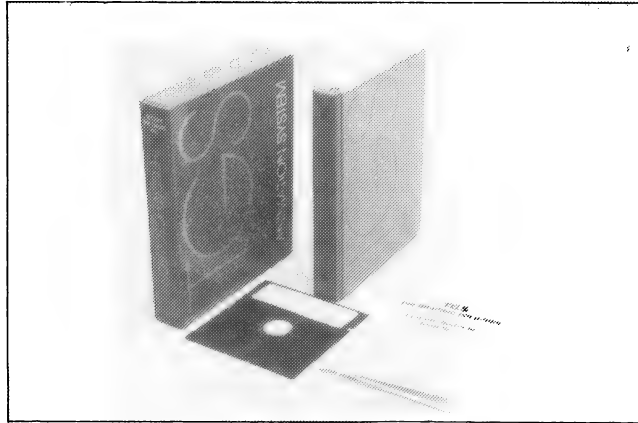

◀ **The Graphics Solution provides impressive results with a minimum of effort.**

while it is not the first such card developed, offers compatibility with Australia's PAL television system, as opposed to the NTSC flavour from the US. The card normally operates through an RGB monitor.

The card lets you set up 31 sprites on a multi-coloured background. Software included with the card makes setting up sprites a simple task, and simple commands let you move and overlay sprites to produce that 'three-dimensional' effect.

Normally, the AVP Sprite Graphics Card plugs into slot 5 of the Apple, but this can be reconfigured to any slot by changing the software. The card is about the same size as a normal 80-column or RGB card.

The complete package contains the card itself, a diskette with the software to drive the card and a cable to connect your 80-column or RGB card to the Sprite Graphics Card from the video-out pins. Video-out is then taken from the Sprite Graphics Card to the monitor. On the card itself there is a switch that lets you switch from the normal video output to the sprite graphics output, a two-screen arrangement.

The software supplied is self-contained, allowing you to create, edit, save and manipulate sprites. It is fully documented with instructions on how to use each utility in the package. Within the program, limited help screens will give you a few prompts as well.

Unfortunately, we didn't get as much time as we would have liked to have a 'hands on' of the package so we weren't able to produce any earth-shattering sprites. The impression

we got, though, was that it was possible to learn how to produce sprites and quite presentable graphics in a relatively short time. It would probably take about four hours to get acquainted with the package and an indefinite period of time, probably the rest of your life, to exploit all its possibilities! The main limitation with this sort of package is not so much the package itself as the skill of the user in producing a desired result.

The Sprite card will be distributed exclusively in Australia by Roland.

The other package from Australian Video Presentations is a US package called The Graphic Solution.

This is a software-based package that lets you produce very high-quality graphics without resorting to programming them yourself. All you have to do is 'draw' the images you want and the computer does the rest. But it doesn't end there – you can also produce animation sequences. By defining a series of shapes and placing them in a sequence it is possible to produce such effects as a person walking, a combustion engine in operation and the Space Shuttle taking off, complete with billowing smoke.

All these effects can be produced under software control. The software lets you create the designs you want, edit them and then put them all together to create what appears like a film. You can link and repeat sequences so that endless action can be produced, as in the case of the combustion engine.

The remarkable thing about the package is its speed. The action of the man walking across the screen

involves a sequence of ten distinct pictures. The action is limited in some respects – it's a little jerky and not highly detailed – but it's still impressive for a machine of the power of the Apple.

The Graphic Solution comes with a comprehensive manual that features descriptions of all the commands and a tutorial that explains the use of all the features of the software. There are two diskettes, each with a copy of the program on one side. On the other side of one diskette is a demo, while the other has files that contain the data required to produce the man and other effects.

Again we did not have as much time to use this package as we would have liked, but were able to form the opinion that it could hold a lot of interest and possibilities for non-experts, enabling them to achieve quite impressive and spectacular results with a minimum of effort and knowledge of computers.

This package is available from Australian Video Presentations, 325-327 Bank Street, South Melbourne, (03) 699 4177. The package will also be available through normal Apple outlets.

The Sprite Graphics Card retails for \$320 and The Graphic Solution for \$220.

### ***dBase Comes to the Silver Screen***

Learning a new package, despite what the marketing executives would like you to believe, is a drag. The manual, usually 300 pages or more, often gets tossed into the back seat while you take the new package out on the open road for a spin.

However, with a package like dBase there is a minimum requirement of knowledge before you can use it to store, manipulate and retrieve data in the form you want.

The dBase video cassette tutorial is a novel approach in teaching those basic computing concepts. It sets out in ten roughly thirty-minute lessons to teach the fundamental concepts of the dBase package. It is more than just a teaching package, though, because it uses video to engage the interest of the viewer and emphasise some features of the package more effectively than other techniques. It also details and gives the background

to the package, its development and the people responsible for it.

The ten lessons follow a logical order, starting with an introduction that gives the background to the package itself and some ideas on how to approach the lessons. Subsequent lessons start you off creating a file, entering data, editing it, changing the file structure, sorting and indexing, searching and reporting.

The actual content of the lessons is not much different from that of other styles of teaching; the difference comes with the medium itself.

Probably the best way to learn a package is to have a professional private tutor sit down and guide you through the necessary concepts. In this tutorial you have something that is almost as good – a highly professional tutor that you can stop when you have a problem, go back and review something, or stop the tape and experiment until you have solved your problem yourself.

The lessons are designed to teach the concepts first with only minor attention to detail. You do see the detail but the emphasis is placed on what is being done, the logical steps required to achieve a desired function, rather than the mechanics of actually doing something. The result is that you can virtually sit back and watch television without being distracted by the need for copious notetaking during a lesson.

This approach is further helped by the way the lessons are structured. They start off giving a quick description of the concepts the lesson will teach, then go into detail for each topic, and finally return to summarise the material that has just been covered and reinforce any key concepts that require special emphasis.

The best features of the package are the two techniques it uses to maintain a high level of stimulus in the viewer. The first of these is a series of interviews with key developers of the package that lets you see the people behind it, hear why the package was developed, how, and with what ultimate aims.

For example, it turns out that the programmer who originally wrote dBase was Wayne Ratliff, who wrote it to keep track of football teams he was following while trying to win

some money on football pools. He ended up being buried under a mountain of paper while he kept tabs on all the teams and finally decided there must be a better way. There was. He started using a computer to ease the burden and the package that grew out of his initial efforts was dBase.

The late George Tate, from Ashton-Tate, describes the program as being like COBOL and BASIC but with a built-in query language for managers and report writers. Its other enhancements are ease of file handling and screen handling.

The second feature that keeps the viewer interested in the video is that the presentation of the lessons is not boring; constant changes of scene keep the mind stimulated. A lot of analogies are drawn, such as the similarity of dBase to a phone directory indexing system, and the analogy goes 'on location' to a telephone booth to make the point. In other instances you are taken to a construction site and to a typical office. The effect of this approach is that the tutorial has an almost documentary flavour at times that keeps up the interest level.

We have dBase in our office and although I had never directly used it I had a rough idea how it worked. This package surprised me because I discovered I knew more about the package than I thought and less than I really should have. It also surprised me because when I sat down with some Coke, a bowl of chips and a notebook for a three-hour session of dBase I expected to be bored by someone raving on about a package that was his pet interest. It turned out the package was his pet interest, but the tutorial was very conscious of its audience and did not wander off into details of the fabulous but rarely used tricks of dBase.

Instead, the video slowly, methodically drew out all the fundamentals in an interesting and informative way. The result? A helpful and entertaining introduction to the basics of dBase. It doesn't teach you everything, but it certainly gives you enough to get started and established in the dBase world.

The dBase video cassette tutorial is available from AID Systems in Gordon NSW and costs around \$80.

## OVERVIEW

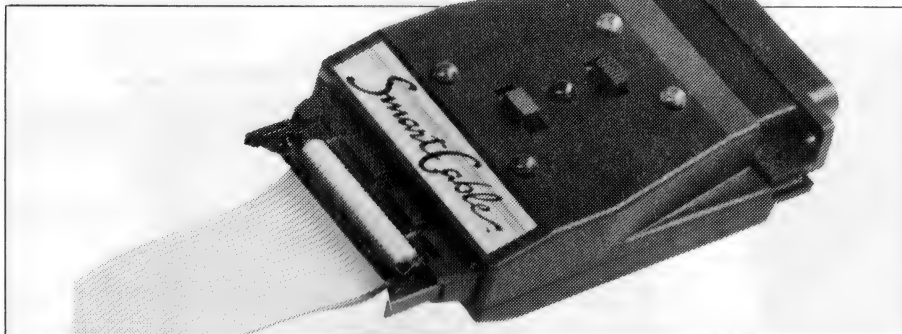

### **RS232 Interfacing without Tears**

It may come as a surprise to computer novices that the standard connection from one 'RS232' device to another is usually anything but standard. What's RS232? What's a standard? What's compatible? You'll probably be asking yourself these questions as soon as you start trying to connect one piece of computer equipment to another. If you're new to computing or haven't had to worry about 'standards' before, you won't know what to do when two RS232 devices won't talk to each other.

This particular detail is often the major source of hassle between you and your dealer and might eventually cost you a big fee to have some technical person work out the correct connection and make up the right sort of cable for you.

A new product on the Australian market should remove much of this particular hassle. Called the Smartcable, this device will connect most RS232 devices to each other so they can transfer data successfully.

The package is designed and marketed for the absolute novice, doing the job that a trained technical person or hacker would take about half an hour to do in about one minute. The package is compact and consists of a very simple pamphlet explaining the use of the equipment, a cable with a 25-pin male and 25-pin female connector on one end and a 26-pin connector on the other, and the logic module (box).

The box is where it all happens. You plug the logic module (described as an SC817) into your computer and the cable from it to the peripheral device. Flick a few switches and

*voila*, it talks. How? Who cares? If you want to know how the connection gets made then you don't need a Smartcable, you need a breakout box or something similar. The Smartcable does all the work for you and lets you get on with using your equipment. The manual tells you how to work the two switches to get the interface going, and that's it.

The Smartcable should be effective in most cases. In those we tried here at *Your Computer* we only had a failure once and that was with a particularly hairy interface between an Olivetti computer and an Admate DP 80 printer. You could expect the interface to work in about 90 per cent of cases, but woe if that other 10 per cent covers your equipment. You will probably have a complex connection that will take a technician quite a struggle to work out.

Unfortunately, there is no list of equipment that the Smartcable will interface. This would be of great help to many people who can't get two machines to talk and would pay any price to be sure of doing so. The Smartcable is not a cheap item. Compared to around \$40 to \$60 dollars for a normal cable the Smartcable costs around \$145, but, for the computer user frustrated when his or her expensive computer won't talk to the equally expensive printer, it may pay for itself again and again.

The Smartcable is available from the distributor, Commandglen, 811 Warringah Road, Forestville 2087, (02) 452 4867.

For people who are not satisfied with the plug 'er in and forget about it approach, check out the book review of *The RS232 Solution*, which appears on Page 94.

## COMPUTER POWER SUPPLY PROBLEMS?

Have you considered  
the Matsunaga  
stabilised A C  
power supply?

Precision manufactured,  
accurate and efficient.  
Matsunaga automatic voltage  
regulators offer rapid voltage  
correction with zero waveform  
distortion. The units are of  
robust, but compact and  
lightweight construction and  
are ideal for applications where  
constant voltage is important.  
Where specific line interference  
problems occur, Electromark  
will supplement the voltage  
regulator with filters selected  
for the particular problem.

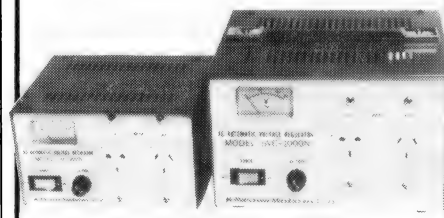

**Models** — SVC, 350 NA  
500 NA, 1000 NA

**Input Voltage** —180V to 260V AC

**Output Voltage** —110V to 240V  
± 3% (simultaneous output)  
Single phase 50-60 Hz

**Prices** 350 VA = \$141.00  
500 VA = \$174.00  
1000 VA = \$252.00  
(plus Sales Tax if applicable)

**Quantity discounts available**

**ELECTROMARK PTY. LTD.**

**43 Anderson Road,  
(PO Box 184)  
Mortdale, NSW 2223**

**(02) 570-7287**

# Starts small, thinks big

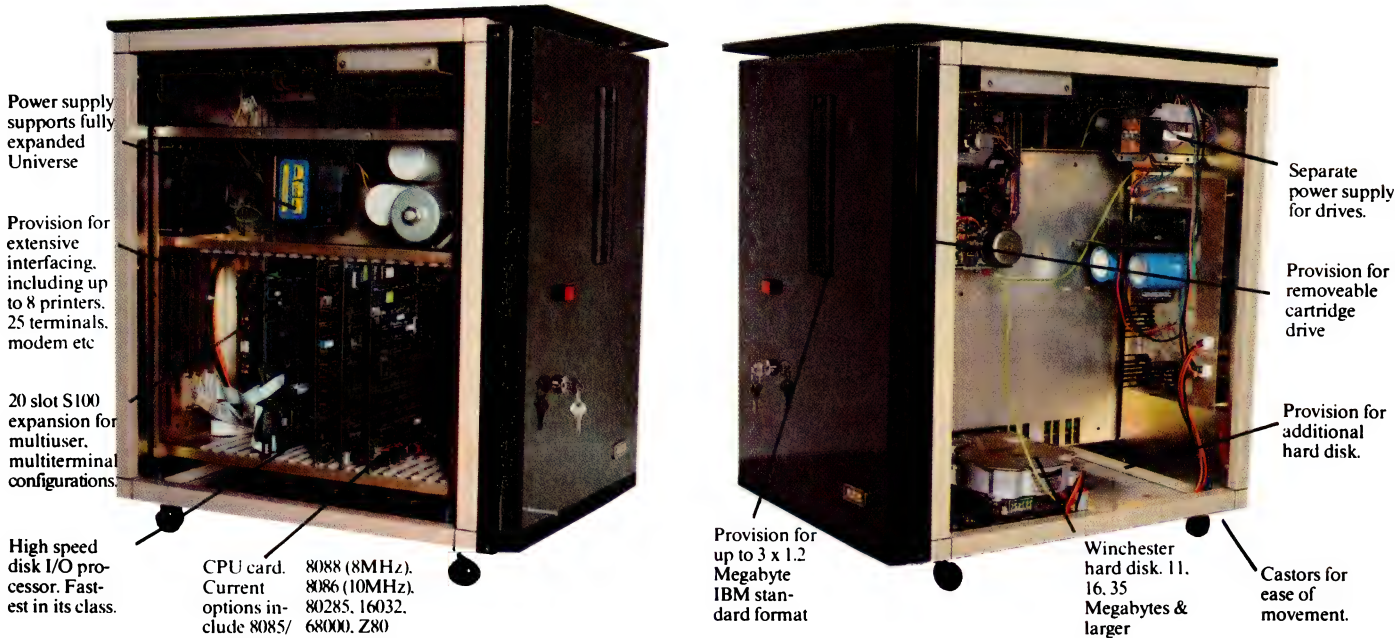

**Universe is the right computer for large and small businesses.** Totally modular design means it's right for your needs *this* year yet able to grow inexpensively *next* year.

Costing no more than some similarly optioned personal computers, Universe provides reliability, expansion potential and speed that these machines cannot offer:

Here are some of the reasons why you should consider Universe over other computers:

**1. You'll keep it longer!**

Universe can be upgraded - no need for expensive replacement of a machine that can't do the job. No need to pay for more machine

than you need right now. As new developments come along they are available *first* on Universe and they plug straight in.

**2. If there is a program dead right for your business there is more chance it runs on a Universe.** You have access to over 75% of available application software. Most PCs give you access to less than one third of this software.

**3. Universe can expand to help your whole business.** Adding extra workstations is fast and easy. A few PCs offer 'networking' where several small computers share the data storage. This arrangement is *unworkably slow* in the majority of business

applications. Universe provides the right solution. Our Multiuser system gives everybody fast access to information.

**4. Universe lets you do several things at once.** Other computers only let you do one thing at a time. Swapping between programs is slow. Using our unique MPS (Multiple program facility), Universe lets you move between any 10 programs almost instantly - an incredible time saver.

**5. Universe gets its work done faster.** On industry standard sorting tasks (which relate to many tasks you will probably use the computer for) Universe runs 3 times faster than an IBM PC and twice the speed of and NEC APC.

See us at

THE FOURTH AUSTRALIAN  
PERSONAL  
COMPUTER  
SHOW

CENTRE POINT

PC  
85

SYDNEY 13-16 MARCH 1985

# UNIVERSE SUPERCOMPUTER

NOW WITH  
80286 & Z80

# All the software you'll need:

Here's just a sample of the software running now on the Universe Supercomputer.

## LANGUAGES

Aztec-C86  
Aztec-C11  
CIS Cobol Level II  
BDS-C Compiler  
Pascal MT+  
Assembler  
C-Compiler  
C-Basic  
PL/I  
Basic Interpreter  
Cobol Compiler  
Access Manager  
Animator for Cobol  
Fortran 77  
C-Basic 86

## DATA MANAGEMENT

Friday  
Rescue  
FMS-80  
Data Minder  
Datastar  
Dbase II  
Dbase II (report writer)  
Quickcode  
Condor  
Knowledgeman  
Mdb3 III  
Infostar  
Dataflex  
Delta

## COMMUNICATIONS

BSTAM  
BSTMS  
Hite  
Term 2  
YAM  
XMODEM  
XYAM

## WORD PROCESSING

Wordstar  
Spellstar  
Mailmerge  
Star Index  
Spellguard  
Postmaster  
Typequick

## DEVELOPMENT

Wordmaster  
Macro-80  
Sid & Zsid  
Mac  
Aztec-C  
Distell & Disilog  
Rasm-86

## ACCOUNTING

Davidson  
I.A.L.  
Padmede  
I.M.S.  
A.M.S.

## INDUSTRY SPECIFIC

Manufacturing  
Medical  
Restaurant Accounting  
Video Library  
Sales Organisations  
Dental  
Pharmacy  
Dietician  
Legal Retrieval  
Management  
Real Estate

## OPERATING SYSTEMS

CP/M-80  
CP/M-86  
Concurrent CP/M-8/16  
Concurrent MP/M-8/16  
Concurrent MP/M-86

## FINANCIAL MODELLING & STATISTICAL ANALYSIS

SuperCalc-86  
Micromodeller  
Masterplanner  
T/Maker III  
CalcStar  
Abstat Statistics  
Scratchpad 2.0  
Statpak  
Milestone  
Planfin  
Profin  
Micronet  
Multiplan

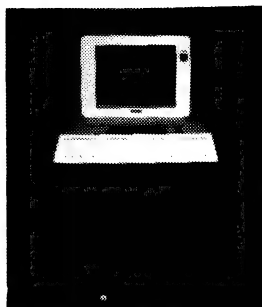

Please send me further information on the Universe Supercomputer.

**Note:** We have special arrangements for consultants and dealers. Please contact Wayne Wilson on (02) 636 7677.

Name \_\_\_\_\_

Address: \_\_\_\_\_

Phone: \_\_\_\_\_



**Sydney:** Unit 3, Prospect Industrial Centre, 2 Stoddart Road, Prospect (02) 636 7677

**Melbourne:** 53 Waverley Rd., East Malvern Vic (03) 211 5542

**Canberra:** 217 Northbourne Ave., Canberra ACT (062) 47 3403

**W.A.:** AED WA, Computer Services of WA (09) 450 5888



ONE OF THE great lessons a career as a specialist journalist has taught me is that you can't tell people what's good for them.

Well, you can *tell* them, but you can't expect them to behave as if they believe you. What usually happens is they nod their heads, agree with you, and then go away and do it differently anyway.

Look at the motor industry, for example (there is an extraordinary number of parallels between the car business and the computer business):

motoring writers spent years telling people there were better cars than Holdens; the people bought Holdens. Then they told them how bad the (early) Japanese cars were; the people bought Japanese cars. More recently they have been telling people Holdens are good; the people have stopped buying Holdens.

That's a generalisation (no motoring puns here), but it's a fair illustration of the point – what the people want isn't always what's best for them if you judge it purely on performance,

# NORT NEW

quality or value. There are usually other reasons – ones that are unimportant to the 'expert', but meaningful to the user – which make up their minds for them.

So now I tell people they *should* buy an IBM when they ask me. Why waste my breath telling them how much better a Morrow MD11 (or any one of a dozen other machines, depending on the application they are asking me about) would be when they are going to buy the IBM anyway?

## Make Way for the Clone

The real problem is when they ask me to choose between an IBM PC and a lookalike. It really hurts me when I have to be vocal in my support for the IBM ...

As far as I'm concerned, if you want IBM compatibility then you buy IBM. Anything else is, like the 'CP/M compatible' operating systems we have criticised before, compatible only on the day of its release. You will always have to live with the possibility that the next great software release/hardware add-on won't work on your particular machine.

Of course, there are many cases where that won't matter (more likely is the fact you will tell yourself it won't matter), but I still feel you need to find compelling reasons – like a huge cost advantage, or extra features you just can't get on the IBM – to stray into the compatible camp. (Having said that, let me add I can already see good reason to buy

*Matt Whelan says he likes IBM clones even less than he likes IBMs, yet he found NorthStar's Dimension – a multi-user IBM PC workalike – offers enough 'extras' to be a worthwhile alternative.*

# HSTAR's DIMENSION

one or two of the compatibles; I just don't know if I would risk living with them.)

A new machine from NorthStar, one of the 'oldies' in the micro business, is one of the rare recent additions to my list of acceptable IBM alternatives. It makes it onto the list because it is a multi-user machine which offers a real price/performance advantage.

I first saw the Dimension at Comdex/Fall in Las Vegas a year ago, and while I thought it was an interesting exercise I never imagined it could be turned into a real 'compatible'. There are just too many extra problems involved in running multi-user, especially when you have to stick with an operating system which makes no allowances for multi-user operation.

NorthStar came up with a two-stage solution to the problem. First it worked on compatibility: the machine, as released in May 1984, would run most PC programs including the test 'standards', Lotus 1-2-3 and Microsoft's Flight Simulator.

However, it was more a 'box full of individual IBM PCs' than a true multi-user machine. Apart from a shared main drive for programs (this drive could only be written to by the system manager) the users were given their own hard disk partitions and could not share data between them or even see each other's files.

Even in this form the Dimension was a useful device. After all, it did provide shared peripheral resources

(printers, hard disks and so on) and shared program access, the important points in making it a cost-effective multi-PC solution.

## **Real Multi-User**

Stage two was a revised operating system, shipped to customers in October, which turned the Dimension into a 'box full of networked IBM PCs'.

The new operating system (revision 1.1.0) incorporates 3COM Ethernet semaphores, allowing multi-user programs designed for network operation to operate in true multi-user mode with file and record-locking. Ethershare packages supported at release time included Cyma accounting software, dBase II, DataFlex, Informa, Datastore:lan, Open Systems A/R and Inventory, and Probase.

The new operating system also allows shared disk partitions, removing one of the major limitations on the Dimension – before, even if you fully understood the dangers of having more than one person sharing data files, you had no choice; you simply couldn't do it.

## **Three-Dimension Designs**

There are really three separate components in the Dimension design: the central unit, the workstation electronics and the workstations themselves.

The central unit houses the shared storage and back-up facilities – a 360K IBM-format floppy, one or two hard disks with capacities of 15M to

120M (the 120M model is scheduled for local release in February, and will be followed later in the year by a 240M option) and an optional 45M tape unit – as well as the 'server' processor and 256K of cache memory (upgradeable to 512).

The processor is a 6 MHz Intel 80186 (the new, high-speed upgrade of the 8086) whose sole task is to handle the shared facilities – each workstation has its own processor and memory.

Also included in the central unit are ports for three shared printers (two serial, one parallel), a battery-backed clock, and an IBM-compatible bus of 13 slots. One of the serial ports is programmable for multiple protocols, and can be used for communications links including asynchronous, bisynchronous, SDLC and others.

The 13-slot bus is the second component of the design. It will accept processor/memory cards for each workstation added, and can also take IBM peripheral cards (the cards can be shared by each workstation).

The Dimension can handle up to 12 users (the basic configuration includes two); you wouldn't want to buy too many peripheral cards if you were planning to expand it fully.

Each workstation board includes its own 7 MHz Intel 8088 processor (compared to the IBM's 4.77 MHz unit) and 128K of memory (expandable with 128K and 384K piggy-back add-ons).

The cable from central unit to workstation terminates in a small box

# NORTHSTAR'S DIMENSION

which includes a plug for the separate IBM-style keyboard (which has the keys labelled properly, and provides caps lock and num lock lights), outlet for the monitor, and an individual serial port usable for a local printer, communications, or an optional mouse.

The monitor is a high-quality 30 cm green screen, with 25 lines of 80 characters and 640 by 200 and 640 by 400 resolution graphics modes.

The standard cable provided is around eight metres long, but extensions of 30 metres are available. Bulk cable can be spliced into a standard cable to provide a connection up to 300 metres long – although at \$7.25 a metre it's an expensive proposition to sit too far from the computer.

The central unit is housed in a box 500 mm by 300 mm by 600 mm, and can be either laid flat or stood on end. Self-adhesive rubber feet are provided for the user to fit once he/she has decided which way the unit will be mounted. Vertical positioning seems to be the preferred method, and as the non-rotatable NorthStar badge suits this orientation I assume that's how the company intended it.

Set up this way it fits neatly beside

a desk, with the floppy drive within easy reach at the top of the unit.

The unit weighs 27 kg and, when packaged in its giant foam-padded cardboard box, is an unmanageable lump for one person.

The front panel is finished in black with a slotted design hiding two air-circulation cutouts under the floppy drive. Two fans cool the internals. A key-operated switch turns the unit on and off.

## The Operating System

The Dimension operating system is a modified version of MS-DOS 2.0, with enhancements to suit the multi-user environment. It includes the following 'extra' commands:

**DISKBOOT** – allows booting the workstation off the floppy diskette rather than running under DOS, for those auto-boot protected programs.

**DISKLOCK** – moves the hard disk heads to a safe spot when you want to move the central unit.

**LOCAL** – sets the printer, communications or mouse port assignment to the workstation's own serial port.

**MAIL** – provides electronic mail between users on the system.

**MAINT** – Used by the system manager to set up shared printers, create disk partitions, add and change users, and set up user/disk profiles.

**MANAGER** – toggles manager mode on and off. Only the system manager can modify the shared system drive (C:) to update or add new applications software. Manager mode can only be entered when no other users are on the system.

**PRINTER** – allows the user to select which printer will receive his documents at any time.

**PRINT** – manages the shared printers with an intelligent spooling system.

**PROFILES** – shows the currently assigned user profiles with their disk partition details and so on.

**REQUEST/RELEASE** – used to allow private access to the floppy disk drive.

**RESTART** – restarts a hung workstation. Also required to reboot a console after completing a DISKBOOTed application.

**SETDATE/SETTIME** – alters the on-board clock.

**SIGNOFF** – takes the user off the system and leaves the console in the name/password log-in mode.

**STATS** – provides statistics on the use of space on a fixed disk and lists the partitions.

**USERS** – shows a list of consoles and, if in use, the user logged in.

## What Software Will Run?

One of the major problems with software packaged for the IBM is that it is pre-installed for the IBM. Anything a little different, like the NorthStar is in some areas, sometimes requires special attention.

Fortunately NorthStar recognises this, and has put a lot of effort into producing installation guidelines for a many packages as possible.

The installation notes are detailed and clear, like the NorthStar manual. However, they are not provided direct to users, so purchasers will have to rely on their dealers for this critical support for difficult software. Thankful the installation process is simple for most packages ...

The current set of notes covers around 60 programs, including: BPI Accounting, Crosstalk, DataFlex, dBase II, Easywriter II, Home Accountant Plus, WordStar, InfoStar,

## SPECIFICATIONS AND REPORT CARD

Unit:	Dimension			
Made by:	NorthStar Computers, San Leandro, California.			
Processor:	Intel 80186 and 8088s			
Clock speed:	6 MHz and 7 MHz			
RAM:	256K central unit, 128K workstation			
ROM:	Bootstrap			
I/O:	Two RS232, one parallel, one RS232 each workstation			
Languages:	BASIC provided, many available			
Keyboard:	IBM PC layout (yecch!)			
Display:	80 by 25 green screen			
Expansion:	Winchesters, tape drives, up to 12 workstations			
Best points:	Multi-user, IBM compatibility			
Worst points:	IBM compatibility			
<b>Ratings:</b>	<b>Excellent</b>	<b>Very Good</b>	<b>Good</b>	<b>Poor</b>
Documentation:	●			
Ease of use:		●		
Functionality:		●		
Support:		●		
Value for money:		●		
Options available:	IBM add-on cards, extra memory, colour monitors, extra disk capacity, tape drive.			
Extras included:	Comes with two workstations			
Price:	From \$12,200			
Review unit from:	New Dimension Computers, 15 May Court, Dandenong 3175. (03) 792-4152.			

The inner workings of the Northstar – with room for further expansion to provide for 12 users. ▶

Informa, KnowledgeMan, Lattice C, Lotus 1-2-3, Symphony, Flight Simulator, Microsoft Word, Multimate, Multiplan, the pfs: series, R:base, Sidekick, Spellbinder, SuperCalc, SuperWriter, VersaForm, VisiCalc and WordPerfect.

There are a few problems owners will just have to live with – for example, you can't use WordStar's concurrent editing and printing feature without the risk of hanging the workstation.

### What Won't Run?

The only real problems we experienced in trying IBM software on the Dimension was with Prolok-protected disks.

Under version 1.0.2 of the operating system, a Prolok'd dBase III hung the workstation immediately. Under the latest version it got as far as trying to read the Prolok 'signature' on the floppy and then hung.

NorthStar is working on the Prolok problem, although Ashton-Tate at least has abandoned the Prolok system. Hopefully its new copy-protection system won't cause similar problems.

We were able to run non-Prolok versions of dBase III and Framework quite happily, so the 'real' software works just fine.

### The Good Books

The Dimension is supplied with two manuals, a system manual describing the machine and detailing installation procedures, and a DOS manual – effectively a Microsoft MS-DOS manual rewritten by NorthStar to cover the changes in the operating system.

The DOS manual seemed to be a distinct improvement over other versions I've seen. Without sitting down and comparing it directly with the IBM DOS manual, I can't say why it is different, yet I certainly felt it was more informative. Naturally, the information in it isn't a lot different – perhaps it is simply better laid out.

The system manual is excellent, taking the user through step-by-step instructions on setting the machine up, installing software and peripherals, and managing the system. It has good descriptions of the role of the system manager, and various charts and so on to help make the job easier. It even tells how long each

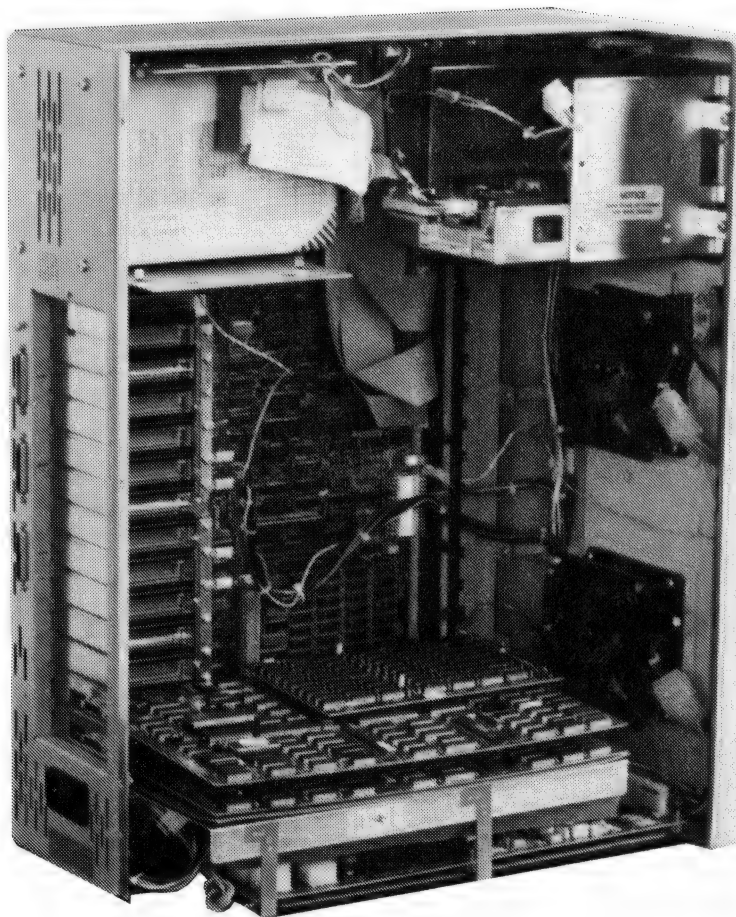

task should take, and suggests sensible break points if you don't want to work through the whole job at one sitting.

Another thoughtful touch is the provision of shorter 'User's Guides' with each workstation, detailing only the day-to-day information required to use the system. The lack of such guides is a major problem with many multi-user systems, where the system manager either has to prepare limited documentation or give the user the full system documentation – usually a problem both for the user (it's heavy stuff to wade through) and the system manager (too much knowledge can be dangerous...).

### The Final Dimension

I had grave doubts about the Dimension when I first saw it on the NorthStar stand at Comdex in 1983, and I must admit to still being sceptical when Australian agent New Dimension Computers offered us one for test.

But after using it on and off for two months, I've changed my mind. Apart from its objection to Prolok disks, it ran everything I tried. It never gave me a problem, even with communications – generally one of

the trickiest things to implement on a non-standard machine, and often impossible on multi-user computers.

In single-user mode it is extremely fast, while even with two users operating performance doesn't seem to deteriorate noticeably (however, two was the biggest load we were able to subject it to during our evaluation, and increasing the number of users would obviously take its toll).

Pricing is more than competitive with multiple stand-alone PCs, and if you compare the Dimension with a comparatively configured PC network it comes up at almost half the cost.

For example, a basic two-user 15 megabyte system sells for \$12,202; a four-user, 30 megabyte version would cost just over \$19,000. Adding a workstation costs \$2700, including green-screen monitor (colour versions have just been announced), keyboard, cable and 128K processor board. Memory expansion is \$813 for 128K, and \$1832 for 384K.

If you need more than one machine, want to share resources and information, and don't want to pay too high a price for it, the Dimension may be your solution. □

# More bytes

First shipment sold out in days . . .  
So popular we've had to air-  
freight new stocks in . . .  
The greatest value you'll ever  
see . . .

## That's the new Bondwell 14 Portable computer: EXCLUSIVE to Dick Smith Electronics

Simply brilliant! That's the all-new Bondwell 14 portable personal computer. Small wonder it has become one of America's top-selling computers in just a few short months - and now the same thing is happening here in Australia.

It's everything you've ever wanted in a computer and much, much more besides: small enough to go anywhere with you, yet large enough to do virtually any computing job.

This incredibly powerful personal portable operates from the world-standard CP/M system: which means there will always be an incredibly large range of software available for it. For virtually any purpose.

That's if you ever ever need any other software: the Bondwell 14 comes with over \$1200 worth of top quality business software (including Wordstar word processing!).

## Look at what else you get:

- Twin double density, double sided disk drives inbuilt (360K capacity each)
- 9in amber screen inbuilt - for minimum glare and fatigue
- Standard parallel and twin RS-232C interfaces inbuilt
- 16 user definable keys for incredibly easy use
- CP/M version 3.0 including a host of utility software - even a SPEECH synthesiser (it can read to you in English!)
- Ergonomically designed keyboard & durable cabinet for complete portability
- PLUS over all this famous Micropro bundled software: Wordstar, Calcstar, Mailmerge, Datastar, Reportstar - worth over \$1200.00! Cat X-9000

**OVER \$1200 WORTH OF  
SOFTWARE FREE!**

All this  
for **\$2295**  
only

\*Or from \$233 deposit and \$18.23 per week over 48 months to approved applicants. Commercial Leasing also available!

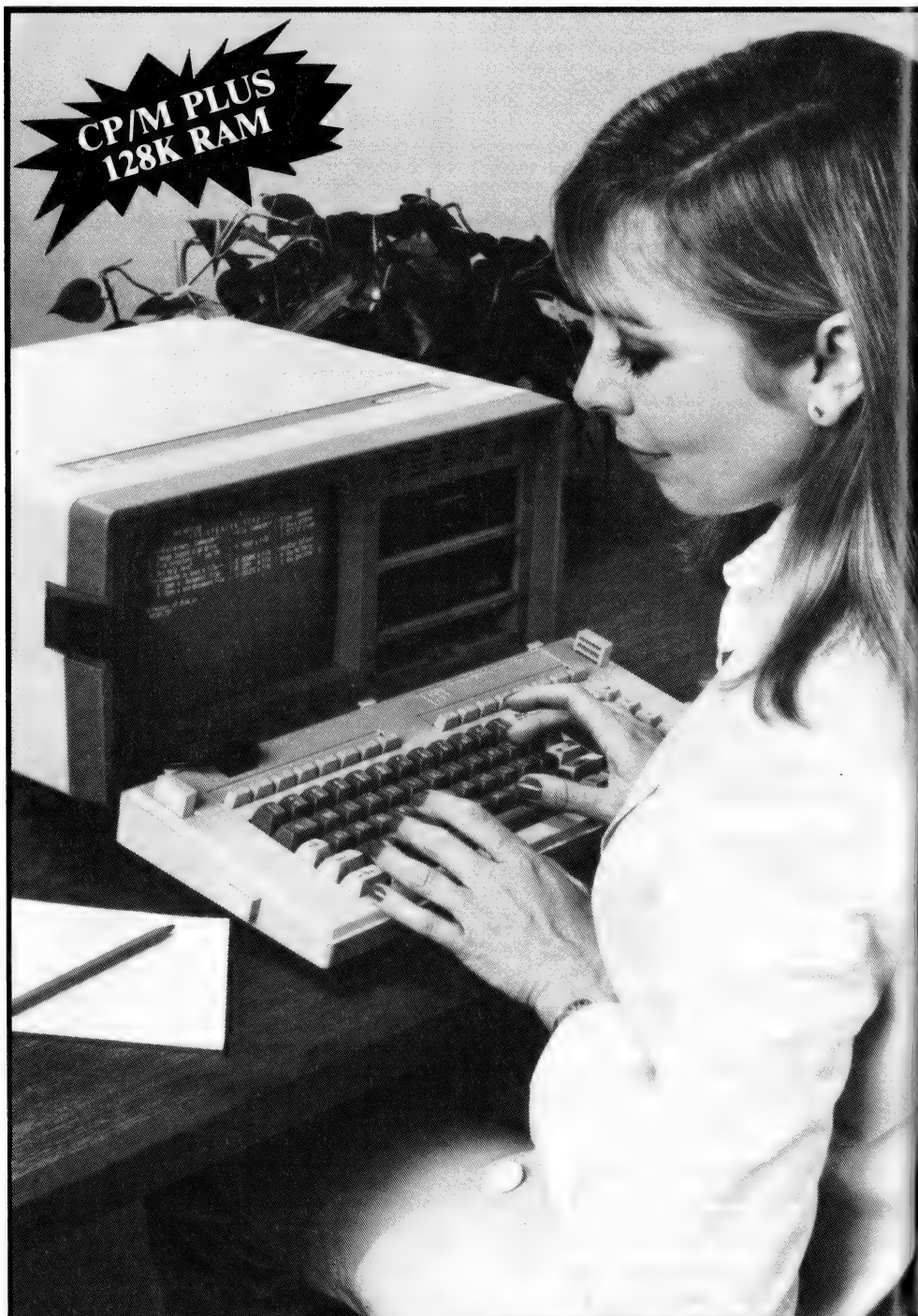

Dick Smith Electronics Pty Ltd

**COMPUTERSTOP**



# for your bucks!

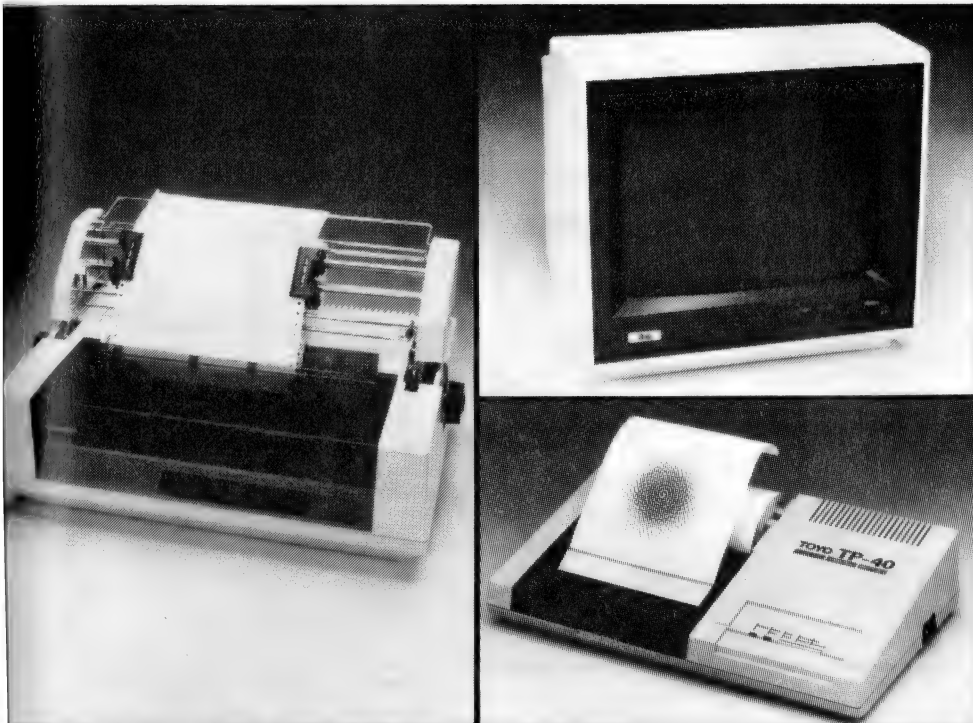

## Uchida Daisywheel Printer

Top quality printing at a budget price. Prints at 18 cps and offers a choice of 3 pitches plus proportional. Standard Centronics type interface. Cat X-3270

Save \$120  
Now only **\$575**

Tractor feed shown is optional (Cat-3273 @ \$99.50).

## Quality Japanese Hi-Res Monitors

Green: X-1222  
Amber: X-1227 **\$249** each

## TP-40 Four Colour Printer Plotter

Incredible performance at a bargain price. Centronics type interface. Cat X-3245

LAST YEARS PRICE \$229  
Now only **\$99**

## Apple II software compatible CAT!

Australia's best value 64K Computer. That's the CAT. It's the best of both worlds: the very latest and most powerful hardware, plus the ability to run a very broad range of tried-and-proven software. If you want a machine which is software compatible with thousands of popular programs and which is supported by a reputable dealer, our CAT with emulator is good value. Check the CAT out at your nearest Dick Smith Electronics Computerstop. It purrs.

### Save \$232 on CAT system!

	Cat. No.	Normally
Basic CAT Computer	X-7500	\$ 699.00
Disk Drive	X-7505/6	\$ 349.00
Disk Controller	X-7510	\$ 149.00
RF Modulator	X-7550	\$ 34.90
		<b>\$1231.90</b>

SPECIAL OFFER!  
VALUE AT ONLY **\$999**

\*Or \$81 deposit and \$8.31 per week over 48 months to approved applicants.



Dick Smith Electronics Pty Ltd

# COMPUTERSTOP



nearest Dick Smith Electronics Centre.

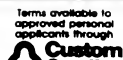

# CAN YOU AFFORD TO BE WITHOUT A **MINDER**

The most complete and affordable system includes:

**\$3600**  
inc. tax

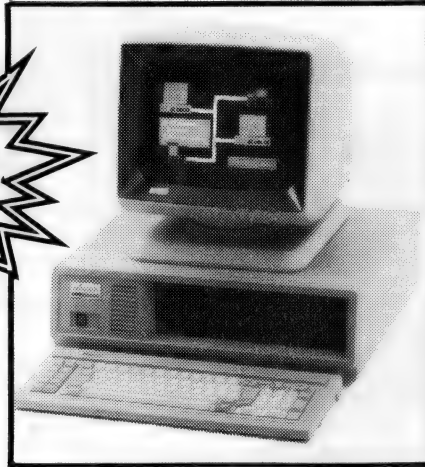

**Dealer enquiries welcome**

For further information contact:

**CONSULTECH AUSTRALIA PTY. LTD.**  
271 Blackburn Road, Mount Waverley, Victoria 3149  
Telephones: National (03) 233 8999, 233 8273

**OPTIONAL ACCESSORIES**  
10M byte Hard Disk Drive  
Local Network System  
Colour Monitor  
Intelligent Modem

#### MAIN BOARD

- 16 Bit intel 8088 4.77 MHz processor
- 256K RAM standard (expandable to 704K RAM)

#### DISK CONTROLLER AND I/O BOARD

- Controls two floppy disk drives
- Serial RS 232 port
- Parallel centronics port
- Games port
- Clock and calendar (battery backed)

#### MAGIC DISPLAY CARD

- Monochrome display mode
- Colour graphics display mode
- Suits most types of monitors

#### FLOPPY DISK DRIVES

- Two doublesided, doubledensity 5 1/4 inch floppy
- Formatted capacity 360K bytes (9 sectors)

#### KEYBOARD

- Ergonomic design sculptured keys, low profile
- 83 keys, 10 function keys, LED caps-lock and num-lock keys
- Functionally IBM-PC compatible

#### MAGIC VIDEO MONITOR

- Green or amber
- Tilt and swivel
- Totally compatible with magic display card

#### OPERATING SYSTEM

- MS-DOS 2.11 licensed by Microsoft

#### OPEN ACCESS SOFTWARE

- Electronic spreadsheet
- 3-D graphics
- Word processor
- Appointment scheduler
- Telecommunications module
- Revolves around powerful information manager

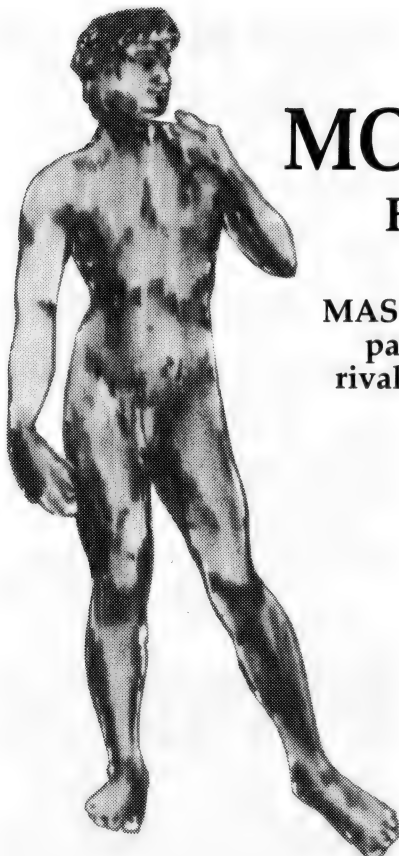

## From one **MASTER MODELLER** to another . . .

For those who do present day modelling at the keyboard

**MASTERMODELLER** is a new financial planning and reporting package, designed to complement today's powerful micros rivalling the best mainframe systems and surpassing all other micromodelling and reporting packages.

- reports produced via screen generator
- NPV, IRR and conditional logic functions
- can create menus and automated run files
- extensive conversion aids supplied
- consolidations specified graphically, then automatically encoded
- backward iteration or goal seeking
- case studies supplied



Available from **Intelligence (AUST) Pty Ltd**  
SYDNEY: 62-64 Shepherd Street, Chippendale, 2008 (02) 699-3877  
MELBOURNE: 123 Moray St., South Melbourne, 3205 (03) 690-6600

*Practically everyone knows that one of the cheapest direct-connect modems around is Applied Technology's BeeModem, priced at a tantalisingly low \$149.50. But it's only designed to work with the Microbee – right? It ain't necessarily so. In fact Jim Rowe has worked out a simple way of using it with other computers. He's been trying it out with an IBM PC...*

# BEE MODEM GETS A PC OF THE ACTION

IT'S VERY pleasant coming back into the magazine business after a break, I'm discovering. I'm not only renewing a lot of old friendships, but also getting to know a lot of the new products that have appeared in the last four years. It feels a bit like Rip Van Winkle waking up!

One of the very enjoyable things I was able to do, a few weeks ago, was pop up and visit Owen Hill at his thriving factory in West Gosford. It was great to see Owen again, and a real eye-opener to see all the Microbee computers and the various add-ons rolling off the Applied Tech lines. Who says initiative is dead in Australia?

Anyway (and I am getting to the point, don't despair), one of the Microbee add-ons I saw coming off the lines was the BeeModem. This attracted my attention immediately, because during my sojourn away from magazines I actually had to design a broadly similar product.

From even that fleeting glimpse, the BeeModem looked to me a very interesting little beast – particularly when I discovered its retail price. So when I was leaving at the end of the visit, I asked Owen if this magazine had reviewed it yet. Surprisingly, the answer was no – so I immediately arranged to remedy that shortcoming.

## Trying It Out

When a sample BeeModem duly



arrived, I was impatient to try it out with my recently acquired IBM PC (or even my old System-80!). It was that night (shock horror) that I discovered the awful truth: the BeeModem was designed specifically as an add-on for the Microbee! It had no power supply, for example, being arranged to get its power from the Bee itself. Why hadn't anyone told me?

It set me back for a few minutes. Then I started thinking. The modem plugs into the Bee's serial port, which is supposed to be a pretty standard RS232C set-up. So the modem should have pretty standard interfacing,

apart from the fact that it is obviously designed to get its power from the Bee. Perhaps with a bit of ingenuity it would be possible to get it going with the PC and/or System 80 after all.

The easy way would have been to borrow a Bee, I suppose, and review the modem with its 'intended'. But anyone could do that, and besides, I wanted to see how the BeeModem would go with other computers – particularly mine! Who knows, there are probably a lot of YC readers out there who may have looked longingly at the BeeModem and wondered if it

# BEE MODEM

Adapter to use BeeModem with the IBM PC and other computers.

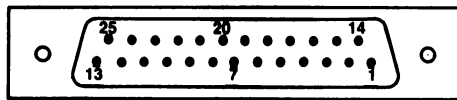
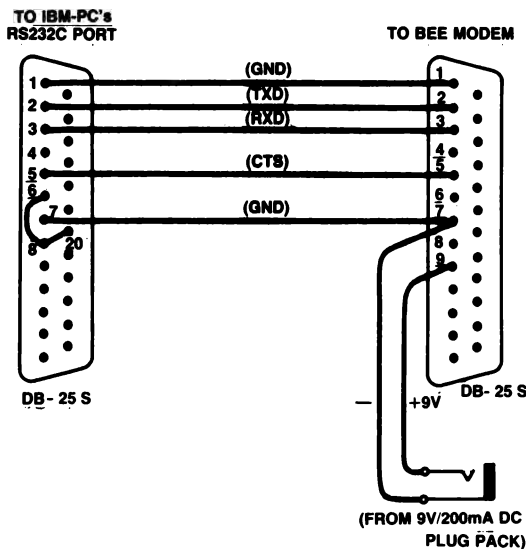

DB-25 SOCKET VIEWED FROM SOLDER LUGS SIDE

would be capable of working with their system.

Next morning I rang Owen, who confirmed that the modem's basic interface was indeed pretty standard RS232C. And yes, it should be capable of being hooked up to other computers without much hassle. In fact, he'd send me the technical info to make it easier. What more could I ask?

## Not Too Hard

In a day or two the promised info duly arrived, and a quick inspection showed that adapting the BeeModem to other computers shouldn't be much of a problem. Its data interface is fairly basic, but does conform to the RS232C standard in most respects – certainly enough to satisfy the serial ports of most small computers. This includes the use of a DB-25 connector.

Transmit Data input (TXD) and Receive Data output (RXD) use fairly standard logic levels and connect to the standard pins 2 and 3 respectively. Signal ground is also standard, on pin 7.

There is no provision for handshaking on the BeeModem at present (more about this a little later), but some of the usual handshaking outputs from a modem are tied to logic 'high' level to help prevent software hang-ups. The pins concerned are Clear To Send (CTS), Data Set Ready (DSR) and Carrier Detect (CD), on pins 5, 6 and 8 respectively.

When the BeeModem connects to the Bee it gets a supply of +9 volt DC power via pin 9 of the DB-25 connector. The negative power connection is made via pin 7, the normal signal ground pin. However, the modem will run on almost any source of low voltage DC between 8 and 12 volts, drawing somewhere between 80 and 200 milliamps depending on the voltage supplied. So to use it with a different kind of computer, the main thing you need is a small DC power supply delivering around 9-12 volts and capable of supplying up to 200 mA.

One of the small 'plug-pack' supplies turns out to be just what the doctor ordered. I used a type M-9514 from Dick Smith Electronics, which

cost only \$6.95 and worked just fine.

To check out the basic idea of the using the BeeModem with the PC without making any mods to either, I decided to make up a small cable adapter. The connections are shown in the diagram, and as you can see it simply connects a couple of DB-25 sockets together with a 3.5 mm jack socket to take the 9V DC from the plug pack. This connects to pins 9 and 7 of the modem socket.

Because the BeeModem doesn't provide any real 'handshaking' signals, I wired pins 20 (DTR), 8 (CD) and 6 (DSR) together on the socket connecting to the IBM PC's serial port. This is basically a 'null modem' arrangement, so that when the IBM sends out its 'Data Terminal Ready?' signal on pin 20, this will automatically generate the CD and DSR signals it would normally look for from the modem.

The link between pins 5 of the two sockets is to ensure that if the IBM looks for a Clear To Send signal at pin 5, this will be provided by the BeeModem's pull-up resistor on this pin. So the basic idea of these connections to pins 5, 6, 8 and 20 is to fool the IBM into thinking that the BeeModem not only has proper handshaking, but that it is also 'ready to go' whenever the IBM wants to send or receive.

By the way, it might be possible to achieve the same result simply by joining pins 6 and 8 of the IBM socket to the same pins on the modem socket, ignoring pin 20. This is because pins 5, 6 and 8 are all tied high in the modem. However, I didn't try this, because I noticed that all three pins actually use the same pull-up resistor – so they're connected together. I suspect this could cause complications with some computers, so I decided to use the connections shown.

Of course RS232C connections like this can look great on paper, only to sit there and sullenly refuse to communicate when you try them out. So how did it perform in practice?

## It Worked!

Great sighs of relief – when I tried out, using a suitable terminal program for the IBM (kindly provided by the ever-helpful Matt Whelan), it worked like a charm. I've called up quite a

few bulletin boards over the last couple of weeks, and the little BeeModem hasn't corrupted a character. I'm sure the PC hasn't twigged yet that it's working with such an el-cheapo modem!

Altogether I'm very impressed with the BeeModem. Considering its very low price, it really provides just about everything most people are likely to want in a modem - at least for quite a while: Originate/Answer switching, simple Phone/Modem switching, plus a pushbutton phone with memory redial. Nothing very fancy, but a practical Volksmodem at a very attractive price. And it works well - even with an IBM PC.

Mind you, I did find a couple of little things about it I thought could be improved. One was the rather ugly little bracket (cradle?) attached to the top of the box, and obviously intended to take the pushbutton phone when you're not using it. Frankly, this thing not only spoils the look of the modem, but it's also a damn nuisance - it makes it very awkward to get the phone into the bracket, being fairly obviously designed not for horizontal use, but for vertical mounting on a wall. And even if you manage to get the phone into it, there's a further problem: the shape of the bracket seems to prevent the phone's switch-hook button from working reliably. So half the time the phone stays on line when you think you've hung up.

Luckily the answer to this is very simple and easy - you simply ignore the bracket altogether, and hang up the phone by plonking it flat down on the desk.

The other thing I found disappointing about the BeeModem was its lack of any kind of handshaking, or even a 'Carrier Present' indicator. Something along these lines would make it quite a bit more convenient to use, because then either you or the software would be able to at least check for a carrier if things should suddenly grind to a halt.

I believe the BeeModem is based on the fancy AMD 7910 'modem in a chip' IC, which does provide a Carrier Detect output for this kind of use. If this is the case, I think a CD indicator LED and even a CD logic output could be added to the modem with very little increase in cost.

I haven't actually tried it with the old System 80 yet, but I'll be very surprised if it doesn't work first pop. And I think you'll find that the simple adaptor shown in the diagram should get the BeeModem working with most common computers, provided they have a fairly standard RS232C serial port.

The secret's out then: the BeeModem is really quite compatible with lots of other computers, not just the Microbee. Once the news gets around, I have a feeling the folks at Applied Technology are going to be working pretty long hours to keep up with the demand.

### Stop Press!

I rang up Owen Hill of Applied Technology just before sitting down to write this article. Along with the 'good news' about how well it had performed with the PC, I couldn't resist having a little dig about its few shortcomings.

You have to hand it to him. He immediately undertook to look into both the idea of removing the phone bracket from the top of the modem box, and the feasibility of adding a Carrier Detect indicator LED. Not only that, but a few days later he called in and plunked a sample 'Mark 2' BeeModem on my desk - sans attached bracket and avec a CD LED. How's that for a positive and speedy response?

I've tried out the new model, and it's fine. Owen tells me production models will be changed over as soon as possible, with no increase in cost. So very shortly there'll be the new Mark 2 BeeModem, which is even better value for money than the first. For a no-frills Volksmodem, I believe it'll be hard to beat.

Now I've found out how easy it is to use it with the PC, I've even taken the plunge and ordered one myself!

*Jim Rowe was editor of Electronics Australia for many years, before leaving the publishing industry to become Technical Manager and Marketing Manager for Dick Smith Electronics. In mid-1984 he came back to publishing when he became Managing Editor of the Electronics Group of Federal Publishing Company, the publisher of Your Computer.*

# LOOK!

TOP 10 II+/e/c



1 ● **Flight Simulator II** - Put yourself in the seat of a Piper 181 Cherokee and reach for the sky. High-speed colour 3-D graphics give a great view as you practice takeoffs, landings and aerobatics over New York. Then try the aerial battle game. A-1 documentation.

	RETAIL	YOU PAY
1 ● Flight Simulator II	\$79.95	\$72
2 ● Bank St Writer	\$99.95	\$83
3 ● Wizardry	\$79.95	\$68
4 ● Lode Runner	\$49.95	\$42
5 ● Championship Lode R	\$49.95	\$42
6 ● Crossword Magic	\$84.95	\$71
7 ● Mastertype	\$59.95	\$49
8 ● Suspended	\$74.95	\$62
9 ● Printshop	\$69.95	\$58
10 ● Zaxxon	\$59.95	\$49

### MAC TOP 10

1 ● Filevision	\$275	\$231
2 ● Transylvania	\$69.95	\$58
3 ● Main St Filer	\$299	\$248
4 ● PFS File	\$205	\$168
5 ● Mac Coach	\$205	\$168
6 ● PFS Report	\$205	\$168
7 ● Megamerge	\$210	\$175
8 ● Think Tank	\$210	\$175
9 ● PFS Bundle	\$320	\$268
10 ● Mac the Knife	\$64.95	\$54

3.5" microfloppies \$8 ea \$69 ten

### BUY AUSTRALIAN MADE

AND KEEP YOUR JOB!

Zardax II+/e/c	\$220	\$169
SWS-1 Storage Box holds sixty 5" hinged perspex top, dividers	\$29	\$21
Control Data 5" SSD	\$33.95	\$25 ten
Xidex bulk: plain label no box -		
5" SSD 5014	\$43.50	\$29
5" DSD 5024	\$51.50	\$38
Xidex standard 5012		
5" SSD	\$54.50	\$36
Xidex standard 5022		
5" DSD	\$59.60	\$45
Xidex standard 5" DSD		
96Tk	\$71.20	\$58
Xidex standard 8012		
8" SSD	\$61.40	\$49

### GREAT IDEAS DEPARTMENT

COLOURED RIBBONS - Red, green, blue suit Epson, Star, Oki, Apple, C-Itch, \$ CALL 008

### FAVOURITES DEPARTMENT

SPITFIRE SIMULATOR - II+/e/c \$51

Fly a 360mph WWII Spitfire.

● Take off & land on home scenery ● loops, rolls & stalls ● pursue & attack 8 moving 3-D aircraft (including Me109, Stuka, blimp)

C64 ATARI IBM CP/M OWNERS - call for

your top 10 lists

NATIONAL ORDER DESK 7D/8AM-8PM

STD FREE

# 008-025-241

LOCALS (049) 497-546

# immedia

WRITE: FREEPOST 3P IMMEDIA SOFT  
8 LYNDRHURST ST, DUDLEY 2290

AUSWIDE FREIGHT: Software or 10 disks  
\$2 Post BULK: Post \$5 Courier \$10  
CHEQUES, MONEY ORDERS TO 'IMMEDIA'  
LOCALS PHONE (049) 497-546  
● BANK ● VISA ● MASTER

# THE TYRANNY OF STANDARDS

By Evan McHugh

***The RS-232 Solution, by Joe Campbell, Sybex Computer Books, Berkeley, 199 pages.***

Among the major hardware bugbears in computing is the problem of interfacing. In particular, two RS232-compatible devices will often stoically refuse to talk to one another, leaving the computer owner in a blind rage of fury as hundreds of dollars of hi-tech equipment sits in contemptuous judgment on the feeble efforts to make the devices co-operate.

How many people must have thought that because two devices were 'RS232 compatible' it would simply be a matter of plugging them together and proceeding to use them? How often has this been shown to be further from the truth?

The main source of the problem, according to Joe Campbell in his book *The RS232 Solution*, is that the Recommended Standard Number 232, Version C, was set up with a specific purpose, and only that specific purpose, in mind. It was designed for connecting modems and computers – nothing else – in such a way that all the communications manufacturers could interchange their equipment and not have total confusion reign in their industry.

Since then, however, many other manufacturers of computer peripherals have seen the RS232 'standard' as a pretty good means of connecting computers and their particular product. The standard was never designed or revised to cover the numerous exotic devices that started getting plugged in through RS232 ports, so, when they weren't sure how to apply the standard to a terminal, printer or washing machine, they went for pot luck. They made guesses and compromises which have since become major causes of confusion when interfacing devices.

Campbell is a well-qualified electronics expert who has set out to detail the workings of RS232 interface for novices and to show them how to solve problems that a lot of retail stores lack the technical expertise to solve for their customers. His style is very good for technical writing at this level. He starts out giving a lot of background in a clear and easily understandable style, then introduces concepts and jargon gradually, so that by the time it is used constantly it is accepted and understood.

He considers some of the key

components involved in input and output and their various roles. There is, for example, a whole chapter on modems, and another on UARTs (entitled 'Elves in the Basement'), a UART being a Universal Asynchronous Receiver Transmitter. The book claims you won't need to use soldering irons and have great skill in electronics, but it is advisable to try and learn how to use a soldering iron so you can make up a proper cable to do your interfacing.

## The Key

The key to Campbell's book is, of course, a standard approach to determining the connection required between two devices. His methodology is a series of steps that are fully explained and well supported by the major part of the book, which is devoted to case studies of simple and complex interfaces the author has encountered that give a lot of clues on how to solve some of the curly problems presented by some equipment.

The steps Campbell takes the reader through are: set baud rate, ascertain the 'sex' of the equipment (plugs come in 'male' or 'female' configurations), satisfy device control logic, locate the handshaking, specify the cable. Hopefully, by page 90 of the book you will have understood enough about the subject to be able to approach an interfacing problem with a much calmer frame of mind and a better chance of success.

This is not the sort of book to approach as light reading. You can't whip through it in a matter of minute and expect to be able to get on with an interface. At least the first 100 pages need to be read and fully understood to have any real hope of success.

If you're wondering whether the book is worth buying you must decide how often you're likely to need to interface two devices yourself. How much is a custom-made cable likely to cost you if the supplied cable doesn't work? Is there anyone around you can get to make the cable up for you in the first place? Would you not be a little better off not having to rely on someone else; would it give you a little peace of mind or satisfaction to be able to do it yourself?

# Twelve awkward questions that will tell you if a PC is productive.

**1.** Is it a 16-bit model like the AWA Corona - powerful enough to cope with all your business requirements?

**2.** Is it fully compatible with readily available IBM PC software, like the AWA Corona?

**3.** Has it got at least 256 K bytes of memory like the AWA Corona?

**4.** Is the memory expandable beyond 512 K-bytes like the AWA Corona's?

**5.** Has it got a much sharper screen definition than the IBM PC? The AWA Corona has.

**6.** Can it take hard and floppy disks, as with the AWA Corona?

**7.** Is there a choice of desktop or portable model like the AWA Corona?

**8.** Can you buy the complete system for around \$5000? (The AWA Corona starts from around \$4500).

**9.** Does 'complete' mean the screen is included in the price, as with the AWA Corona?

**10.** Does it include the MS-DOS<sup>1</sup>, GW BASIC<sup>2</sup>, PC Tutor<sup>3</sup> and MultiMate<sup>4</sup> professional word processing system like the AWA Corona?

**11.** Is it fully backed and serviced by the company that supplies it to you, like the AWA Corona?

**12.** How quickly could you have one? Call AWA now.



SALES BY AWA

For more information write to: Corona PC Co-ordinator, (YC), AWA Computers, 132 Arthur Street, North Sydney, NSW 2060.

Name \_\_\_\_\_ Position \_\_\_\_\_

Company \_\_\_\_\_

Address \_\_\_\_\_

Postcode \_\_\_\_\_ Telephone \_\_\_\_\_



## AWA COMPUTERS

Phone: NSW: (02) 922 3300. VIC: (03) 529 4133. ACT: (062) 47 7522. QLD: (07) 359 3577. SA: (08) 333 2044. WA: (09) 321 9334. TAS: (002) 34 4532. AUCKLAND: 76 0129.

*The computer industry says 16-bit is the way to go, yet at the same time it keeps proving to us the eight-bit processor is far from dead. Evan McHugh finds AWA's new Z80 machine ample proof of the ongoing value of eight-bit technology.*

# AWA's THORN IN COMMODORE's SIDE?

AMERICA may be the place most people expect mass-market computers to come from, but the British have also produced a number of notable successes. Such machines as the BBC and the Sinclair range have presented an alternative that is often more competitive in price or performance than the gee-whiz technology from the US. Joining this illustrious field is the Amstrad CPC-464.

The Amstrad CPC-464 is a pretty bombproof piece of computer. It offers a Z-80 microprocessor, colour graphics, 64K of memory, room for expansion and no nasty surprises. The impression you get from it is of a straightforward, no-nonsense home computer with a good level of performance using proven technology.

A lot of people have been made to eat crow over processors like the Z-80 and the 6502. "Sixteen-bit will kill eight-bit!" they cried, as newer technology offered more power and greater speed. But it's been at a higher cost, and consequently few home computers have been able to get a foothold using 16-bit processors. People have found they don't need the extra power and can get complete satisfaction from a technology that is well supported by software aimed at

people with needs similar to theirs. Consequently, machines with 8-bit processors such as the Microbee, Apple, Commodore and BBC continue a prosperous existence. The Amstrad, definitely a latecomer, will have an uphill battle to get a foothold in the market, but the various extras it offers may tip the balance in a lot of people's minds.

## **The Guts of the Machine**

Built around the processor is 64K of RAM, of which around 42K is available for user programs. The rest is devoted to operating system memory requirements. One nice feature is that the screen RAM, which gives a maximum resolution of 640 by 200 pixels, is fully relocatable anywhere in memory.

A number of other hardware niceties come as standard with the Amstrad. The power supply is built in, unlike in many machines that expect you to tolerate ugly black boxes all over your work space. You also get a monitor as part of the package. Depending on your requirement you can opt for a green screen or a colour screen.

In choosing your screen there are a number of approaches you can

take. The first, which many people will probably go for, is the price approach: get the cheapie and make do. The green screen is certainly the choice for text-oriented activity. It gives a clear, crisp display of 80-column text which, by the way, is standard on the Amstrad. Where the colour monitor comes into its own is in colour graphics, especially in games. The colour is a little frazzled, but the low cost of the monitor perhaps excuses the fairly noticeable running-together of colour.

Another feature of the Amstrad is the built-in computer-operated tape recorder. Someone in the Amstrad marketing department took time from a cocktail party to give it the *tres amusant* title of 'datacoder.' This gives much more reliable loading of programs than normal cassette recorders, a definite plus for many users.

## **Peripherals**

It is possible to attach a pair of floppy disks to the CPC-464. These are the new 9 cm rigid floppies, and you have the option of either one or two. Naturally, because you are using floppies with a Z-80 you get the

## AMSTRAD CPC 464



CP/M 2.2 operating system when you buy the drives. This gives you access to the wide range of software available under CP/M including WordStar, communications packages and dBase. You probably wouldn't want to run a database on a machine like the Amstrad and I wasn't able to test one on our review machine, but word processing is a function many home buyers are looking for which would work well.

The slot for the floppy disk drives appears from some of the documentation to be also usable as a general- ▶



*. . . a straightforward, no-nonsense home computer with a good level of performance using proven technology . . . for someone who wants to mix games playing with serious applications, the Amstrad CPC-464 could be an ideal computer.*

# Electronics Today

## BOOK SALES

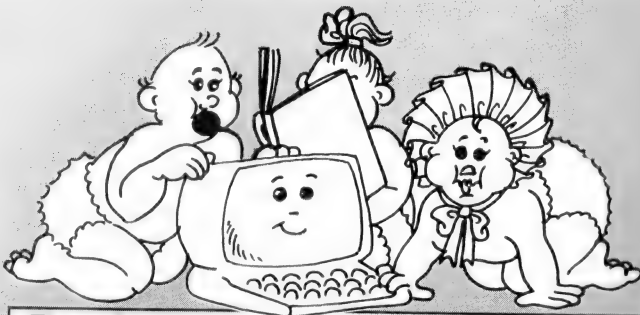

## Beginners Computing

Just starting? Choose one of these great titles. They make computing seem like child's play!

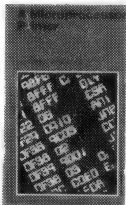

**PROGRAMMING FOR REAL BEGINNERS: BOOK 1**  
**H0344A** \$7.95  
 Written for complete beginners, this book assumes no previous knowledge of computing at all, and guides you gently through the initial stages of building up simple programs. The text is written to be non-machine-specific, and so can be used with any micro that is programmable in BASIC.

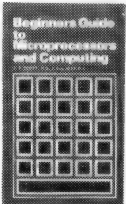

**PROGRAMMING FOR REAL BEGINNERS: BOOK 2**  
**H0387A** \$11.50  
 This book introduces you to the stages involved in planning a program, including the use of flowcharts, and explores the wider range of facilities the computer has to offer. You'll also learn how to plan your screen displays attractively to make your programs really user friendly.

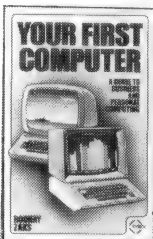

**YOUR FIRST COMPUTER**  
**H0271A** \$15.25  
 An easy-to-understand beginner's book to small computers. Understanding them, buying them and using them for personal and business applications.

**KIDS AND THE APPLE**  
**H0300P** \$25.75  
 How to write programs for the Apple computer, including action games, board games and word games.

**BEGINNER'S GUIDE TO MICROPROCESSORS AND COMPUTING**  
**H0143B** \$6.95  
 Introduction to basic theory and concepts of binary arithmetic, microprocessor operation and machine language programming. Only prior knowledge assumed is very basic arithmetic and an understanding of indices.

**A MICROPROCESSOR PRIMER**  
**H0144B** \$5.95  
 Learning about microprocessors is easy with this book, written in a style that is easy to follow. The shortcomings of this basic machine are discussed and the reader is shown how these are overcome by changes to the instruction set. Relative addressing, index registers follow as logical progressions.

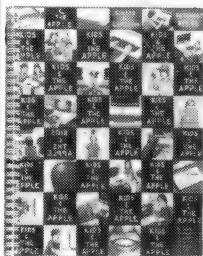

# Basic Electronics

Books that tackle electronics right from the beginning — what better place to start?

**INTRODUCTION TO AUTOMOTIVE SOLID-STATE ELECTRONICS**  
**A0015P** \$14.95  
 For the professional as well as the home mechanic — explains the functions of most on-board automotive black boxes and logic systems, including anti-skid braking, electronic spark control and diagnostic systems.



**BASIC ELECTRICITY/ELECTRONICS — VOL 2**  
**A0009P** \$15.95  
 Builds on the basic information in Volume 1 by giving detailed information on AC and DC circuits — covering series and parallel circuits, electro-magnetism, resistance, capacitors and inductance plus associated calculations.

**BASIC ELECTRICITY/ELECTRONICS — VOL 3**  
**A0010P** \$15.95  
 Valves and transistors, from an introduction to vacuum tube — through multi-element tubes, semiconductor devices, power supplies, amplifiers, oscillators, pulse circuits — to special semiconductor devices.

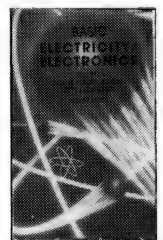

**BASIC ELECTRICITY/ELECTRONICS — VOL 4**  
**A0011P** \$15.95  
 Construction, operation and usage of electronic test instruments. Included are analogue and digital multimeters, vacuum-tube voltmeters, oscilloscopes, tube testers, bridge instruments and signal generators.

**ELEMENTS OF ELECTRONICS — BOOK 1**  
**A0003B** \$9.95  
 This five-book series is an introduction to modern electronics. All the maths is taught as the reader progresses. The course concentrates on the understanding of concepts central to electronics, rather than digressing over the whole field. The author anticipates where difficulties lie and guides the reader. Book 1 covers all fundamental theory necessary to full understanding of simple electronic circuits and components.

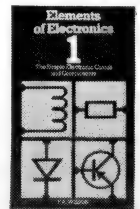

**ELEMENTS OF ELECTRONICS — BOOK 2**  
**A0004B** \$9.95  
 Alternating current theory — see Book 1.

**ELEMENTS OF ELECTRONICS — BOOK 3**  
**A0005B** \$9.95  
 Semiconductors technology leading to transistors and ICs — see Book 1.

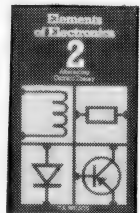

**ELEMENTS OF ELECTRONICS — BOOK 4**  
**A0006B** \$9.95  
 Microprocessing systems — see Book 1.

**ELEMENTS OF ELECTRONICS — BOOK 5**  
**A0007B** \$9.95  
 Communications — see Book 1.

Prices subject to change without notice

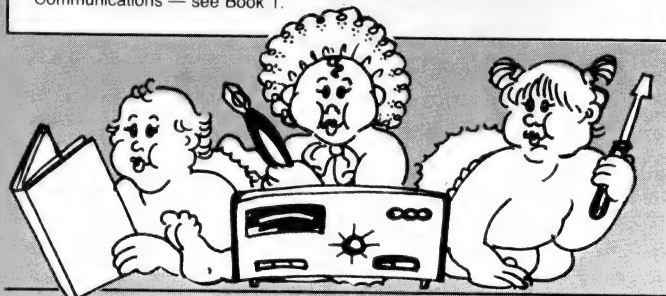

Simply fill out the reply-paid card insert and send to:

**ETI Book Sales,**  
**140 Joynton Ave, Waterloo NSW 2017**

All phone enquiries: (02) 663-9999, ext 242

## AMSTRAD CPC 464



purpose expansion port. The quote from the manual is a bit obscure, but for the record here's what it says: "Many hardware interfaces are available via jump blocks or indirection to provide software expansion facilities." The guy from the marketing department should have stayed at the cocktail party.

There is also expansion for a parallel printer and joysticks.

The keyboard on the Amstrad is quite good in some respects and a little disappointing in others. One of the trade-offs you get when putting the electronics under the keyboard is that, of necessity, the keys end up a long way above the desk. The only examples to have overcome this are the Microbee and the Sinclair range. On the Amstrad you may find you need a higher chair to reach the keys; they are a trifle higher even than the keys on the Commodore 64. This is a pity, because on a machine that will probably be used for word processing, that extra height could prove a strain on the typist.

When you do reach the keys, however, you find they are quite pleasant to use. The key travel is not long but the amount of pressure required to operate them is light and positive. They make a slightly tinny sound when pressed.

### Documentation

Just one manual is supplied with the

Amstrad, but it adequately introduces the machine and its BASIC. Special sections cover sound and graphics. Two others are sold separately and would be a requirement for the more sophisticated user.

The supplied manual, which is about 260 pages long, gives a lot of help to beginners and explains the way many of the machine's features can be used. This is done in a helpful, instructive style. Some of the instructions are not required in Australia, particularly those relating to putting power plugs on the cables from the equipment. In Britain they do not enjoy the same standardisation of wall plugs that exists in Australia, so the plug is fitted by the purchaser.

What the manual does not do is give instruction on the inner workings of the machine and how to get to them, which is why the other two manuals would be required by a serious hacker in order to do his or her own development on the machine. These extra manuals apparently offer a lot of information not readily supplied by other manufacturers, such as the routines involved in some of the BASIC commands.

### See no evil, hear no evil

Amstrad has obviously learned the lesson that any machine released for the home market must have good capabilities in the sound and graphics departments if it is going to succeed. The best evidence of the success of this philosophy in the Amstrad is its games. The best of the ones we looked at is 'Codeword Mat', which involved three-dimensional star battles as your craft flies through a star cloud. The spaceships grow large as they approach, the perspective rapidly changes from front to rear view and the stars converge or disperse evenly across the screen as you fly the ship.

While all this is going on, a number of voices from the sound chip make noises of the ship flying at various pitches, depending on speed, and imitate the sounds of firing your photon torpedoes and the crashes as your ship sustains a hit.

The graphics come in a number of modes. The first of these is 640 by 200 and lets you display two colours. Then there is a 160 by 200 screen that allows you to program every

point in any one of 16 colours, the 16 colours being selected from a total palette of 27 colours. A number of commands lets you create your own graphics, including a draw command for plotting and a window command for opening up to eight text windows and a graphics window on the screen.

Sound programming is well supported with a sound command, ENV (for envelope) command, and commands to control 'sound rendezvous' when using three voices.

### Software

Limited software is available for the Amstrad both on cassettes and floppy disks. More will probably become available depending on the amount of success the machines enjoys and the efforts made by the manufacturer to make available Amstrad-compatible CP/M software.

From the software that accompanied our review machine it seems the two main areas currently supported are games, which you would expect, and education software, which is a pleasant surprise. All of the software was of good quality, making efficient use of sound, graphics and the computational abilities of the machine. There was a limited amount of 'business' software aimed at the home, but there is no reason why some serious applications material could not be brought out for people who want to do a few 'real' jobs with a good low-cost computer.

The Amstrad is distributed and supported in Australia by AWA Thorn, whose marketing department should be able to tell you where your nearest dealer is if you contact them on (02) 638-8444.

The basic machine with a green-screen monitor will cost \$550, and the system with colour monitor goes for \$800. Add-on disk drives will set you back another \$400, and joysticks, games and educational software will cost about \$20 each. Given the price and performance of the machine it will certainly make a lot of sense to many people. The only reason it might not do well is its relative novelty on the Australian scene. However, for someone who wants to mix games playing with serious applications, the Amstrad CPC-464 could be an ideal computer. □

# SEGA-SUCCESS WITHOUT HYPE



*John Sands entered the home computer market quietly with its Sega computer – no fanfare, hype or outrageous promises. Matt Whelan discovered when he tried out the Sega that sometimes silence really is golden.*

JOHN SANDS' ENTRY into the computer market has been one of the 'cleanest' we've seen in a long time.

Instead of the usual huff and puff and promises, the company very quietly selected its product, formulated a marketing plan, and appeared in the marketplace with a very professional presentation.

The John Sands Sega looked good, and was sold well. It has become a successful product without the hype and price-cutting that seems to be hauling people into the home computer market and quickly spitting them out the other end.

The company is one of the few offering apparent stability and sobriety in the home computer market: witness the five-hour course offered free to every Sega buyer – the

company is obviously keen to bridge the knowledge gap that puts many home machines into the linen closet.

The John Sands approach is one most computer companies could do well to analyse and adopt. It is the sort of clear 'here today, here tomorrow' attitude that inspires consumer confidence.

The name John Sands helps – most Australians instantly recognise it, having been accustomed to buying board games and the like from this home entertainment market leader for years. Entering the computer market, with a games-orientated machine, was a natural step for the company.

### **The Best Laid Plans ...**

The one flaw in an otherwise excellent plan has been the Sega's 'orphan'

status. Like many machines, it didn't have the immediate software support to be all things to all people, as John Sands would have liked.

The company's brochures call it 'the total technology home computer system for education, personal business, fun and games', yet its price lists show a lot of games and educational software and very little of anything else. The clear suggestion that you keep *all* your important home business facts (insurance and mortgage details, bills, stamp collection and wine catalogues and so on) in your Sega isn't backed up by a significant selection of suitable software.

It's a problem most computer manufacturers face and, to be fair, it's one John Sands seems to be paying some attention. New software is appearing regularly, and several business-style applications have been announced in recent months. Disk-based software for word processing, spreadsheet and database applications were announced with the recent release of the Sega disk drive.

### **The Latest Sega**

The unit we tested was the SC3000H, the newest addition to the range. The 'H' stands for 'hard keyboard' – the standard SC3000 uses a touch-sensitive membrane keyboard, the new unit a standard typewriter-style set-up.

The SC3000 comes with 32 kilobytes of RAM (Random Access Memory) and 32K of ROM (Read-Only Memory). The 3000H gets 48K of RAM, and both are expandable to 80K.

The machine almost conforms to the recently introduced Microsoft MSX standard – it's "about 70 per cent MSX" according to John Sands. The other 30 per cent would have pushed



the price too high; it remains to be seen whether partial conformation to the standard will be of any use at all. Fortunately the machine stands well on its own, and has built up the sort of support the standard wouldn't give it until 1985 anyway.

Both machines run a 3.6 MHz Z80A processor, and have a 256 by 192 pixel graphics screen. Text output is 24 lines of 38 characters (upper and lower case). The unit generates 16 colours, and allows for a foreground and background graphics screen plus 32 graphics sprites. There are three independent sound channels, with a five-octave range.

The keyboard provides 64 keys in a standard QWERTY layout, with Graphic and 'Dieresis' keys providing access to special character sets and a Function key providing single keystroke access to 48 BASIC commands. All these extras are marked on the SC3000 keyboard, but not on the 3000H. A set of stick-on labels is provided with this unit if you want to know what every key can provide, but somehow we feel happier with the clean look of the standard keys. HOME, CLEAR, INSERT and DELETE keys are provided, as are four-way cursor control keys.

The Segas include a socket for cartridge software (or for connection of the 'Super Control Station' - more on that in a moment), a plotter/printer port, cassette I/O, and two ports for joysticks, lightpen or touch-pad. They provide RF output for connection to a television set, or composite video output for a monitor.

### The Add-Ons

The SF7000 Super Control Station (what's in a name?) is John Sands' newest option for the Sega. No, it's not a jetfighter cockpit for the latest ▶



Good graphics (above left) and sound make for fun games; so do accessories like the steering wheel control unit (above) and the joysticks (left). The larger unit is the new arcade-style joystick, a big improvement. The Super Control Station (below) adds a disk drive, memory, and I/O ports.



### SPECIFICATIONS AND REPORT CARD

Unit:	John Sands Sega SC3000H
Made by:	Sega Enterprises, Japan
Processor:	Z80A
Clock speed:	3.58 MHz
RAM:	48K
ROM:	32K
I/O:	Serial and parallel ports available
Languages:	BASIC
Keyboard:	Full typewriter-style QWERTY layout
Display:	24 lines by 38, 16 colours, 256 by 192 graphics
Expansion:	Disk drive, memory to 80K, ports, games controllers
Best points:	Graphics, games
Worst points:	The kids won't let us at it . . .

Ratings:	Excellent	Very Good	Good	Poor
Documentation:				•
Ease of use:	•			
Functionality:		•		
Support:		•		
Value for money:		•		
Options available:	Expansion unit, game controllers			
Extras included:	N/A			
Price:	\$349			
Review unit from:	John Sands Electronics, Frenchs Forest 2086. (02) 451-3555			

**AVERAGE  
MUSICIANS DON'T  
OWN A CX5M.**

**THAT'S WHY  
THEY'RE AVERAGE  
MUSICIANS.**

The Yamaha CX5M is an extremely versatile computer designed especially for musicians.

And especially for those musicians who are particularly serious about synthesised music.

Professional musicians, sound engineers, composers, arrangers and the like.

The CX5M is one of the new generation MSX computers, the very latest in software and hardware technology.

When connected to your DX7 synthesiser (other synths. subject to available software) the CX5M makes creating the sound you want and programming the sound you want considerably

easier. It can be used as a sequencer, edit suite, to compose pieces of music, or operate as a musical instrument independently.

In fact it has 46 synthesised voices already built in.

And all the voices are generated by the superb Yamaha FM system.

Complete with a 3 piece software package, the CX5M also features a built-in MIDI interface, which allows the computer to talk to any MIDI equipment such as synthesisers, drum machines, effects and sequencers.

And the regular arrival of new Yamaha



programmes ensure that its applications to your music are endless.

Of course, the real benefit of all this is that the Yamaha CX5M allows you more time to enjoy playing your music than wasting it programming your synthesisers.

It also converts to a standard computer on which you can play Space Invaders at the push of a button.

But we think that most musicians will use it with a different score in mind.

For more information about the Yamaha CX5M music computer, please fill in the coupon

below and send it to Rose Music, 17 Market Street, South Melbourne.

Yes, I would like to know more about the Yamaha CX5M.

Name.....

Address.....

Postcode.....

Saatchi Vic/RM 6235

**YAMAHA**



## Introducing the Smith-Corona Printers

Meet the Smith-Corona printers, 3 of the highest quality, yet reasonably priced printers, to meet your toughest demands.

With superior print quality and proven reliability backed with exceptional service and support, these dot matrix models are compatible with all business micros, PC and home computers and are fully compatible with **IBM** and **EPSON** printers.

**SPEED**-From 80 cps to 160 cps with bi-directional and logic-seeking features. **FLEXIBILITY**-Six pitches, up to 128 variations of type style and seven international character sets. **QUALITY**-Consistent high quality printing, true descenders, 160 cps draft, 40 cps NLQ, superb graphics capability too! **PRICE**-We believe the Smith-Corona has the best price performance of any machine in Australia, ring us and find out just how good they are.

### Smith-Corona Data Products

81 Regent Street  
Redfern 2016  
Ph: (02) 698 8211

IBM Trade Mark of International Business Machines  
EPSON Trade mark of Epson

SEGA

starblaster game: it's an expansion box with extra memory, ports, and a disk drive.

The SCS (we can't bring ourselves to say Super Control Station all day...) includes a 76 mm (three-inch) double-sided disk drive, which provides 312K of storage accessible through an extended disk BASIC.

It also provides RAM expansion to 80K. However, 45K of this is used by the disk operating system and BASIC interpreter, and 16K for the high-resolution graphics – leaving 19K available for BASIC programs.

The SCS has Centronics parallel and RS232 serial ports built-in to allow connection to a range of printers and peripherals such as modems.

At \$599 it seems an excellent-value option.

In fact, most of the Sega add-ons are well priced. The 'Data Recorder' may be a little steep at \$99, but it is a good unit with one particularly endearing feature: a piezo buzzer speaker lets you hear the program loading. It runs at 1200 baud, and has auto start/stop during save operations.

There is a four-colour plotter/printer available at \$329. Its transfer rate is 4800 baud, although that's academic at a 12 character-per-second print speed. Vertical plotting runs at 52 mm a second, horizontal at 73.

Other options include an 'arcade-style' joystick at \$27.50 and a steering wheel/accelerator unit at \$39.95.

**Sega Software**

Predictably, games feature strongly in the Sega software lists – although, more surprisingly, they are eclipsed by the amount of educational software available.

Many people buy home computers on the promise that it will 'help the kids learn', only to find out there is a painful shortage of software to do that job. It's another indication of the professionalism of John Sands' approach that it has more than 40 educational programs (many of them specifically Australian) in its catalogues.

We can't actually vouch for them – the John Sands people knew we'd prefer to re-run the East African Safari rather than learn to spell, so

they only provided us with games – but the range looks good.

It includes keyboard and typing tutors, BASIC tutorials, various straight maths, spelling, geography and general knowledge programs, plus a number of useful-looking educational games like Marauding Multiplication, Tank Addition, Satellite Subtraction, Demon Division and the Spycatcher Series.

Tape-based 'personal business' software includes Simple, which has 50 business, maths and statistical applications and includes a 297-page textbook, SOFTAX 1984, Mailing List, Expense Analyser and Segaword.

Virtually all the tape software retails for \$19.95 (Simple is an exception at \$59), while the games cartridges sell for \$39.95.

The examples we saw were generally excellent, making good use of the graphics and sound capabilities of the machine.

Another program to show off those capabilities is Vortex Blaster, the first in a locally written series which makes the Sega talk. The nicest thing about it is that it sounds as if it's digitised rather than the robot-like synthesised speech. Vortex Blaster doesn't use a big vocabulary – the most it can manage is 'red alert, red alert, Vortex Blaster' – but to our delight it says it clearly, in an Australian accent!

The Sega Level III BASIC is comprehensive, and makes good use of the machine's capabilities. It includes functions such as STICK and STRIG for joystick position and fire-button control, and graphics commands such as SCREEN, COLOR, PATTERN, POSITION, PSET, PRESET, LINE, BLINK, CIRCLE, BCIRCLE, PAINT, SPRITE, MAG, BEEP, and SOUND. There are VPOKE and VPEEK commands for working with the video display memory contents, and an HCOPY command for copying the screen to the printer.

**Should You Buy It?**

At a starting price of \$349, the SC3000H is a good machine, well worth a close look from anyone in the market for a home computer.

The fact that it has the obviously professional support of John Sands Electronics here makes it all the more attractive.

**SOFTWARE SPECIALS**

**Best Prices on IBM-PC Software**

PRODUCT	OUR PRICE
DBASE III	\$595
FRAMEWORK	\$595
SYMPHONY	\$725
WORDSTAR	
PROPAC	\$480
SUPERCALC 3	\$345
SMARTKEY	\$ 68
LOTUS 123	\$525
MULTIMATE	\$440
WORDPERFECT	\$480
OPEN ACCESS	\$650
RBASE	\$450
KNOWLEDGEMAN	\$525

*Epson Printers*

RX 80 FT	\$ 575
RX 100	\$ 750
FX 80	\$ 820
FX 100	\$1050
LQ 1500	\$1885

BANKCARD & MASTERCARD ACCEPTED

Prices include sales tax.

**FREE DELIVERY &**

**INSURANCE AUSTRALIA-WIDE.**

*Prices subject to change without notice.*

**THE SOFTWARE SPECIALISTS**

P.O. BOX 991, BONDI JUNCTION 2022

(02) 327 6759

(008) 22 1708 (Toll Free)

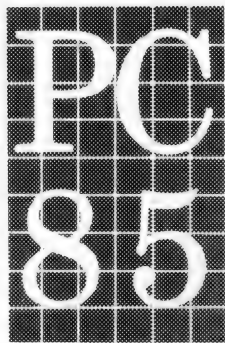

# The Conference

## Sydney 13th-15th March 1985

This will be the third successful Personal Computer Conference and is the definitive event in this field. Leading industry speakers will address the key issues of interest to you as a PC user, programmer or marketer. The program is literally crammed with information you simply cannot afford to miss!

Overseas speakers confirmed include:

Benjamin M. Rosen, Chairman of Compaq Computer Corporation  
Seymour Rubinstein, Chairman of Micropro International

Topics covered will include:

Managing PC's in the Corporate Environment  
Security and Protection of PC's  
Selecting PC's — The Real Issues  
Small User Experience  
System Development Aids  
Micro-Mainframe Connections  
Local Area Networks  
Dial-Up Networks  
Graphics  
The Software Shakeout  
Industry Directions and Trends

Last year's attendees said this about the PC 84 Conference:

"Well done . . . a worthwhile conference."

"Worthwhile . . . very enjoyable."

"All administrative aspects of the Conference were excellent, and ACS organisers most helpful."

". . . very informative and always interesting.  
Congratulations ACS."

### Registration Details:

Early Bird Registration  
(before 14th February)  
\$395

Normal Registration  
(after 14th February)  
\$450

Discounts apply for ACS members and for group bookings of three or more people — contact the ACS for details.

Organised by the Australian Computer Society, NSW Branch.  
1st Floor, 72 Pitt Street, Sydney NSW 2000.

Telephone (02) 233-7677.

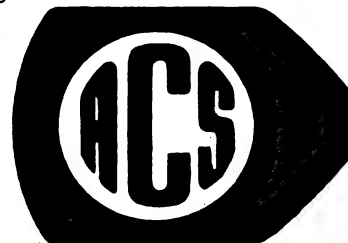

A LETTER has arrived from Imagineering, the distributor for Lotus, which says in part: "Unfortunately we cannot support the 1-2-3 package on the TI machine as we do not sell a version especially for it." This appears strange at first, because Imagineering has both Texas Instrument's TI Portable and TI Professional on its list of compatible computers.

To understand the position we have to look at the fine print in the 'disclaimer' in the front of the User's Manual, which includes the following statement:

"Lotus Development Corporation does not warrant that its 1-2-3 software package will function properly in every hardware/software environment. Lotus warrants only that 1-2-3 functions properly when used in combination with the hardware and software described in this User's Manual."

The manual I have says it is for "The IBM Personal Computer, the XT and the Compaq Portable Computer". Other versions have been produced by Lotus to run on other computers (Tandy, for example) and carry a similar disclaimer. TI has produced computers sufficiently similar to IBM's for the IBM version to run on them without change, but because for copyright reasons TI's computers aren't identical to IBM's, Lotus isn't going to take the risk that something won't work or that subsequent changes in the hardware or software will strike problems. This is understandable, even though it means you can get support on computers that differ widely from IBM's but can't get support on others that differ little.

Other compatibility problems may emerge with the introduction of new hardware and operating systems. I have heard a question raised about the compatibility of Symphony with the IBM 3270-PC, where there may be a conflict with Symphony's copy protection scheme. Another question will arise with the release of PC-DOS 3.0 and 3.1, although both 1-2-3 and Symphony are understood to work properly with the AT.

### Left-Labels

This useful Symphony command is buried at the end of a long string of choices. To get to it, the sequence required is Services Print Other Left-Labels. This command is used to print a spreadsheet where you have a number of headings in the first column

and wish to print only these headings and some other columns rather than the whole worksheet. An example is where you have a column for each month followed by an annual total; sometimes you may want to print only the headings

The manuals contain information on how to use this command but I found them totally incomprehensible; by contrast the Help screen is a masterpiece of brevity and clarity. Look them up, even if you don't have any immediate use for them; it's instructive to see the right and wrong way to convey information.

### Word Processing With Symphony

Recently I've been using two word processors. The first is an inexpensive job with limited formatting capabilities, although it does have a good spelling checker. It allows underlining, but not boldfacing or any other Epson options such as wide characters. The second is a full-functioned program that offers all the Epson features, but lacks a spelling checker.

How does Symphony compare with these two? In the first place, it doesn't have a spelling checker. Once you've used a good one they are very hard to do without. On the other hand, Symphony will allow you to use any features of your printer, such as bold, italic, underline, sub- and superscripts and strike-through, plus various combinations of these.

You use any of these printing attributes by specifying the start of the text you want to change (press the COMPOSE key), pressing the B key (for begin), and pressing the A key (for attribute). Then you enter an attribute code - B for bold, I for italic, U for underline, + and - for super- and subscripts, and X for strike-through. That's straightforward, but combinations are indicated by numbers in a 0 to 9 sequence, so you're unlikely to memorize them unless you use them a lot. You indicate the end of the text by positioning the cursor at the end of it, pressing the COMPOSE key, pressing the E key (for end), and pressing the A key (for attribute). What a slow and cumbersome process!

On the screen, the attributes appear as an up arrowhead, followed by the print attribute code, then the text and then a down arrowhead. There is no way of suppressing the display of the print attribute codes.

Come on, Lotus, you have to be joking! The second word processor I referred to above has been on the market for some time, and it provides on-screen underlining and boldface on a monochrome monitor, and each attribute in a different colour on a colour monitor. Attribute codes are normally suppressed, but can be displayed at any time. Each attribute uses a two-character code with the first always being the same. The ease of using this system is why I am typing this using the word processor instead of Symphony.

### Other User Groups

Members of the Lotus users' groups should be aware of the existence of PC users' groups. The meetings in Sydney are at the same place as the meetings of the Lotus Users' Group (Deloitte Haskins & Sells, 7th floor, 18 Bent St) and are held between 5.45 and 8.00 pm on the third Monday of every month. For information on groups in other States, the contact names and phone numbers are:

Adelaide Don Richards (08) 261 9590  
Melbourne Roy Watson (03) 211 7523  
Perth Tony Farrell (09) 320 8245

### Slow Recalculations

Imagineering has provided us with a copy of 'Common Questions and Answers' from the U.S. Lotus Computer Support Department. One question that will have puzzled a lot of us is this one:

Q: When I design a large worksheet, the recalculation slows down considerably. Is there anything I can do to speed things up?

A: Switch to manual recalculation and your problems will be solved. The correct keystrokes (in 1-2-3) are /WGRM. This will suppress recalculation until the user hits the F9 key.

When you are using manual recalculation, 1-2-3 warns you by displaying a CALC prompt on the screen until you have performed the recalculations. If you want to be notified when the recalculation has finished, follow the CALC instruction with some keystrokes like <Home>, <Up> and <Up>. When the recalculation is finished, these keystrokes will be read and will produce two beeps from the computer. You can enter these keystrokes manually or include them in a macro. □

**SPECIAL SERVICE**  
TO  
**your computer**  
READERS



**24 HR 365 DAY A YEAR SHOPPING**

If its for  
**COMMODORE** or  
**ATARI** Computers  
and in  
**your computer**  
magazine

IT IS GENERALLY  
AVAILABLE THROUGH

**(008) 777 130**

(STD at the price of a local call  
anywhere in AUSTRALIA)

**JUST RING NOW AND  
ORDER IT. WHY WAIT  
TILL THE SHOPS OPEN?**

If you don't know the price give  
us a limit and we will notify you if  
your order is in excess of that limit,  
or product availability etc.



**THE VIC CENTRE**  
416 LOGAN ROAD, STONES CORNER, QLD. 4120  
TELEX. 40811 PO BOX 18, STONES CORNER 4120  
Local and enquiries (07) 397 0888.



**Prize  
winning  
software  
from**

**AWARD**



**Convert any  
CP/M to DOS with  
CROSSDATA™**

Crossdata is the low-cost utility software that  
converts data/text file formats from CP/M to  
MS/PC-DOS and back again on any IBM PC/XT or  
clone.

It is a self-contained program, ready to run, that  
reads/writes CP/M and MS/PC DOS Diskettes using  
MS/PC-DOS 2.0, 2.1 or 3.0 and comes with 28  
formats — plus you can add your own!  
Solve your computer incompatibility problems  
fast with **Crossdata**, the proven conversion  
package, by ordering one today for only \$149.

**Keep Your Computer Fit With  
CROSS-CHEX™**

**Cross-Chex** is the complete menu-driven system of  
hardware diagnostics. It analyses performance  
levels of Winchester and floppy disk drives, video  
display, RAM memory, video memory, ROM  
character generator and keyboard. Includes (1)  
Diagnostic Diskette (1) **Cross-Chex** Program  
Diskette (1) Users Manual. Let **Cross-Chex** keep  
your computer fit, ensure the performance of your  
computer, maximise your uptime and maintain the  
integrity of your data all for the low price of \$149.

**Backup/Restore for Winchester under  
PC/MS-DOS, CP/M86 and CCPM with  
CROSSAVE™**

Now you can back-up large data base files from a  
Winchester to a floppy for files that exceed the  
diskette capacity.  
**Crossave** will save and/or restore a file or a  
selected group of files that have been updated. It  
also backs up and restores all of the files on the  
Winchester. It uses compression to reduce storage  
space requirements on the floppy and expands the  
file upon restoration. Requires IBM PC/XT or clone.  
Reasonably priced at \$149.

**No risk 10-day money back  
guarantee on all products**

**Don't delay. Call us today:**

(09) 322 6654 or write:



**AWARD  
SOFTWARE  
AUSTRALIA**

90 KING ST, PERTH  
WESTERN AUSTRALIA 6000  
TELEX AA 92547

All major credit cards accepted

**Microbee  
HACKER'S  
HANDBOOK**

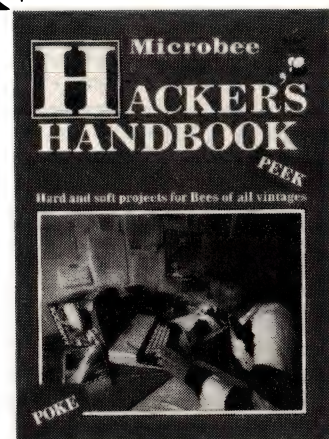

From the publishers  
of 'ETI' and 'Your  
Computer' magazines.

**The Microbee Hackers Handbook  
will tell you how to:**

- Get more from the Bee's graphics capabilities.
- Set up for telecommunications on the Bee.
- Play music on the Bee.
- Build a joystick and a light pen for the Bee.
- Get hardcopy — cheaply.
- Expand your 16K Bee to 32K
- Make the Bee a better games machine.
- Turn your Bee into a facsimile decoder.
- Solve equations on the Bee ... and much more!

**\$6.50 at your newsagent now.**

# HARD DISK MICRO DECISIONS: MD11



The MD11 offers a carefully selected group of business application software including word processing, forecasting, data base management and accounting functions — the MD11 speeds you through them all, even if you've never used a computer before. The Micro Decision's straight-forward component design insures continued reliability.



**MORROW BUSINESS SYSTEMS COME WITH:  
2x400K FLOPPIES, OR  
1x400K FLOPPY AND 5, 11, 16 OR 34 MB HARD DISK.**



## THE BUSINESS ACCOUNTING PACKAGE INCLUDES:

### GENERAL LEDGER SYSTEM SYSTEM OBJECTIVES

1. To control:
  - A. Company
  - B. Partnerships
  - C. Sole Trader
2. To compare results with budget and last year.
3. To produce the financial reports.
  1. Manufacturing
  2. Trading
  3. Profit and Loss
  4. Balance Sheet
4. To transfer the totals from the various ledgers, Debtors, Creditors sales etc.

### DEBTORS SYSTEM SYSTEM OBJECTIVES

1. Integrated with Invoicing/Stock.
2. Automatic Production of Statements.
3. Debtors Control by Aged Trial Balance.
4. Analysis of Sales Monthly & Yearly.
5. Analysis of Sales by Area/Salesman.
6. Calculate Salesman's Commission.
7. Uses Standard Stationery.

### INVOICING/STOCK SYSTEM SYSTEM OBJECTIVES

1. To maintain and control stock inventory levels.
2. To produce a detailed invoice or Credit No. on-line.
3. To analyse the sales and profitability of all stock lines.
4. To produce a complete sales tax analysis.
5. To integrate with the Debtors system and update account balances at invoice stage.
6. To produce salesman and area figures including a commission statement.

### CREDITORS SYSTEM SYSTEM OBJECTIVES

1. To produce a creditors system which can operate: Integrated with the Stock System.
2. To maintain and control the Accounts Payable section of a company.
3. To control discount available.
4. To make payments to selected creditors by the use of the aged Trial Balance.
5. To produce cheques automatically.
6. To analyse purchases from creditors month and year to date.
7. To produce the necessary totals to transfer to the General Ledger.

**LEASE FROM \$25 WEEKLY.**

## **AUTOMATION STATHAM Pty Ltd**

**47 BIRCH STREET, BANKSTOWN,  
NSW, 2200. (02)709-4144  
TLXAA 73316**

**COMPETRON**  
252 Abbotsford Rd,  
Mayne, QLD 4006  
(07)52-9522

**A FULL SERVICE MORROW DISTRIBUTOR SINCE 1976**

**ASSCO Pty Ltd**  
17 Heatherdale Rd,  
Ringwood, VIC 3134  
(03) 873-2266

# COME FLY WITH ME!

*Frank (Biggles) Lee dons his leather helmet, scarf and goggles to test-pilot the latest version of Microsoft's Flight Simulator.*

The Microsoft Flight Simulator has become something of a touchstone for assessing IBM PC compatibility. However, as a flight simulator, the original version had a few shortcomings.

Briefly, it would not show colour on an RGB monitor, nor could it make use of a joystick. The lack of RGB colour and the unreality of flying with a keyboard eventually deterred me from buying a copy of the Simulator; hence the wish list. And hence my glee when Microsoft Australia (dressed up as a Wish-List Fairy) rang to see if I'd be interested in reviewing the new version. So here's the review.

## Presentation

The product comes in a slim 20 cm square box. The marketing people have done a good job in ensuring that a casual perusal of the product would help to convince the shopper that the recommended retail price of \$87.95 (less if you shop around) is well worth it.

The box explains that this is a 'real-time' flight simulation that puts you in the cockpit of a Cessna 182 – a rather nippy little high-wing sports craft. It has out-of-the-window views that closely resemble a pilot's perspective. It further explains that you can land and take off from more than 80 airports, alter the weather, time of day, season, and level of realism. It also supports optional joysticks (up to two) and the Microsoft Mouse. "Both provide better control of your instruments than you get with the keyboard. And when you're fighting everything from high winds to enemy aircraft,

you're going to need it."

You will need an IBM PC (or a 'real' clone, like my President 16) with a minimum of 64K of memory (who'd have less?), one disk drive, and a colour graphics card. If you want to use the mouse you'll need 128K of memory. It also runs on the PCjr.

Inside the box is a most comprehensive spiral-bound manual, complete with area maps and a 13 cm disk.

## Documentation

In spite of the 'game' nature of the external presentation, it quickly becomes apparent that this is much more serious an enterprise than your average take off, mess around and land simulator. For a start, you are referred to a bunch of dead-serious publications such as the FAA Flight Training Handbook and Instrumentation Flying Handbook.

Naturally, you'll be anxious to get airborne as quickly as possible. You can skip to the section headed 'Flying Start', which takes you through a quick test flight. You'll get airborne, but getting back safe and sound is quite another matter.

The manual is divided into four main sections: Learning the Flight Simulator, Using the Flight Simulator, World War I Ace, and a comprehensive reference section. The reference section includes the detailed area charts, performance specifications, a glossary and index. To put it briefly, this manual is excellent.

If you really want to delve into the subject properly you should consult

the Australian equivalent of the texts recommended in the manual, or discuss it with a flight training school.

## Getting Started

The Simulator's world consists of the entire continental USA and extends into Canada, Mexico and the Caribbean. The 'populated' world consists of four areas, and includes more than 20 detailed airports for which charts are included.

You can select 'easy flight mode' (for beginners like us), or 'reality flight mode' for masochistic experts who want to battle the elements. In this latter mode you can select a level of reliability to determine the frequency with which problems arise in flight.

The program disk contains two versions of the Simulator, one for the regular IBM PC, the other for the PCjr. They are functionally the same, but use different keyboard sequences. Since my machine is essentially an IBM XT+ with an RGB monitor, we'll be using the PC version. Here we go.

We load the program disk into drive A, then boot the system as usual. The screen displays a three-option menu asking what display is being used (colour TV, B/W TV or monitor, or RGB monitor). We select the RGB monitor. The next screen gives these three options:

- A. Demo Mode
- B. Regular Flight Mode
- C. Disk Back-up

Of course the only correct option is C. But since we are as impatient as blazes we go for A. After this selection, the third and last menu lets us identify the keyboard (PC or PCjr). We then sit back and watch the demo, hoping that a power glitch doesn't clobber the disk before we have a chance to do a back-up. Fascinating. A regular take-off, views

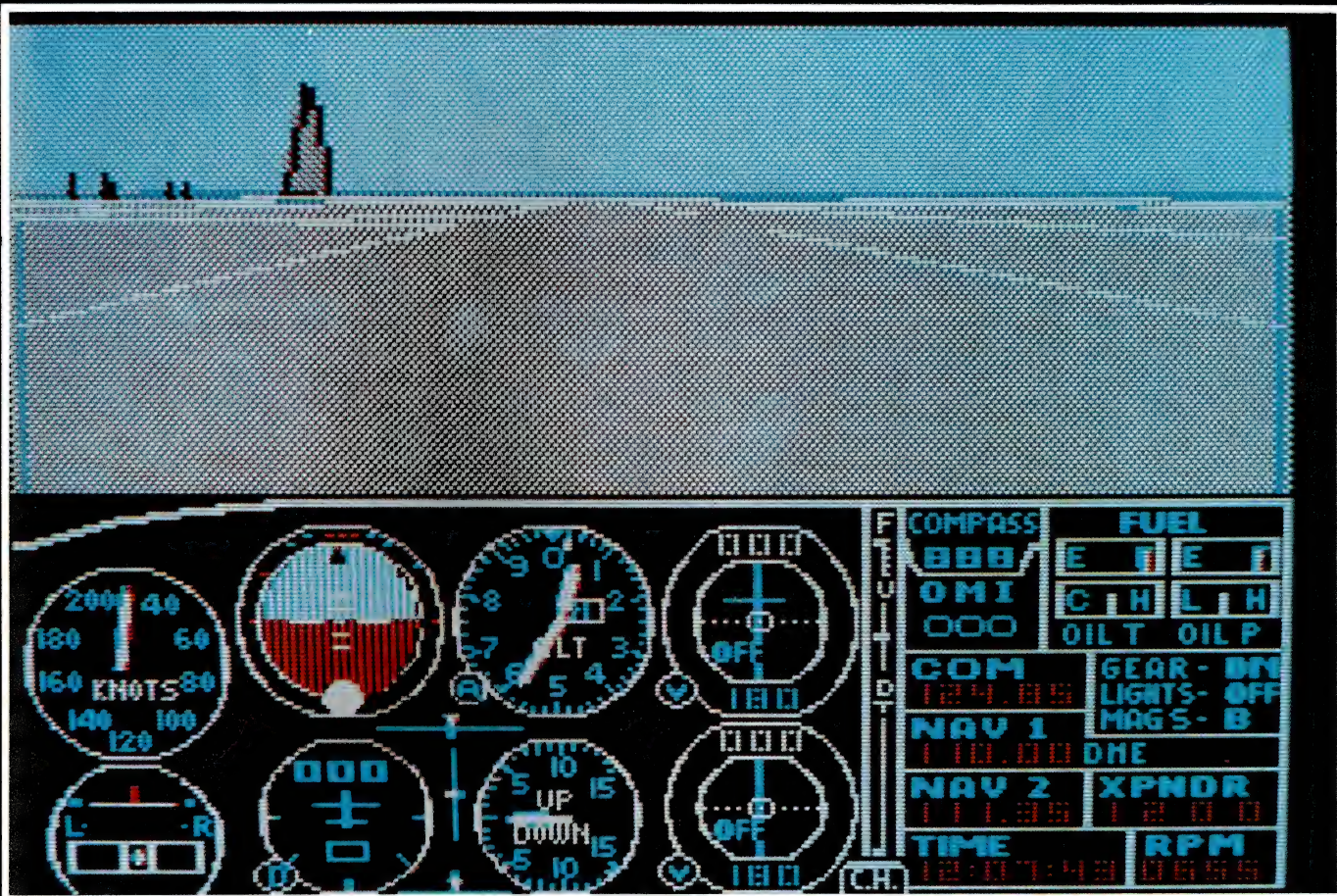

Figure 1. The initial screen in regular flight mode. See text for description of the instruments.



A view from the rear of the plane as it takes off



A straight-down radar view of the ground near Meigs Field.

from the front, rear, sides and even below as we skim the landscape.

Fear finally wins out, so we reboot the system and select the Disk Back-up option (as we should have in the first place).

You can make just one back-up copy of the Simulator disk. The copy process assumes that you only have one disk drive, so it gets a wee bit tedious flipping the disks in and out.

If your computer has a game adapter card then you may use one

or two joysticks. The ideal set-up is to use one joystick as the 'normal' stick, with the other controlling the throttle. I would encourage anyone who buys this program to invest just a little bit more on the joysticks; it's well worth the extra.

### Flying Free

Here's what happens when flying with the keyboard. The primary controls include the 'control yoke', rudder pedals and throttle. The control yoke

is represented by the arrow keys on the PC's numeric keypad. In the initial flight mode, the rudder and ailerons are 'tethered' to ensure that you don't side-slip while doing a turn. In a real Cessna you have to co-ordinate the rudder and ailerons to execute a comfortable turn. The function keys control the throttle and flaps.

Your vision is not restricted to straight out the front of the aircraft; you can observe in nine different

# IT'S ON AGAIN!

FROM PARTICIPATING DEALERS:  
SUITS APPLE II, IIc, IIe, III,  
IBM PC AND LOOKALIKES.  
(ASK FOR HARDWARE CONFIG. DETAILS)

## SIX'S' SOFTWARE 6-PACK

### THE 6S SOFTWARE 6-PACK INCLUDES

- **DEBTORS** with sales analysis and comprehensive reports
- **INVOICING** with automatic pricing and full integration to Debtors/Inventory ledgers.
- **INVENTORY** with sales and profitability analysis - auto buying levels
- **CREDITORS** open item, with complete automatic G/L integration
- **GENERAL LEDGER** with automatic balancing and double-entry
- **PAYROLL** with pay slips, group certificates, automatic taxing and holiday pays.

**GIVE YOUR COMPUTER WHAT IT WANTS  
- AND WHAT YOU NEED!**

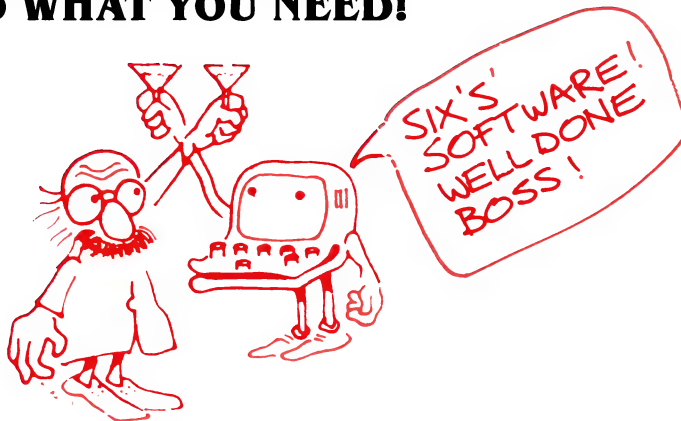

GET ME  
SOME GOOD  
BUSINESS  
SOFTWARE



# \$1195

NORMAL RETAIL VALUE OF THIS SOFTWARE  
PACKAGE \$2130

Plus  
Special  
Offer

To further enhance the value of the 6-pack: You can receive **ABSOLUTELY FREE** the incredible

- **ASK:** Accounting Scenario Key Program for business analysis
- **TELL:** A powerful, effective word processor.

ONLY APPLICABLE TO SUITABLE HARDWARE

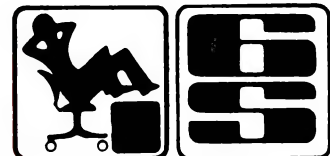

## SOFTWARE

Six "S" Business Advisory Pty. Ltd.  
1st. floor, 39 Gheringhap Street,  
Geelong, Victoria 3220  
P.O. Box 1220  
Telephone (052) 22 4311

**PROVEN, GUARANTEED, SUPPORTED**

Y/C

directions if you press the Scroll Lock key followed by one of the numeric keys 1 to 9. The 5 key lets you look straight down, while the 2 key gives you a great view of the rear as you take off from the runway; you'll even see the rudder as you look back. This Cessna also has a zoom radar! You select radar with the Num Lock key then use the + and - keys to zoom in or out. Press the Scroll Lock and a numeric key to return to the normal three-dimensional display.

The manual details the other 'fancy' controls such as elevator trim, carburettor heat, magnetos, mixture, and lights.

Figure 1 shows the initial screen, which is split into two sections. The upper portion presents a pilot's eye view of the world outside: here we see the runway, a tower and the horizon. On clear days you get a blue sky; cloudy days have a grey sky, which also obscures ground details. Radio messages may also scroll across the screen from time to time to provide airport and weather information.

The lower section displays the instrument panel and the radio stack, while the six primary flight instruments are grouped together at the left of the display. The remaining pair of instruments are both omni-bearing indicators used in instrument approaches.

The remaining indicators are a magnetic compass, fuel gauges, elevator trim setting, throttle position, carburettor heat indicator, marker indicator lights (for instrument landing system), flap angle indicator, oil temperature and pressure, status lamps for landing gear, lights and magnetos, carburettor heater indicator, and radio/navigational settings. A very comprehensive array! But be not dismayed. You can fly (in good conditions) with just a compass and an air speed indicator (so you don't go too slow and drop out of the sky).

The manual gives an excellent description of each of these indicators and controls.

When the program is started, you are facing due north on the runway at Meigs Field (a small field on a peninsula on Lake Michigan) in Chicago. You can see the John Hancock building on the horizon to the north west, and you will take off

```

Environmental and Peripheral Control
Time: Hours - - - - -> 12
      Minutes - - - - -> 28
Season - - - - -> 2
Cloud layer 2 tops - - - - -> 0000
Cloud layer 2 bottoms - - - - -> 0000
Cloud layer 1 tops - - - - -> 0000
Cloud layer 1 bottoms - - - - -> 0000
Wind level 3: knots - - - - -> 0000
              degrees - - - - -> 0000
Shear zone altitude 3 - - - - -> 9000
Wind level 2: knots - - - - -> 0000
              degrees - - - - -> 0000
Shear zone altitude 2 - - - - -> 6000
Wind level 1: knots - - - - -> 0000
              degrees - - - - -> 0000
Shear zone altitude 1 - - - - -> 3000
Surface wind: knots - - - - -> 0000
              degrees - - - - -> 0000

Reliability factor - - - - -> 100
Joystick (0, 1, or 2) - - - - -> 0

-----
Mrs Edit Mode pg.2 Hit esc to exit
  
```

```

Simulation Control
User mode - - - - -> 0
Sound - - - - -> 1
Auto-coordination - - - - -> 1
Slew - - - - -> 0
Reality mode - - - - -> 0
Demonstration mode - - - - -> 0
Europe 1917 - - - - -> 0
Communication rate - - - - -> 192

Aircraft Position
North position - - - - -> 17188
East position - - - - -> 16671
Altitude - - - - -> 591
Pitch - - - - -> 0000
Bank - - - - -> 0000
Heading - - - - -> 0000
Airspeed - - - - -> 0000
Throttle - - - - -> 0000
Rudder - - - - -> 32767
Ailerons - - - - -> 32767
Flaps - - - - -> 0
Elevators - - - - -> 32767

-----
Mrs Edit Mode pg.1 Hit esc to exit
  
```

Figure 2. The two editor pages. The editor mode is entered at any time by pressing the Escape key.

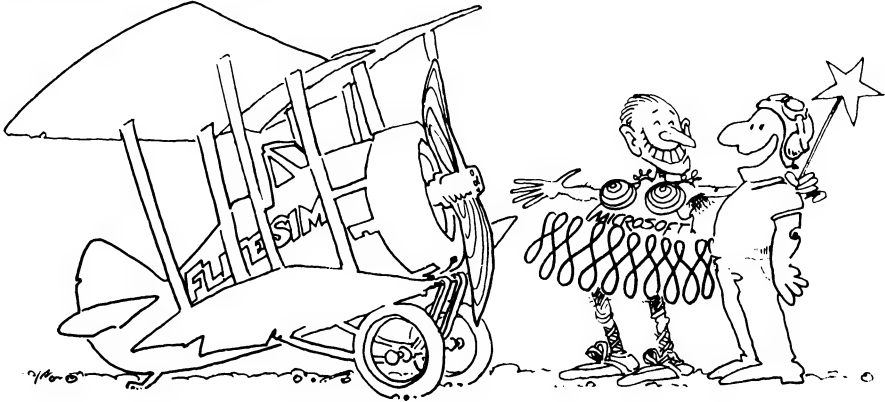

# G-PASCAL

## for Commodore 64

G-Pascal is a program development system for your Commodore 64 that incorporates a high-speed compiler for a subset of the popular structured Pascal language.

G-Pascal has many extensions that support features of the Commodore 64 such as sprites, graphics and sound effects.

G-Pascal is available on disk or cassette and is supplied with an 80-page User Manual which includes a tutorial on Pascal.

G-Pascal may be purchased direct from Gambit Games - cheques, postal orders and major credit cards accepted, or see your local dealer. Recommended retail price: \$79.50. Please phone or write for a brochure (no stamp required):

Freepost 124Y,

**Gambit Games**

P.O. Box 124, Ivanhoe VIC 3079

Phone: (03) 497 1283



**Cairns means hassle-free living.**

**So does our software!**

**FOR NEC-APC, HITACHI,**

**MB16001, MB6809**

- |                         |           |
|-------------------------|-----------|
| * Video Library         | * Finance |
| * Insurance Agent       | Debtors   |
| * Insurance Broker      | Creditors |
| * Aviation Management   | Ledger    |
| * Motel Management      | Stock     |
| * Restaurant Management | Job cost  |
| * Produce buy/sell      | Payroll   |

**CYPHER RESEARCH LABS.**

**P.O. BOX 4, MACHANS BEACH 4871**

**PHONE: 55 9138**

# BACKUP YOUR DISKS

**\$98.95**

plus \$2.00 postage & packaging

EDD is the most powerful disk duplicator available for your Apple™ computer. Unlike the Copycards, which only copy single load programs, EDD backs up your entire disk. EDD can back up more protected software than all other copy programs or Copycards put together. Since EDD is automatic, you will no longer have to change parameters to duplicate most disks, although every parameter is fully documented in our extensive manual. We also provide updated EDD program lists.

EDD runs on Apple II, II+ (including most compatibles), IIc, IIe and III (in emulation mode), with one or two 3.3 disk drives.

## ESSENTIAL DATA DUPLICATOR III™

- EDD rarely needs parameter changing.
- Automatically finds the beginning of each track.
- Unlike any of the Copycards; EDD backs up the entire disk — not just what is in memory.
- Accurately finds "auto-sync" bytes and their lengths.
- Can copy 1/4 and 3/4 tracks.

Order by phone

To order your copy send Cheque or Money Order to:

**UTILICO SOFTWARE**

**83 Hall Street, Bondi Beach, NSW 2026**

**Telephone: (02) 30-2105**



# WITH TANDON DRIVES YOUR COSTS

GO  
O  
W  
N



- \* Genuine world leading Tandon drives — not cheap copies
- \* Fully warranted and serviced by sole Australian agents
- \* Plug 'em in and run! Models to suit TRS-80, Apple II, IBM PC & XT, CAT, Challenger, & S100 systems. New models are being added regularly.

Floppies bare and encased — call for price

- \* Winchester Systems to 30MB — low, low prices \*
- IBM compatible hard disk systems to 30MB are 100 % compatible with the PC & XT
- Apple compatible hard disk systems support DOS, CP/M and Pascal on one disk

B\*CARD, VISA & AMEX WELCOME. ALL DRIVES SUPPLIED COMPLETE WITH CASE, CABLES & MANUALS SOFTWARE SUPPORTS POWER SUPPLY AS REQUIRED.

**CALL MICRO GENERAL (02) 398 8601**

**FOR THESE SPECIAL DEALS NOW!**

TELEX AA135042 "ATTN MICANGEN"

TRADE ENQUIRIES WELCOME

and climb over Lake Michigan. It's a clear day, there are no winds, and it's perfect weather for VFR (Visual Flight Rules) flying. If you mess this up, you're a crumb. The manual will tell you exactly how to taxi and get airborne for an easy flight. It also gives a careful explanation of getting back down onto the ground.

### Greater Things

The real fun of this simulator is navigation, once you've mastered the principles of regular (easy) flight. The editor lets you change many environmental factors, and provides for realistic flight conditions with varying degrees of difficulty.

I'd love to tell you more about the navigational systems in the Simulator; they're great. But this is a short review, not a flight manual (although it's heading that way). Here we will just summarise the remaining goodies.

Figure 2 shows the two pages of the editor system (which pops up when you hit the escape key). Entering the editor suspends the simulation until you return by pressing the escape key again. With the editor, you may reset a wide range of operational parameters. The first editor option allows the selection of a 'user mode' in the range 0 to 29. Modes 0 to 9 are preset, and each corresponds to a particular set of values for the remaining editor options. Mode 0, for example, is for 'easy flight' conditions at Meigs Field; mode 5 is for moderate weather at New York. You can create your own set of modes and save them on a 'mode disk' if you wish.

If you select a non-zero value for 'slew', you can zip around your 'world' at unrealistic speeds while viewing the terrain. You might want to do this for a trans-continental trip lasting several hours at normal air speeds. It's a bit like having a Star Trek hyper-drive system.

Reality mode is not for beginners. If you select this mode, all sorts of nasty situations can jump out at you, like getting stuck in a snow bank if you leave the runway. Your carburettor may ice up on a humid day, and lots of other unpleasant surprises.

Demonstration mode activates a demonstration in which the plane flies itself for 40 minutes.

Europe 1917 sets up the World War I Ace aerial battle game, much like the original Apple version by the same author. I'll say little about this, since Number One Son is the current expert on war games.

The communication rate controls the rate at which information messages scroll across the top of the screen.

The editor lets you reposition the aircraft and readjust its attitude. Your north and east positions define the aircraft's map co-ordinates in units of 256 metres relative to an arbitrary origin. Any of the attitude values (altitude, pitch, bank and heading) may be changed, as well as the settings of your control surfaces.

The second editor page is used to reset the environment and selection of peripherals. Unfortunately, there is no provision for a hard copy printout. That would have been very useful for this article. Instead, we had to photograph the screen.

### Advanced Flight Techniques

Under this section, the manual details the finer points of 'unco-ordinated' flight, in which you must control the rudder and ailerons separately as in a real Cessna. Manoeuvres are also discussed. I managed to survive a couple of inside loops, but crashed while doing a barrel roll.

A section entitled Navigational Aids is a good introduction to the use of VOR (Very high-frequency Omni-directional Range) navigation. The Simulator includes ILS (Instrument Landing System) approaches, and OMI (Outer, Middle and Inner) marker beacons and glideslope for landing blind. The provision of two 'omni' indicators allows one to determine your exact position relative to two known beacons. Finally, the DME (Distance Measuring Equipment) associated with the VOR gives you a direct readout of your distance (in nautical miles) from the VOR beacon to which you are tuned.

This, briefly, is an excellent program. If you are not already into flying, it will tempt you to give the real thing a go. On the other hand, this simulator is dirt cheap compared to the real thing - and a darn sight safer.

Sorry, gotta rush. Writing this article has taken too much time away from battling the elements. Hang on there, Red Baron, I'm coming. □



# dBASE II<sup>®</sup> VIDEO COURSE by Adam Green

"THE PROFESSOR OF  
dBASE IN USA"  
AND AUTHOR OF  
dBASE II™ USER'S GUIDE

- \* NINE SEPARATE LEARNING MODULES
- \* EMPHASIS ON CONCEPTS
- \* NOT A TAPED LECTURE
- \* A COMPLETE PACKAGE

3 HOUR VIDEO TAPE  
WITH CLASS NOTES

**\$395**

*(three dent env. if ordered in November)*

USED BY MANY COMPUTER  
MANUFACTURERS, GOVERNMENT  
DEPARTMENTS & COMPANIES  
ASK FOR LIST OF USERS

SAVE TIME AND MONEY  
**ORDER TODAY**  
SOLE AGENTS

**AID**

SYSTEMS (PTY) LTD

14 Cecil Street Gordon 2072  
Telephone (02) 498 7428  
Telex AA23976 AID

When it comes to unquestionable experimental proof, there is more evidence to support Murphy's Law than the rest of the natural laws put together (I once heard a naive soul try to refute this, but of course he wasn't a programmer). No matter what sort of logical armourplating you build in, around and all over your programs, there will always be the illogical idiot or incomprehensibly incompetent button basher to circumvent any kind of protection against invalid inputs you might try to foresee.

Stupidity isn't restricted to the stupid, of course, and late nights can wreak havoc with an otherwise reasonably reliable brain. My wife had to pull someone through a bad emotional period recently after he had formatted his favourite utility disk (not backed up for three busy months) after 11.45 pm and 50 lines of random access file fiddles. Still, good programmers do their best to help users, and you might be pleased to know that the BBC has a perfect software defence against any kind of interference from the keyboard. Then again, try \*FX201,1 and you might not be so pleased.

A less drastic method of making sure you don't have programs trying to do strange and wonderful things is to restrict the use of INPUT. The problem with INPUT is that users are free to type in 255 characters before the machine objects. (If you think no-one would type in a 255-character response to a yes/no question, you haven't seen a team of over-confident Year 5 students in action.) The secret is to decide *exactly* what is acceptable and design the program to ignore anything else.

For example, if you want a yes/no answer, use the simple defence:

```
1000 REPEAT: A$=GET$: UNTIL
A$="Y" OR A$="y" OR A$="N" OR
A$="n"
```

```
or
1000 REPEAT: A%=GET AND &5F:
UNTIL A%=78 OR A%=89
```

which is more elegant way of doing the same thing. Numbers can be specified so that only a limited number of digits can be entered. A menu needing a choice like -2345.67 isn't exactly an everyday occurrence! Most need one or two digits. Further keystrokes should be rejected until either RETURN or DELETE is pressed. If you code it you'll find it could run to ten or fifteen lines, and if this seems like an unpleasant al-

ternative to using the INPUT statement, you'll have to ask yourself whether the programmer or the user is more important.

Similarly, you should make sure that requests for names reject digits, full-stops, commas, and so on, but not hyphens or spaces; it defies the imagination to try and predict the depths of despair plumbed by the Honourable Fortescue Fyffe-Cholmondeley if rejected by the BBC!

Two other delightful features of the Beeb are the INKEY(n) and INKEY\$(n) functions, which place a time limit on the user to answer.

```
3000 PRINT "Press zero"
3010 A$=INKEY$(100)
3020 IF A$="" THEN PRINT "Too
slow." ELSE IF A$<>"0" THEN PRINT
"No, that was ";A$ ELSE PRINT "That's
it."
```

Line 3010 allows one second to reply. By changing 100 to 250 the user would be allowed 2.5 seconds. INKEY\$(12000) would allow two minutes. Carefully used, these could abort a program if the machine was unattended, saving any necessary data to disk and allowing another user to have a turn.

Wherever possible use the OS command \*FX21,0 to flush the keyboard buffer before every important keypress. The CAPS LOCK key can prove a disaster, especially when function keys are in use: use \*FX202,32 to force upper case input or \*FX202,48 if you want lower case.

The ESCAPE key can frequently lead to unwanted loss of data and/or sanity. The simplest way to avoid ESCAPE troubles is to turn it off with \*FX14,6 (turning it back on at the end of your program with \*FX13,6 to save further heartache). The BREAK key is worth an article all of its own. Some buffs suggest using \*FX247, \*FX248 and \*FX249 to insert a JMP instruction and address in the memory location the OS looks to when BREAK is pressed. For example:

```
*FX247,76
*FX248,LL
*FX249,HH
```

will direct the OS to a 6502 routine at address HLL which (hopefully) will cope with the event. (Good luck.)

### A Book for Programmers

All this discussion was brought on by reading *Using The BBC Micro in Educa-*

*tion* by Don Thorpe, distributed in Australia by Pitman. If you've ever thought about writing educational software for the Beeb or are new to using the machine in school classrooms, this book does the unusual job of reminding you of the practicalities of real-life teaching and learning. While I would question his consideration of BASIC as a serious language for programming classes (arguments on that topic will be accepted only on View files under 200K in length!), he rightly points out that if you have to learn programming in BASIC, it's better to do it with the Rolls-Royce version.

I found the most stimulating of the four sections that on designing educational programs, but this might be because I spend a lot of time doing just that. A lot of experience is evident in the hints, programs and ideas the author puts forward. So much of this advice seems obvious until you look at programs being touted to schools as 'free educational software'. Purveyors of unmarketable and uneducational trash would do well to read this book. □

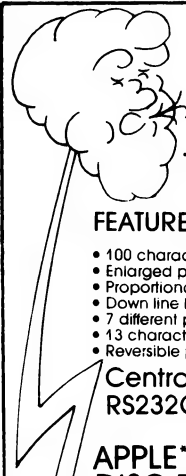

## NEW DOT MATRIX PRINTER THE ENHANCED CPA-80

**FEATURES:**



- 100 characters per second.
- Enlarged print size.
- Proportional spacing.
- Down line loadable character set.
- 7 different print modes.
- 13 character sets
- Reversible paper feed.

Centronics I/F    \$272.00  
RS232C I/F        \$289.00  
(plus tax)

## APPLE\* COMPATIBLE DISC DRIVE DISTAR

**FEATURES:**

- Apple<sup>i</sup> compatible.
- Storage capacity 250K bytes unformatted.
- Track to track 6msec.
- 35/40 track
- Half height.
- Direct drive spindle.
- Taut band head position.
- High reliability - 10,000 HrMTBF.
- Low power - 5W active, 2W standby.

73 Eric St. Goodna 4300 Qld. Australia.  
P.O. BOX 6502 GOODNA QLD. AUSTRALIA 4300  
TELEPHONE (07) 288-2455 TELEX AA 43778 ENECON

# Automatic Ice Co. Direct Connect Modem For Apple IIe.

★ Super Intelligent direct connect modem for Apple II & IIe fully contained on a single card — plugs into slot #2 — (does not require separate serial card or external line isolation device).

★ 300 Baud full duplex or 1200/75 and 75/1200 with automatic line turnaround. Provision for expansion to **CCITT Type V22 operation (1200 Baud full duplex) and V26 (2400 Baud half duplex)** with a piggyback expansion board available early 1985.

★ A full monochrome version of Prestel Videotext is implemented in EPROM as well as a limited colour version within the Apple colour display capabilities. A separate Videotext display card with the full colours and features of Prestel as well as an extended high resolution format will be available early 1985. A single key-stroke entry immediately turns the Apple into a Prestel Terminal as required by the Telecom Viatel system coming on line in 1985. The modem can operate as a full editing and composing terminal to generate and transmit pictures as an information provider as well as receiving pictures, saving or retrieving to disc and operating under a user-written program, making intelligent decisions on pictures received or sending pictures from memory or disc. Pictures can be dumped to a printer and the **Apple Scribe printer will dump colour pictures**. The firmware transmits the user ID automatically from the battery backed CMOS Ram and the ID can be remotely programmed as required by Viatel. Prestel dialling is also automatically done from phone numbers stored in the CMOS Ram.

★ A complete comprehensive communications program contained in EPROM allows easy and immediate transmission and reception of Binary files, Text files and Basic programs to memory or disc — **No other communications software is required**. All modem firmware is bankswitched into the \$C200 space and does not interfere with other program memory or disc.

★ Asynchronous or synchronous operation. Supports Bisynch, HDLC, SDLC & X25 at the link level. Flag generation, CRC error code generation & checking are all done by hardware. All registers and operating parameters are fully software programmable.

★ Can emulate Hayes Micromodem, Hayes Smartmodem, Apple serial card and Prestel terminal as well as its own modes. Conforms to the published "Firmware" standard for Apple peripheral cards and is compatible with Basic, Pascal, C/PM and machine language programs which obey the Apple standard. A fully transparent mode is available.

★ 2Kx8 battery powered CMOS RAM stores default parameters, phone numbers and log-on strings, allowing **single keystroke call establishment**. The full telephone list can be displayed from a program or the keyboard with logons/passwords selectively not visible. A further keyboard or program input can establish the link automatically and return a status message.

★ The Firmware is contained in a 64K EPROM. There is provision for an additional 64K for future expansion or special user-written routines.

★ **Onboard battery backed calendar clock** can time and initiate calls or keep an activity log. The clock is ProDos compatible and is automatically recognised. It is also accessible for other uses.

★ Optional standard telephone connection on the modem allows easy installation into existing phone plug. When the modem is not engaged the telephone acts in the normal manner.

★ Has socket for installation of DES data cypher chip for security, identification & EFT applications. *Permission is required from the American State Dept. for purchase of cypher chip.*

★ The modem contains three very sophisticated software programmable integrated circuits connected to all aspects of the hardware and a large amount of unused EPROM space. It is envisaged that additional features will be added to the firmware in future. The documentation is presently limited but the full operation of the hardware and firmware will eventually be documented.

Recommended Retail Price

**\$395.00**

including sales tax.

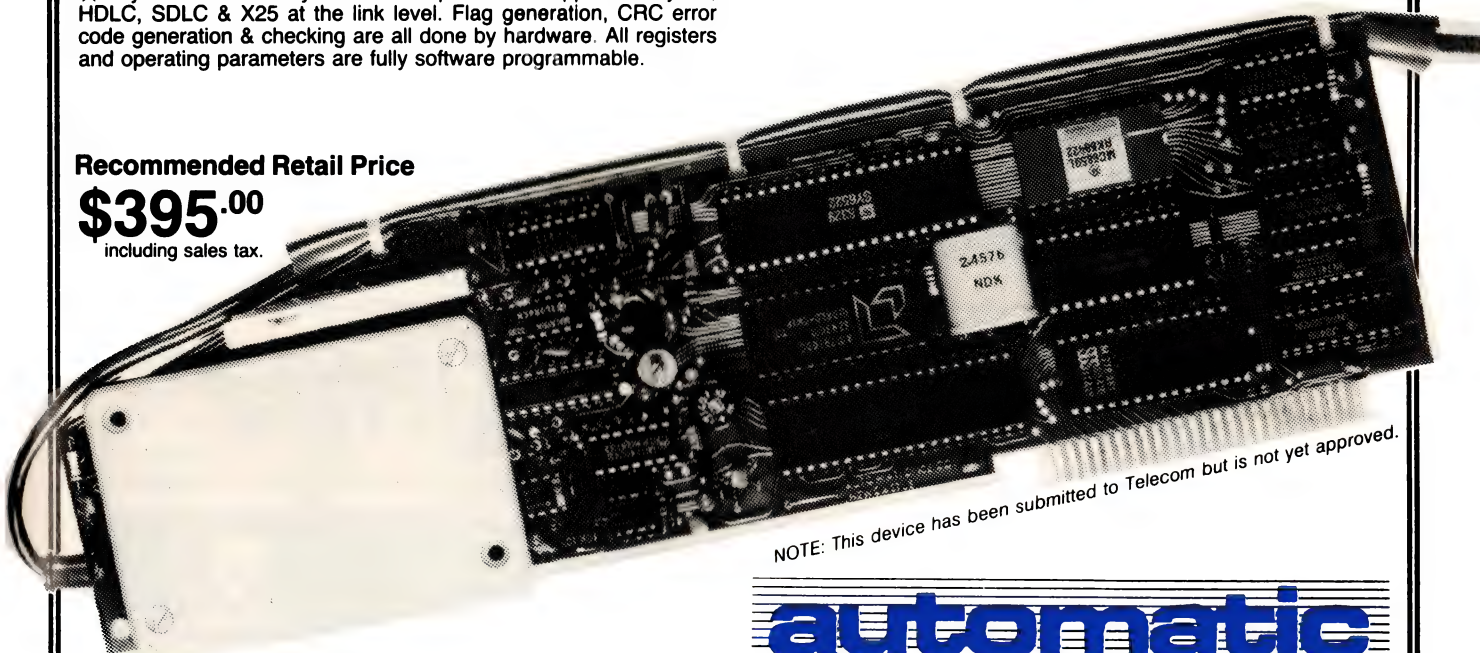

NOTE: This device has been submitted to Telecom but is not yet approved.

THE FOLLOWING UNITS WILL BE AVAILABLE LATE JANUARY 1985:

★ A plug-in card modem as above to suit the IBM PC — \$445.00 including sales tax.

★ RS232 Intelligent stand-alone modem for the Apple IIc, Commodore, Macintosh and all terminals with an RS232 port — \$295.00 including sales tax.

**automatic  
ice  
company**

10 Smith Street, Charlestown. 2290. N.S.W.  
Tel: (049) 63 3188

# LINGO 128 Vs. THE LOT

You make your own detailed comparison between the Lingo 128, the Cat, the Apple and the Basis Medfly.

When you look at the Cat in Dick Smith's supermarket, you might like to ask whether, when they say it is 95% compatible, do they mean 95% of each programme? Have a look at the August "Your Computer" review!

We have always liked the Medfly, we sold enough of them to know them well! But, when you compare the Lingo against the Medfly, ask whether the Basis Medfly organisation is still manufacturing computers?

So let's compare prices

LINGO 128 with all features on comparison table and amber monitor.

With six months' guarantee!

**\$2160**  
INC. TAX

(RETURN TO BASIS)

<b>64K Basis Medfly</b> As supplied \$1275	<b>Dick Smith's Cat</b> As supplied \$699	<b>Apple IIe</b> As supplied \$1650
<b>Features needed to build to same level as Lingo 128:</b>	<b>Features needed to build to same level as Lingo 128:</b>	With 80 column facility RGB color, printer port, single drive, controller, hi-res. monitor, average of quoted prices.
2 disk drives + controller 645	2 disk drives + controller 847	<b>Extras to bring to same level as Lingo 128:</b>
Extra 64K memory 120	Emulator required to run 99	Second drive 465
RF modulator 25	Apple software 35	64K card 578
Voice synthesizer 35	RF modulator 35	RF modulator 51
Amber monitor 220	Z80 processor for CP/M 449	Voice synthesizer 35
Custom ROMs 140	Extra 64K memory (approx) 120	<b>Total \$2779</b>
Comes with 3 mths. guarantee	Serial adapter RS232C 129	
	Voice synthesizer 35	
	Amber monitor 299	
<b>Total \$2460</b>	<b>Total \$2712</b>	

	Lingo 128	Medfly	Cat	Apple IIe
Processor	6502	6502	6502A	6502
Z80 processor for CP/M built-in	YES	YES	NO	NO
RAM memory standard	128K	64K	64K	64K
Enhanced microsoft basic	YES	YES	YES	NO
Size of interpreter in ROM	24K	NIL	24K	12K
Numeric keypad	YES	YES	YES	NO
80 column text display built-in	YES	YES	YES	NO
Voice synthesizer included	YES	NO	NO	NO
RGB color output standard	YES	YES	YES	NO
RS232 serial adapter included	YES	YES	NO	NO
Centronics printer port included	YES	YES	YES	NO
Twin drives built-in	YES	NO	NO	NO
Data capacity of each drive	164K	164K	164K	143.5K
Whisper quiet Chimon Japanese drives	YES	NO	NO	NO
Numeric keypad	YES	YES	YES	NO
Separate process for keypad	YES	YES	YES	NO
RF modulator included	YES	NO	NO	NO
Text card included	YES	NO	N A	N A

**\$2160**  
INC. TAX  
INCLUDING AMBER MONITOR

SAVINGS: LINGO 128  
COMPARED TO

APPLE IIe	\$619
MEDFLY	\$300
CAT	\$552

*And we give six months' guarantee on the Lingo 128!*

(RETURN TO BASE)

COURIER DELIVERY  
AVAILABLE



**THE IDEAL PROFESSIONAL, BUSINESS  
AND EDUCATIONAL MACHINE.**



Authorised Victorian Distributor

COME TO COMPAK  
WHERE THE BEST  
IS CHEAPEST!

**COMPAK**  
Compak Computer Centre  
THE HOME OF THE 816

350 SOUTH ROAD,  
MOORABBIN 3189  
Telephone: (03) 555 9844



## Business Bias

I NOTE WITH deep concern the increasing bias towards the business and professional spectrums in the content of your magazine. In the editorial of the first ever *Your Computer*, way back in May of 1981, you claimed that your publication was going to 'help the beginner, and make no apologies for being biased towards this little-helped group'.

Although it is true that even abject beginners who have regularly followed your periodical would have progressed greatly along the path of knowledge, I do not think that the majority of these people would be interested in the business-user biased material that has been appearing with increasing frequency over the last year.

If you have material enough to devote twenty or so pages every second month to business users, and can regularly review business machines and software packages such as Dataflex, I suggest that another magazine could be formed, freeing more pages for Pocket programs and such vital necessities as the 'Your Microbee Computer' column.

I would love to see an abrupt change in *Your Computer*. Bring back The Office Idiot, bring back Brendon Akhurst's brilliantly witty and funny cartoons, and include more Pocket Programs.

DAVID DOWNS  
Numurkah, Vic

## Can Anyone Help?

I AM LOOKING for assistance for our Association, The Australian Quadriplegic Association, to purchase a small personal computer for our Members' Services Department.

Our organisation, as well as providing accommodation, welfare and advocacy for members throughout New South Wales and interstate, employs over fifty quadriplegic people at Little Bay and Botany in Sydney.

As you are probably aware, quadriplegics have very limited use of their hands and find it difficult to write quickly and clearly. The Association has over eight hundred members in Australia and many more overseas, and we feel that a small computer would be an excellent way in which to store our members' needs and medical information.

We would be grateful if your magazine would assist us with this urgent need and would be extremely appreciative of any help your readers could offer.

CHARLES EDWARDS  
Fund Raising Manager,  
Australian Quadriplegic Association,  
1 Jennifer Street,  
Little Bay, NSW.

## PET Manual Wanted

WE HAVE A Commodore PET 2001 in our school library, and desperately need a copy of the user manual for the computer itself (we have the manuals for the disk drive and the printer). The computer model number is: PET 2001 - 32 N BS (Serial no. 1006287).

We would be most grateful if any of your readers could supply us with the manual - either to keep or to copy. We will gladly pay for the manual and/or postage.

THE LIBRARIAN  
De La Salle College,  
24 Bland Street,  
Ashfield, 2131.

## Complaining Tips

IN YOUR editorial in the November issue of *Your Computer*, you say it is totally impractical to take up the problems of the faulty C compiler with the American manufacturer. I suggest that writing directly to the manufacturer is really the only course that should be taken. I have done so twice, and on each occasion I have been more than satisfied with the results.

Each time, I sent the manufacturer a detailed description of the problems, with a short extract of the program I was compiling, illustrating the problem. The first program had been bought from America by mail order. The manufacturer sent details of some relatively minor patches, and that fixed the problems.

The second program was bought by mail order from an interstate Australian distributor whose motto seems to be roughly 'Once I've got your cash, you're on your own'. The compiler had a number of serious problems, and didn't do what the handbook said it should. I was also suspicious of the disk, because there was no manufacturer's label on the disk, and the manual was a poor photocopy.

The manufacturer asked me to return the disk directly to them so they could see the problem for themselves. I didn't hear anything from them for some months, so I wrote again. This time I received a prompt answer saying that the original disk was a very early version, and had been withdrawn from sale a long time ago.

They also said they had instructed their Australian distributor to replace the disk as soon as they had received mine, and discovered the problem. They included with the letter a replacement disk with the latest version of the software, a number of related programs and a complete new manual, with an apology for their distributor not having done so already.

In each case the correspondence in both directions was courteous, friendly and helpful.

In both cases, I'm sure that the American manufacturer appreciated the fault report, and in the second case the inference his local representative was, in effect, damaging the manufacturer's reputation by his attitude.

If I hadn't received any satisfaction from the approach to the manufacturer, I think I would have written a very fair and accurate review of the software, and sent it to one of the American magazines. I have no doubt they wouldn't publish the review without checking it themselves, and forwarding it to the manufacturer for comment. The magazines have more clout than a lonely foreigner in some backward country like Australia, and in cases where the manufacturer still doesn't fix the problem, I have seen the magazines refuse to carry any further advertisements for the product.

I strongly recommend that your readers, and anyone else with a similar problem, write directly to the manufacturer. If we don't tell them what is going on, who else will?

ALAN M. FOWLER

## Cry from a Sharp

I AM THE proud owner of a Sharp MZ-700 series computer. My father and I were planning to buy a more expensive computer until we found this, which was not only less expensive but also better than the other machine. I would like to see your magazine do a review on it because we are not experts.

I would also like to get in touch with anybody else who owns a Sharp computer to start a users' club. You can contact me on (02) 498 2426.

FERGUS BROOKS  
Killara, NSW

## What about hiring?

CURRENTLY, I'M going through the process of deciding what my next computer will be. How do I find out what the various computers are like? I can read the excellent reviews in *Your Computer*, I can talk to users who already have one or I can look at the glossy brochures from the computer companies (for what they're worth).

But how can I *really* get to know what the computer's like? Can I get my hands on one for few days to try it out? Only if I have a friend with one. Can I hire one for a week or so? If I can, the companies don't advertise the fact, and if they did, my bet is they would only hire out business micros anyway.

I can easily hire a car, TV, car trailer or rotary hoe, but I can't hire the computer of my choice. How am I expected to purchase a computer without ever having laid hands on it and given it a test drive?

There seems to be a great opportunity here for an enterprising company.

PHIL CARTER  
Warrnambool, VIC

THIS MONTH I'm coming good with all the tantalising news I promised you in the January column.

First, Data General has finally released the Data General/One Personal Computer in the US. This is the first complete, truly portable, personal computer and it's as IBM compatible as DG could make it. 1-2-3, Symphony, Wordstar, and dBase II are already available for the Data General/One, and I expect most other programs will run on it.

This box is *exciting*. A ten-pound (4.5 kg) computer with a CMOS 80C88 chip, 512K of memory, an 80-column by 25-line LCD display with 640 by 256 pixel graphics, two 720K double-density 9 cm diskette drives built in, and it runs off batteries for eight to ten hours of normal use. Yes, that's a true portable.

A portable 1.8 kg printer of near letter quality is also available. It prints graphics and characters in a number of fonts at speeds of 20 to 40 characters per second. It can use normal and thermal sensitive paper. There is also a 13 cm floppy drive available as a stand-alone unit, which enables the Data General/One to use existing PC programs and to share data with other PCs.

While the Data General/One will fit the bill for many people on the move, it should not be seen as an alternative to the PC or PC-XT. LCD screens take some getting used to. They reflect a lot of glare, and strain the eyes more than normal displays. For occasional use by someone on the move that's acceptable, but I wouldn't want to be using one day in, day out, for extended periods.

An expansion chassis will be available sometime in 1985, at which time I expect someone will put a half-height hard disk in it and a display adapter. Then the user should have the best of both worlds; fast data storage and a high quality display in the normal work place, and a true portable for working on the move.

A few words of caution. It's strongly rumoured that IBM is going to release a similar portable in 1985, and that IBM will use the Hitachi-Maxell-designed 7.6 cm diskette drives. If that happens it could spell big trouble for Data General, Hewlett-Packard, and other systems using the Sony 9 cm diskette drives.

### **Tape Back-up For Hard Disks**

Currently, users of personal computers with hard disk storage have to back up

their data using floppy disks. The integrity of floppy disks has always been questionable. Not only are they fragile, but the operator has to use up to 30 floppy disks in the correct sequence, with the whole procedure taking hours. The result is that back-ups are not adequately carried out by most users.

Since the introduction of hard-disk-based personal computers I've been evaluating alternative back-up options. Streaming tape units always seemed to be the best alternative, offering ease of use, security, speed, and the benefits of rigid packaging, but none of the units I evaluated lived up to that promise. Either the hardware, or more often the software, let them down.

Finally I've found one that works. It's the Sigma Design Streaming Tape Unit, which stores 45M on a DC300 data cartridge and 60M on a DC600 data cartridge, and can create a tape image of an IBM PC-XT 10M hard disk in under five minutes. Alternatively, the unit can back up in file mode, which allows individual files to be recovered later. In a 'worst case' test, a full 10M hard disk with some 700 fragmented files took just under one hour to back up in file mode.

Most importantly, it works. I tried it out attached to an IBM Portable PC with 256K, an IBM PC-XT with an AST Research SixPakPlus, an IBM PC-XT with a Sigma Design Maximiser, and an IBM PC with the IBM expansion unit and all sorts of other bits and pieces. The Sigma Design streaming tape unit worked perfectly in every case, regardless of the fancy software and hardware options in use.

The software driving the tape unit offers all the essential features that many leave out. Files and directories, or directories and all sub-directories can be easily backed up. A parameter file can be built and passed to the back-up program. I was impressed with the way the software provided the features and yet stayed quite easy to use.

Sigma Design offers separate controller cards to mount inside the PC-XTs or compatibles, which allows easy sharing of the tape unit between a number of computers. Alternatively, half-height ten, 20 or 32M hard disk drives can be mounted in the external subsystem along with the streaming tape drive. This provides an alternative to the Tallgrass units often used to expand the IBM PC.

The only failing of the Sigma Design

unit is the documentation. What's there is good, but there are some important omissions. For example, the software is more recent than the manual, and a number of important options are not documented. Thankfully, the software is easy to use and fairly self-explanatory.

Installing an option such as this can be difficult if the hardware or software interrupts conflict with existing options. There was no documentation to explain the nature of these problems or the way to overcome them. I tested many variations and had no problems, but if I had had difficulty there would have been nothing in reserve to call upon. That's what complete documentation is for.

What's it cost? The streaming tape drive in an external subsystem with its own power supply retails for \$3,300 including tax. The additional, short-length, streaming tape controller cards are \$675 each. If only I didn't have to hand the evaluation unit back.

### **The IBM PC-AT – First Impressions**

As I write this, the IBM PC-AT has not yet been announced by IBM Australia. Computerland has a warehouse full of ATs in Sydney, which it isn't allowed to sell. No IBM dealer has any, but a few non-IBM dealers do. I've had one for a week and experienced no problems so far.

First impressions? What the hell is that nine-pin connector for? Turns out to be a serial port! Open up the case. Oh! I thought there was a half-height 20M fixed disk – turns out to be a full-height. There is space for a second full-height hard disk, but only for one half-height floppy disk. The half-height 360K floppy drive hasn't arrived yet. When it does I'll try to find a third-party half-height 20M fixed disk to go in the remaining space.

So far I haven't been able to find an Australian source for the 1.2M floppies required. Existing 360K diskettes can be read in the new 1.2M drives. It's also possible to write to the 360K diskettes with the 1.2M drive, but then they can no longer be read in 360K drives.

The machine has eight slots, all full length. Two of the slots do not use the new bus, and the colour graphics board can only be installed in these slots. This is the 'extended' version with 512K on the motherboard, a 20M fixed disk, and a 1.2M floppy disk. One controller card is used to support all the disk drives,

and there is also a new serial and parallel port card (the one with the nine-pin connector).

The 512K on the motherboard is in 'base' memory. A special 128K board can be purchased to fully expand 'base' memory to 640K - the same as the PC and PC-XT. Any other memory boards are installed as 'extended' memory above the 1M address limit of the 8088 chip in the PC and PC-XT. When PC-DOS 3.0 runs on the PC-AT with its 80286 chip, the 'extended' memory can be used for RAM disk using the VDISK device driver IBM supplies.

PC-DOS 3.0 actually knows about Australia! There is a COUNTRY option in the CONFIG.SYS file, which is used to set the date format required. Australia is one of the countries supported. If you don't like what you get, it's tough luck. The manual doesn't give examples of the various date formats available, and it's rather tedious to try them all out.

The only problem encountered so far, is with the new PRINT command. It allows a print buffer with a default size of



The Data General/One uses Sony microfloppies; that could be a problem if IBM goes for the smaller Hitachi units.

512 bytes to be set up. That's right, 'bytes'. The manual doesn't mention an upper limit, but I soon found it has one; I usually set up a printer buffer of 64K, but the maximum allowed by PRINT is 16K, or 16384 little bytes.

This machine is fast. The only benchmark done so far was a Lotus 1-2-3

worksheet that takes 300 seconds to recalculate on the PC-XT. The PC-AT knocks it over in 110 seconds.

When the 360K diskette and additional 512K of memory arrive, the AT goes on my desk. Someone else can use my old, much extended, IBM PC. ☐

**NorthStar**  
DIMENSION

**MS-DOS  
MULTI-USER**



- FROM TWO TO TWELVE USERS
- RUNS PROGRAMS WRITTEN FOR IBM, PC & XT.
- ACCEPTS IBM COMPATIBLE OPTIONS.
- INTEGRAL DISK(S) TO 60MB.
- INTEGRAL 45MB STREAMING TAPE.
- MOUSE PORT & SPEAKER ARE STANDARD.
- ELECTRONIC MAIL.
- CACHE RAM FOR SUPER SPEED.
- BATTERY BACKED T.O.D. CLOCK.
- BIG SAVINGS OVER MULTIPLE PC OR XT's.

**START WITH USERS TWO.  
LET IT GROW WITH YOU.**

**NEW DIMENSION COMPUTERS**  
15 MAY CRT., DANDENONG, VIC. 3175.  
P.O. BOX 1167. Ph (03) 792-4152

# EASY DESK

## MOBILE COMPUTER DESK



Teak-laminated shelves. Width 900mm. Depth top shelf 300mm, depth bottom shelf 400mm. Height of bottom shelf 670mm.

**\$99**  
**DELIVERED  
TO YOUR  
DOOR!**

Name .....

Address .....

State ..... Postcode .....

Cheque enclosed Signature

Bankcard 4 9 6 .....

HC/YC

**POST TO: HOME COMPUTERS,  
160 Burwood Hwy, Upper Ferntree Gully, 3156. Tel: (03) 758 2124**

The logic expressions and functions of PerfectCalc are a useful tool for more advanced spreadsheet functions. They can be used in conjunction with the other built-in functions to provide powerful data manipulation techniques.

The most useful logic expression is the 'if' function. The format is 'if (x,y,z)', which means that the function returns the value y if x is true, otherwise it returns z. In order to understand how this works it is necessary to understand the concept of a true or false expression.

The concept of 'true' and 'false' applies in two slightly different ways. When used in an 'if' function logical expressions are simply identified as true or false. Such an expression would be 'a12>10'. This expression will be 'true' as long as the cell a12 contains a value greater than 10, and will be false otherwise. The second usage of a logic expression relies on the fact that such an expression actually returns a numeric result - 1 for a true result and 0 for a false result. Thus, as well as being true or false, logic expressions also have a numeric value that can be used in numeric expressions.

Consider an example that uses logic expressions in both contexts, such as the calculation of a salesman's commission. He will be paid \$100 commission, but only if he makes \$10,000 worth of sales in the month - at less than \$10,000 he is paid no commission. If cell a12 contains his total sales figure, the formula to calculate commission will be:

if (a12>10000,100,0).

This should be read as 'if sales are greater than 10,000 then return the value 100, otherwise return 0'.

Precisely the same result can be achieved using the knowledge that a 'true' expression returns 1 and a false expression returns 0. The formula could have been written:

(a12>10000)\*100.

This is more succinct, but also much less obvious. In this case, if sales are less than \$10,000 the expression (a12>10000) will be false, and the whole formula becomes 0\*100, or zero. If sales are greater than \$10,000, then (a12>10000) will evaluate to 1, and the expression becomes 1\*100, or 100.

In either case the expression can be extended to cope with more complex examples. Assume that if he sells up to \$10,000 he gets commission at the rate of five per cent, but if he sells more than

\$10,000 his commission rate is ten per cent. The 'if' formula becomes: if (a12>10000, a12\*.1, a12\*.05).

We can make it more complex still. Say he gets five per cent commission on sales up to \$10,000 and ten per cent on all sales over \$10,000. The 'if' expression now becomes:

if (a12>10000, 500+(a12-10000)\*.1, a12\*.05).

Now we have reached a point where the alternative form of the expression is well worth considering. Using the fact that true is the same as 1, and false is the same as 0, the same formula could be written as:

a12\*.05+(a12>10000)\*(a12-10000)\*.05. This is read as 'Five per cent on total sales, plus five per cent on sales in excess of \$10,000'. Both formulae would return the same result.

### Testing and Checking Data

Logical expressions and the 'if' function provide a means of testing or checking data. This can be particularly useful in statistical analysis. Suppose you have ten items of raw data in cells a1 to a10. A useful device in statistical work is to highlight any entries that differ from the mean by more than a given amount. This is often a useful way to identify incorrect values.

If we put the formula AVG(a1:a10) in a11, then the entry in b1 could be:

OR(a1<a11\*.5,a1>a11\*2).

This is read as 'return true if the cell a1 is less than half the mean, or more than twice the mean'. Copying (relative) this formula into b2 through b10, the sum of column b would be non-zero whenever an entry fell outside the required range. Note, however, that this arrangement will need two recalculations before it returns an accurate result.

The max() and min() functions are useful in selecting relevant data items out of a table, but they return the value of the maximum (or minimum) item, not the number of the item. By using a logic expression in which the table entry is equated with the result of the max() (or min()) function, we can determine which item has been selected as the maximum.

Using the same data as in column a, rows 1 to 10, insert the item number (1 to 10) in column b. Put the formula 'max(a1:a10)' in a11. Cell c1 can have the formula 'if (a1=a11,b1,0)', and this can be copied (relative for a1 and b1) through column c. Now put

'max(c1:c10)' in c11, and c11 will return the item number of the biggest data item (or the last biggest, if there is more than one). Again, this will require two recalculations.

Selective inclusion of items in a sum(), max() or min() function is also very easy. Say you wanted to find the smallest positive entry in a list. The easiest way is to set up a parallel list which returns the value of the data item if it matches the criteria, or returns an arbitrarily large value otherwise. For instance, using the example above cell b1 would be 'if (a1>0,a1,9E99)' and this would be copied (relative) through column b. The formula 'min(b1:b10)' in b11 would return the minimum positive entry in the range a1:a10. If using sum() or max() the formula in column b can be shortened to 'a1>0\*a1'.

If you are calculating an average and wish to exclude zero values the avg() function cannot be used. Also, the count() function is not much use, as it includes in the count cells with a zero value.

The trick is to set up a parallel column with a formula of the type a1<>0. Remembering the numeric value of true and false, this will give 1 if a1 is not equal to 0, otherwise zero. Copying this formula (relative) through column b means that you can put 'sum(b1:b10)' in b11, to give the number of non-zero entries in column a. If a11 is 'sum(a1:a10)', then the average of the non-zero entries is a11/b11. This technique is very useful when doing statistical analysis on data when the number of data items cannot be known in advance, or may vary throughout the analysis.

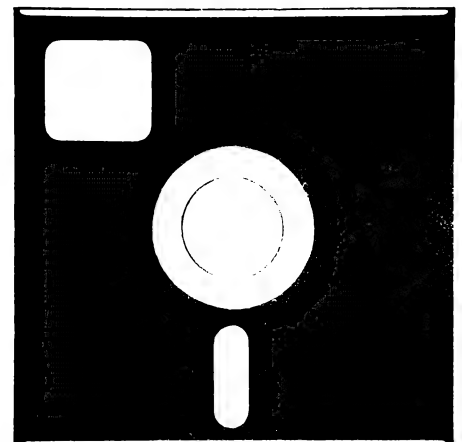



## Independent CP/M

A number of 16-bit computer systems have MS-DOS implemented for them, but there's no CP/M-86 implementation. James Trill from JDT Systems in Melbourne has developed what he calls 'Independent CP/M' for just this situation.

Independent CP/M is a full implementation of CP/M-86 which loads under MS-DOS and uses the MS-DOS I/O system as if it were the CP/M-86 BIOS (with suitable filtering, of course). As both the MS-DOS and CP/M-86 operating systems are resident in memory at the same time, the user can (carefully) use operating system calls from either. This has made it very easy for JDT to provide a utility to transfer files between CP/M and MS-DOS disk formats.

I tried Independent CP/M on the new NEC APC III. All my CP/M-86 applications and utilities ran faultlessly, and Independent CP/M came with several useful utilities for both MS-DOS and CP/M-86. There is also an optional CP/M-80 software emulator which runs under CP/M-86. As expected, the emulation was slower than a 4 MHz Z80-based CP/M-80 system (though on the 8 MHz 8086 in the APC III it wasn't that much slower), but it ran several CP/M-80 programs I tried without any problems.

JDT Systems also has other software tools available. There is a greatly improved MS-DOS for the Sanyo MBC 550, which includes support for both 40 and 80-track drives, much faster screen handler (it's worth it just for this alone), better keyboard buffering, interrupt-driven printer buffering/despooling, and improved compatibility with the IBM PC (though even with this improved MS-DOS, the MBC 550 still can't be called an 'IBM compatible' by any measure).

All the software has been developed in Australia. Independent CP/M and other software support tools from JDT Systems are available for a number of MS-DOS machines. JDT can be contacted at PO Box 431, Ringwood 3143.

## PAMS News

There are three new systems this month. Tasmania gets its first PAMS system with Mike Scott's Tandy CP/M-based BBS system, located in Launceston. I logged onto the system but didn't get too much of a chance to have a look around as Mike was still having trouble with his communications supervisor software; however, all that should be fixed by the time you read this.

Brisbane's second PAMS system is Ian Bennet's Tomorrowland Remote MS-DOS system. The Tomorrowland system is using software that Ian developed himself and requires that you register a verifiable address before you can get through the log-in password procedures, but you can dial up the system to get a message telling you what to do to register as a user. I have been using this system quite a bit lately and have watched the software develop as Ian spots and corrects the problems and adds enhancements.

The last new system is the Tesseract RCPM system in Sydney. John Hastwell-Batten has been threatening to put a system on-line for several months now and has finally rounded up the hardware to do it. This system was due to go on-line early in 1985.

The Sorcerer Computer Users' Association RCPM system has confirmed that its system is running again and the number is back in the PAMS list below. To keep up to date with the newest systems look for a file called AUST-PAMS.DOC or something similar on your favourite PAMS system.

## PAMS Numbers

### Australia

Software Tools RCPM (ST-RCPM), (07) 378 9530 24 hours EST  
Tomorrowland RMS-DOS (TL-RMSD), (07) 286 2438 24 hours EST  
Mi-Computer Club BBS (MiCC-BBS), (02) 662 1686 24 hours EST  
Micro Design Lab RCPM (MDL-RCPM), (02) 663 0151 24 hours EST  
Sydney Public Access RCPM (SPA-RCPM), (02) 808 3536 24 hours EST  
Sydney Osborne UG (AUSBD-RCPM), (02) 95 5377 24 hours EST  
Tesseract RCPM (TES-RCPM), (02) 651-1404 24 hours EST  
Sorcerer UG (SUG-RCPM) 'Ring Back', (02) 387 4439 1800-0800 weekdays, 0800-2400 weekends EST  
Omen RTRS (OM-RTRS), (02) 498 2495 1630-0900 + 24 hours weekends  
Sydney TRS-80 UG RTRS (STRUG-RTRS), (02) 332 2494 24 hours EST  
Prophet BBS (PROPHET-BBS), (02) 628 7030 24 hours EST  
Dick Smith Electronics (DSE-BBS), (02) 887 2276 24 hours EST  
Sydney Apple UG (AUG-BBS), (02) 451 6575 24 hours EST  
Texas Instruments UG (TISHUG-BBS), (02) 560-0926 Restricted hours  
Oracle RTRS (ORACLE-RTRS), (02)

960 3641 0-1800 weekdays, 0-0800 weekends EST  
Newcastle RCPM (NCLE-RCPM), (049) 68 5385 1700-0830 + 24 hours weekends EST  
Canberra RBBS (ACT-RBBS), (062) 88 8318 24 hours EST  
Melbourne CBBS (MICOM-CBBS), (03) 762 5088 24 hours EST  
TARDIS RCPM (TARDIS-RCPM), (03) 67 7760 1800-0800 + 24 hours weekends EST  
Sorcerer CUA RCPM (SCUA-RCPM), (03) 434 3529 24 hours EST  
East Ringwood RCPM (ERING-RCPM), (03) 870 4623 1600-2400 daily EST  
PC Connection IBBS (PCC-IBBS), (03) 528 3750 24 hours EST  
HiSoft IBBS (HISOFT-IBBS), (03) 799 2001 24 hours EST  
Computers Galore IBBS (CG-IBBS), (03) 561 8479 24 hours EST  
OMEN IV RTRS (OM4-RTRS), (03) 846 4034 24 hours EST  
Gippsland RCPM (GL-RCPM), (051) 34 1563 24 hours EST  
Gippsland MAIL BUS (GL-MBUS), (051) 27 7245 24 hours EST  
Mike Scott's BBS (MS-BBS), (003) 34 9411 24 hours EST  
Adelaide Micro UG BBS (AMUG-BBS), (08) 271 2043 1000-2200 CST  
Computer Ventures BBS (CV-BBS), (08) 255 9146 24 hours CST  
Outback RCPM (OUTB-RCPM), (089) 27 7111 24 hours CST  
OMEN II RTRS (OM2-RTRS), (089) 27 4454 24 hours CST  
OMEN III RTRS (OM3-RTRS), (09) 279 8555 0800-2400 + 24 hours weekends

### New Zealand

Attache RBBS (ATT-RBBS), ISD: 64 9 78 9084 24 hours NZT; Domestic: (09) 76 9084

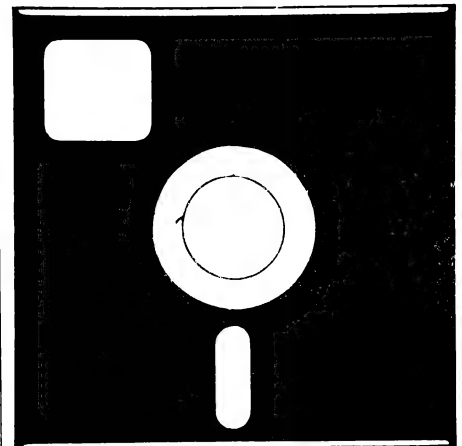



# SANYO OWNERS!

## MBC 555 PROFESSIONAL UPGRADE

From 360K Floppy to 11 meg Hard Disk  
for only \$2495 including Tax.

Bring in your Sanyo with its inadequate Floppy drive to convert to a truly professional system. Turn 360K capacity into an incredible 11250K capacity. That's over 30 times the storage — 30 times the user capacity. Mr. Hard can build-in the new 11¼ meg Microscience Hard Disk Drive into your existing Sanyo

for only **\$2495** \* inc. Tax.

## NEW SANYO BUYERS!!

Purchase the MBC555 from Mr. Hard giving you a complete professional system for only **\$3990** \* inc. Tax.

### MBC 555 + Hard Disk features:

- 11250 K storage • IBM disk compatible
- Centronics port standard • MSDOS
- 256K memory upgrade • 8088 Processor — 16 bit



Hard disk drive service and repair in Australia's only HDA "Clean room" facility.

### Factory Options

- 720K Drive Upgrades — Call NOW
- 128K to 256K upgrade — \$150\*
- Single Serial Port — \$120
- Double Serial Ports — \$240

\*All prices Rec. Retail incl. Sales Tax.

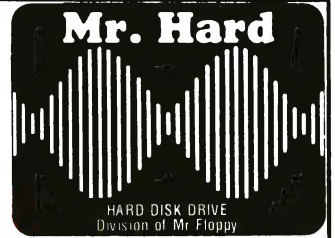

## Mr. Hard

HARD DISK DRIVE division of Mr Floppy

35 CARTER RD., BROOKVALE, 2100

**(02) 939-1800**

★ INTERNAL IBM HARD DISK UPGRADES AVAILABLE — CALL NOW FOR DETAILS.

MUSIC SOUND RECORDING STAGE LIGHTING

# SONICS MAGAZINE

For: Musicians, Road Crews,  
Recording Engineers, Lighting People,  
Managers, Promoters and anybody  
interested in what goes into  
today's music-making.

THE ALL AUSTRALIAN  
MUSIC MAKERS' MAGAZINE

Published quarterly, in April, July,  
October and January, with a NEW  
expanded Yearbook in early March.

## JANUS/Ada

- The most comprehensive Ada implementation for CP/M, CP/M-86 and MS-DOS is now available with software floating point libraries (and 8087 support for 16 bit).
- The 16 bit versions will be developed to validated standard, and upgrades will be available through maintenance agreements.
- Powerful features soon to be released — exception handling, operator overloading and generic packages.

## MODULA—2

- Volition Systems Modula — 2 for Apple, IBM-PC and SAGE now available from \$452 including tax.

## FOR APPLICATION PROGRAMMERS

- Phact-DBRM, a "C" library for database management. These library routines for dictionary and record management make easy work of application development in "C".

### ADA AUSTRALIA

218 Lutwyche Road, Windsor, Qld. 4030

(07) 57-9997 Agents in most states

**Write Off Theft:** Protect your micro, video etc. With the revolutionary marker pen, invisibly mark your telephone number or other identifier. One pen will identify most items in your home/school/company. Only readable with a U.V. light. \$8.50 each. Frazer Electronics. P.O. Box 485 Ringwood, Vic, 3131.

**Vic 20 Software:** Intro to Basic P+1 \$18, Sargon Chess Cart \$25, Mars, Pyramid, Home Inventory \$10. Books: Prog Ref Guide \$15, Innovative Comp, Vic 20 Revealed \$9. Hardware: T.J.'s 24K RAM Board \$90. A. Hogan, PO Box 697, Casino, 2470; (066) 621416, 623802.

**Microbee 32K:** Green screen monitor, datacassette, joystick, software, carrycase, games book, magazines. Excellent condition. \$620. Mark (042) 61 4636.

**Vic 20:** Program library. High quality games, utilities, educational and miscellaneous programs available. Send SAE to Chris Groenhout, 25 Kerferd Street, Watson, 2602 for list.

**IBM-PC and Apple compatible software:** All types including Lotus 1-2-3 and Zardax wordprocessor programs all under \$100. P. Pascoe, 23 Yerrawa Drive, Watsonia VIC.

**Microbee Quality Software:** 'File Index' handles name and address based records with provision for 4 lines of user inserted text. Searches in alpha sequence, or by keyword, by

single postcode or within postcode groups. Records may also be edited or deleted. Suits popular printers; will print full record or mailing labels. Tape \$15, disk \$19.95, post paid, with full instructions. Mail order to B. Proctor, 27 Roberts Avenue, Mortdale, 2223. Prompt return guaranteed.

**Microbee Quality Software:** 'Accounts Manager' is a cashbook providing itemised dissections of up to 32 user named accounts. All entries are automatically sorted into correct data sequence. Suits popular printers; will print individual account reports or consolidated cashbook. Suitable for private and commercial use as a well-formatted record of income and expenditure. Tape \$15, disk \$19.95, post paid, with full instructions. Mail order to B. Proctor, 27 Roberts Avenue, Mortdale, 2223.

**Microbee Quality Software:** 'Stock Supervisor' is an on-line inventory system allowing for entries as goods are issued and received. Usual stocktaking/bookkeeping aspects of stock control includes item-extended totals, grand totals, individual and average product margins, etc. Produces three separate reports: complete stocktake, price lists, inventory count. Will assist in identifying under- and overstocking. Tape \$15, disk \$19.95, post paid, with full instructions. Mail order to B. Proctor, 27 Roberts Avenue, Mortdale, 2223.

**Microbee Quality Disk Software:** 'Crossword Puzzle Generator' can construct hundreds of different puzzle patterns to suit skill levels for preschooler to advanced player. General knowledge word list provided. This can be extended, or new lists easily created to cater for specialty topics, individual's comprehension, etc. Disk \$19.95, also contains 'Anagram' and 'Cryptogram' programs. Mail order to B. Proctor, 27 Roberts Avenue, Mortdale, 2223.

**Spectravideo Software:** SV38 cartridge copier, makes backups of your cartridges; no hardware modifications; tape/disk - \$49. Versions of Pacman, Frogger and Breakout - \$10 each or all three for \$25. SV328 Coleco cartridge copier, modify your Coleco adaptor to make backups of your Coleco cartridges; tape/disk - DIY booklet \$20, or send your adaptor for modification - \$60. Brian Parker, 19 Barcelona Street, Wishart 4122. (07) 349 0315.

**Apple II+:** Plug-in cards for sale. Digitek PAL Colour UHF Card \$160 ono; Serial Interface Card RS232 \$35 ono. Sendata 300 BPS Direct Connect Modem \$180 ono. Kaga 12" Green Screen \$180 ono. (03) 592 1968.

**System 80/TRS 80 programs:** For information contact Raymond Schatz, 53 Yass St, 2594.

**Hitachi Peach MB-6890:** 16K Expansion, SS/SD disk drive, green screen, Sendata 700 acoustic coupler and software (Hi-writer, financial, Graphics Expander, editor, games) \$1650 ono. (075) 572028.

**Microbee 32k:** With Wordbee, Edasm, Green Screen, Datatree computer tape recorder, Joystick and over \$200 software. All for \$600. (02) 869-1113.

**Apple II:** Software for swapping by mail. Send list to David Chu, 22 Jacobson Ave, Kyeemagh, 2216. Over 85 disks.

**Apple Software Wanted:** Copy of program to do ledgers, accounts etc. Applesoft or CP/M. Please contact Anthony Gabb, P.O. Box 736, Casino 2470.

**Microbee:** Unwanted original software. Ztrek, Chess, Robotman, Pilot, Escape from Colditz - \$6 each. Chopper, Kilopede, Sydney Approach - \$8 each. J. Arnold (02) 625 8950.

**Software:** For all TRS-80 and System-80 micros. (07) 354 1619 or write to 51 Fallon Street, Everton Park, Queensland 4053, and send a cheque for \$2 for your catalogue.

**Modifications, Repairs and Upgrades:** To home computers, specialising in Microbee and Apple II (or lookalike). Also burn EPROMS and build and repair add-ons. Rates from \$15 an hour, plus parts and travel. Fix 'n' Chips, Petersham, NSW. Ring Lindsay on (02) 569 4410; 8am-10am, 5pm-9pm.

**VZ200 software:** Cash Book Ledger, Utilities Security, etc. Hardware for sale, CIO tapes. Send SAE to Mr. J.D'Alton, 39 Agnes St, TOOWONG 4066.

**Apple compatible disc drive:** Never used. \$220. (043) 84 3925.

**Wanted:** To contact anyone with a SORD 100/ or 200 ACE Computer, aim Software Swaps etc - or anyone with CAM 80 running on SORD 100 ACE. Write G.E. Smith, 48 Rutherford St, Blacktown 2148.

**Games for Most Micros:** Send SAE to 2 Hammond Place, Campbelltown, 2560 for list. Some Commodore equipment available; near new.

**Wanted:** Visicalc for TRS-80, Model 1 (level 2). Bob Leeser, phone, (02) 922 4000 or (02) 498 1710

## MicroBee Games

### BUNYIP ADVENTURE

Escape the city life in this absorbing Australian adventure in which you must face the challenge of the outback in search of the bunyip.

**\$20.00** Requires 32K



### GROTNIK WARS

Grotnik Wars is a high-speed three-dimensional video-game set in the surreal wastes of deep space. What you see on the screen is the view from your spaceship.

**\$20.00** Requires 16K

Post Free. No credit cards.

Send a cheque or money order to: Grotnik™ Software, P.O. Box 372, Glenside 5065, South Australia.

# market directory

DEALERS, distributors, mail-order houses and other commercial organisations or individuals who have a message to spread but don't want to outlay the sums required for full-scale advertising can take advantage of our Market Directory — small ads to help those searching for outlets, services and equipment. For details contact *Your Computer* on (02) 662-8888 or write to PO Box 21, Waterloo 2017.

**commodore**  
computer centre

SERVICE **VIC 20 & 64** SALES

- Prompt repairs by friendly experts
- Easy Access
- Plenty of parking
- Open Saturday mornings
- Established 1968



Melbourne's largest range of Computers, Programs, Printers, Disc Drives, Monitors, Plotters, etc.

**TELEPHONE: 419 6811**

**Maxwell OFFICE EQUIPMENT (VIC) PTY. LTD.**  
162 - 164 NICHOLSON ST.  
ABBOTSFORD  
(Near Collingwood Football Club)

**COMPUTER SYSTEMS (AUST) P/L**

Conduct your CP/M with more power than ever before!

- MDRIIVE — ADD AN EXTRA DISK, FASTER THAN HARD DISK
- CACHE Q
- CP/M 3.0
- 8 MHz CPU UPGRADE
- MICROHELL
- JRT PASCAL 3.0
- CP/M USER GROUP LIBRARY
- ACCOUNTING SOFTWARE IN SOURCE CODE
- PCB DESIGN SOFTWARE FOR CP/M

ADD-ONS AND UPGRADES GALORE



140A Victoria Rd., Gladesville 2111.  
Phone: (02) 816-4044

CALL DAMIEN PRINS NOW FOR YOUR MARKET DIRECTORY ADVERTISEMENT.  
(02) 663 9999.

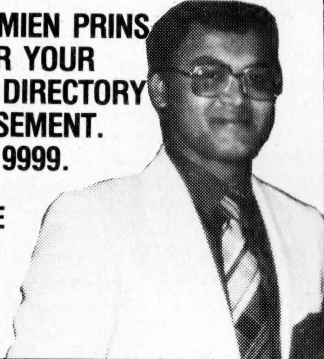

THIS SIZE FOR A LOW LOW COST.

**NEW**

**MICROMASTER SBC \$495\***

A new complete single board computer specially designed for system integrators, OEMs, educators, and hobbyists.

- Z-80B CPU at 6 MHz
- 64K RAM
- Floppy disk controller for both 8" and 5" drives
- 2 Serial Ports
- Centronics printer port
- Clock calendar
- Hard disk adapter (optional)
- DMA controller (optional)
- Improved CP/M compatible op system.

Available as board only or as complete system.  
• Introductory special plus sales tax.

**Microtrix Pty. Ltd.**  
24 Bridge Street, Eltham. 3095  
(03) 439 5155.

**THE FORTH SOURCE**

All Fig publications

MVP Forth books and software

Laboratory Microsystems Forth

Send for catalogue

**COMPUTER REALM P/L**  
1/100a Young Street, Frankston 3199.  
P.O. Box 103, Camberwell 3124  
(03) 29 2600

**RS232 — ALL PROBLEMS SOLVED!**

**The RS232 Tester** — helps with computer interface problems: Simple to connect; No power needed; displays transmit data.  
**\$38 + Tax** Call for details.

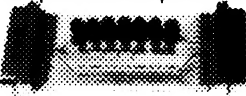

**The RS232 Bit Switch** — designed for versatile interconnection of RS232 devices — "One in", "Three out" change-over switch (bi-directional).

Call for details. From **\$108**  
+ Tax if applicable.



**M.F. Computers 9 Ada Ave, Brookvale, 2100**  
Ph: (02) 939-1800  
Telex: AA 73775

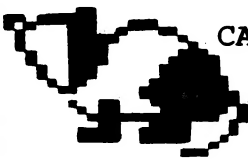

**CALYPSO JANE SOFTWARE**

P.O. Box 160  
St Peters. 2044

\*Specialising in individualised science education materials.  
D.C.CIRCUITS KIT (Apple II edition)  
\*class set of instruction cards.  
\*accompanying computer disk.  
\*comprehensive teaching manual.  
SPECIAL INTRODUCTORY PRICES  
AT CONASTA XXXIV

**RENT IBM SOFTWARE**

Symphony ...	\$58.05 (B)	Sargon III ....	\$4.50 (G)
Lotus 123 .....	\$43.65 (B)	Flight SIM ...	\$5.22 (G)
C Compiler ...	\$13.50 (B)	Pinball .....	\$4.95 (G)
Copywrite .....	\$6.03 (B)	Pig Pen .....	\$2.61 (G)

Join the Down Under Software Rental Library, and save on all your IBM Software. You pay only 9% of the dealer wholesale price. Join the Games Library (G) for only \$25; join the Business Library (B) for \$30; or join both for only \$35. Start saving now — your very first rental (including joining fee) will probably be less than buying the equivalent program.

**Down Under Software**  
1 Botherambo Street,  
Richmond. Ph.: (03) 429-3216.

**DISK COPYING**

as low as  
**\$7.00** (+ p & p)

(less than 100K data CPM to CPM)

CPM, MSDOS, DEC, IBM

**TETRAD SYSTEMS**  
P.O. BOX 594  
FRANKSTON 3199

**LETTERS TO THE EDITOR:** We are happy to receive your comments and, if they are of interest to other readers, publish them. Letters will only be considered for publication if they include your name and address, although we can withhold such details from publishing on request. Note that we reserve the right to (and probably will) edit all letters for the sake of brevity, clarity or accuracy.

**SUBSCRIPTIONS:** Standard 12-issue rate within Australia: \$24. Surface rate for New Zealand and Papua New Guinea: \$32.60; air-mail rate: \$41.60. Save more on two years' subscription: Australian rate \$42; surface rate to New Zealand and Papua New Guinea: \$59.20; airmail rate: \$81.20. Rates for other countries on application. All overseas rates quoted are to be paid in Australian dollars. Allow up to eight weeks for subscription processing.

**BACK COPIES:** and single issues are available from the publisher's office (\$2.50) or by mail (\$3). We will supply photostat copies of articles where a back issue is not available, at the single-magazine price for each feature copied.

**READERS' ENQUIRIES:** We will make every effort to answer readers' written enquiries, if accompanied by a stamped, self-addressed envelope, although staff shortages and deadline pressures may cause delays. Please include your telephone number(s) with any enquiry. Phone enquiries not related to subscriptions, readers' advertisements, or other 'service information' cannot be accepted.

**COPYRIGHT:** All material appearing in *Your Computer* magazine is copyright and cannot be reproduced in part or in full, by any means, without the written permission of the Publisher or Managing Editor. Computer clubs and schools can, however, apply for restricted permanent reproduction rights for non-commercial, limited-circulation use (for example, newsletters and class instruction). Given that it sometimes takes us a while to answer such requests, you can consider that restricted permanent rights apply in these cases from the day you send in your letter, and will later be confirmed (or withdrawn) by our reply.

**LIABILITY:** Although it is policy to check all material used in *Your Computer* for accuracy, usefulness and suitability, no warranty, either expressed or implied, is offered for any losses due to the use of any material in this magazine.

**EDITORIAL CONTRIBUTIONS:** Contributions to *Your Computer* are welcomed and will be given every consideration\*. Please read these notes carefully to get an idea of the style and format we prefer.

**All Contributions:** should include your name, address, and home and office phone numbers (in case we need to check details). Each page of your submission, and any material sent with it, should also carry your name.

**Contributions by Telephone:** Contributors who have modems and suitable software (in the MODEM7/YAM mould - see our stories on Christensen Protocols in the May and June 1983 issues) can arrange direct transfer to our computers through our Bulletin Board system, which is on-line 24 hours a day, seven days a week. Contact our office by phone for details on transferring material in this way.

**Contributions on Disk:** Contributions can be accepted in a wide variety of disk formats, although some have to be converted outside our offices, which will add to the (often lengthy) delay between receipt and acknowledgement. The preferred medium is IBM standard format single-sided, single-density, 20 cm CP/M disks. We can also handle, in-office, IBM, MicroBee, Kaypro II and Osborne 13 cm disks, and 13 cm Apple DOS or Apple CP/M disks. If you have one of the formats listed by Compotron in Brisbane (usually advertised in this magazine), we can accept that too. Please pack them extremely carefully if posting and label all disks with your name, address and phone number.

**Listings:** Unless it is absolutely impossible, we want listings produced on the computer. This reduces the risk of error - if the computer typed it, the computer probably accepted it. Print listings with a dark - preferably new - ribbon on white paper, and try to format the output to a narrow (40-character) width. If they can't be produced on a printer, borrow a good typewriter - hand-written material is likely to sit around the office for a year before someone can find time to type it all out for you! Please provide an account of what the program does, how it works and so on. Any comments on the program should refer to the address, line number or label rather than to a page number. Any comments on modifying the program to work on other machines will be appreciated. Try to include a printout of at least part of a sample run if possible.

**Style:** All items should be typed (or printed) and double-spaced on plain white paper. We will only accept original copies - no photostats. Include your name, address, telephone number and the date on the first page of your manuscript (all manuscript pages should have your surname and page number in the top right-hand corner). Be clear and concise, and keep jargon and adjectives to a minimum.

\*Although the greatest care will be exercised with contributions, no responsibility can be accepted for the safety or return of any letters, manuscripts, photographs or other materials supplied to *Your Computer* magazine. If return is desired, you should include a stamped, self-addressed envelope. If return is critical - say it's something you can't afford to lose - then don't send it; we are careful, but we're not perfect. □

## AD INDEX

ACT .....	OBC
AED Computers .....	82
AID Systems .....	11
All States Computer .....	15
ANZ Books .....	68
Applied Technology .....	18
Arcom Pacific .....	45
Aust Video Presentations .....	76
Aust Computer Society .....	106
Automatic Ice .....	117
Automation Statham .....	109
AWA Computer .....	95
AWA Thorn .....	74
Award Software .....	108
Barson Computers .....	46
Bi-Computer Company .....	55
Breeze Software .....	13
CAE .....	76
Classifieds .....	128
Commercial & Professional .....	72
Compak Computer Centre .....	118
Consultech .....	90
CP/M Systems .....	127
Cypher Research Lab. ....	114
Datatel .....	60
Dick Smith .....	88
Electromark .....	81
Emona Computers .....	50
Energy Control .....	116
Entercom .....	30
Federal Marketing .....	98, 125
Gambit Games .....	114
Grotnik .....	128
Hi-Tech Software .....	5
Home Computer .....	123
Immedia .....	93
Intelligence Australia .....	90
Labtam .....	26
Logo Computer Centre .....	14
Mac Designs .....	12
Market Directory .....	129
Micro General .....	114
Mr. Floppy .....	127
New Dimension Computers .....	123
Nissei Sangyo .....	60
Nucleus .....	60
Olivetti .....	22
Osborne .....	28
Output Media .....	120
Pitman Publishing .....	72
Porchester Computers .....	66
QT Computing .....	56
Qubie .....	IBC
Ritronics .....	65
Roland .....	IFC
Rose Music .....	102
Siemens Industries .....	34
Six-S Business Advisory .....	112
Smith Corona .....	104
Software City .....	42
Software Specialists .....	105
Software Suppliers .....	62
Synax Systems .....	61
Utilico .....	114
VIC Centre .....	108
Warburton Franki .....	70

America's  
leading  
distributor of  
IBM P-C  
accessories  
is now  
supplying  
your  
IBM dealer  
locally. . .

Heralding  
this announcement  
is the introduction  
of the Qubie'  
10 Megabyte  
Winchester Hard  
Disk Drive for  
the PC-1 & PC-2  
**QUBIE' PC10**  
with 10 Megabyte  
hard disk, controller,  
cables, installation  
hardware and  
instructions.  
1 year warranty.  
**\$1,995** inc. tax

**NOW IN  
AUSTRALIA  
QUBIE'**

Also available: IBM PC key boards, multifunction memory boards and Modems.

**NOW IN AUSTRALIA:** 9/62 Blackshaw Avenue, Mortdale, 2223 - Phone: (02) 579 3322

**U.S.A.:** 4809 Calle Alto, Camarillo, CA 93010

**U.K.:** Tempo House, 15 Falcon Road, London, SW11 2PH, United Kingdom

# ANOTHER HARD ACT TO FOLLOW!



## Act's fixed removable disk systems give you MEGABYTES IN THE PALM OF YOUR HAND

### COMPATABILITY

No matter which micro you have, you can make it ACT. The ACT fixed removable winchester is compatible with most micros —

- APPLE I & IIE • COLUMBIA P.C.
- CORONA/WORDPLEX • DEC RAINBOW 100 • HEATH/ZENITH H89/Z89 • HITACHI PEACH • IBM P.C. • KAYPRO • MICROBEE
- MORROW MICRO-DECISION • NEC APC • NORTHSTAR ADVANTAGE & HORIZON • OSBORNE I & EXECUTIVE
- SANYO MBC-1000 & 555 • SIGMA/OKI MODELS 20 & 30 • SIRIUS • SUPERBRAIN I/II • TANDY II & III • TIME OFFICE
- TOSHIBA T-300 • XEROX 820
- PANASONIC JB-3001 • AND OTHERS.

### A GREAT STORAGE SYSTEM

Combine the best of two storage systems — the speed and capacity of a hard disk and the mobility of a floppy.

You can backup the days data, remove the disk and store it safely or carry it interstate in your briefcase — a great storage system!

### AUSTRALIAN

You don't have to pay more to buy Australian!

ACT is manufactured in Australia and supported by an Australian organisation committed to backup support and service. It's a professional ACT.

A DIVISION OF AUSTRALIAN PROTECTION INDUSTRIES

# act

Australian Computer and Telecommunications  
75 Willoughby Road, Crows Nest, NSW 2065.  
Telephone 02 439 6300, Telex AA 24816